

Prime - Pont 21

**bobcat of dayton inc.**

2850 EAST RIVER RD. • DAYTON, OHIO 45439

(937) 293-3176

1-(800) BOB-CATS

(937) 391-6734 PAGER

**ED EADES**

CUSTOMER SERVICE



**bobcat**

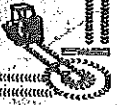

895  
5061

# Operation & Maintenance Manual

## 853

8

5

3

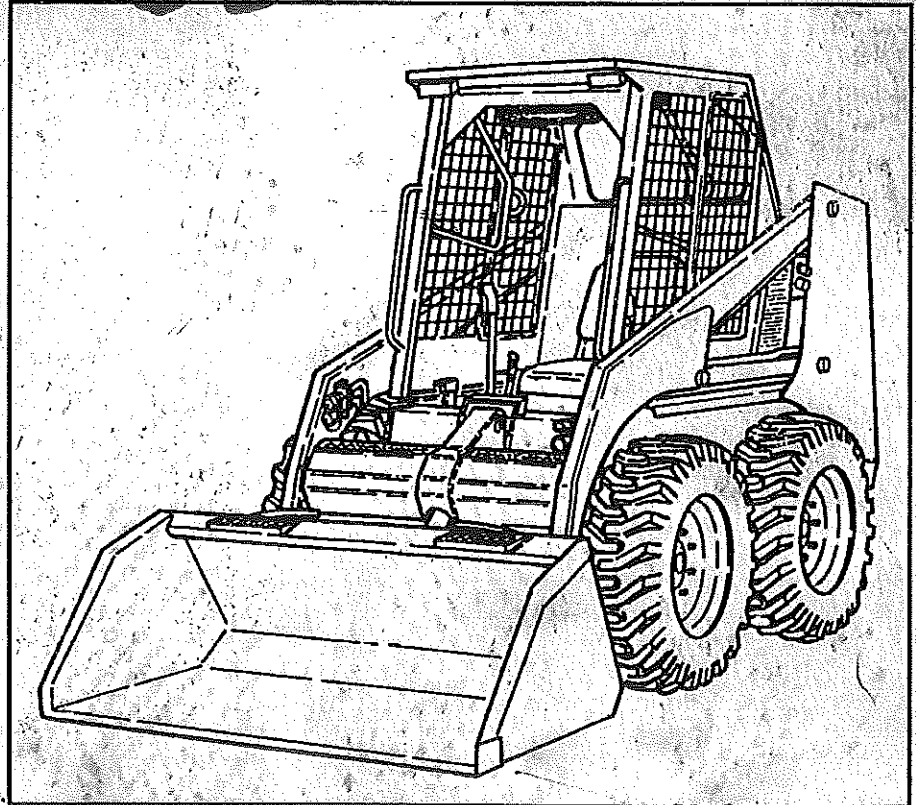

**MELROE  
INGERSOLL-RAND**

6722906 (2-94) Revised (10-97)

Printed in U.S.A.



**bobcat**

© Melroe Company 1997

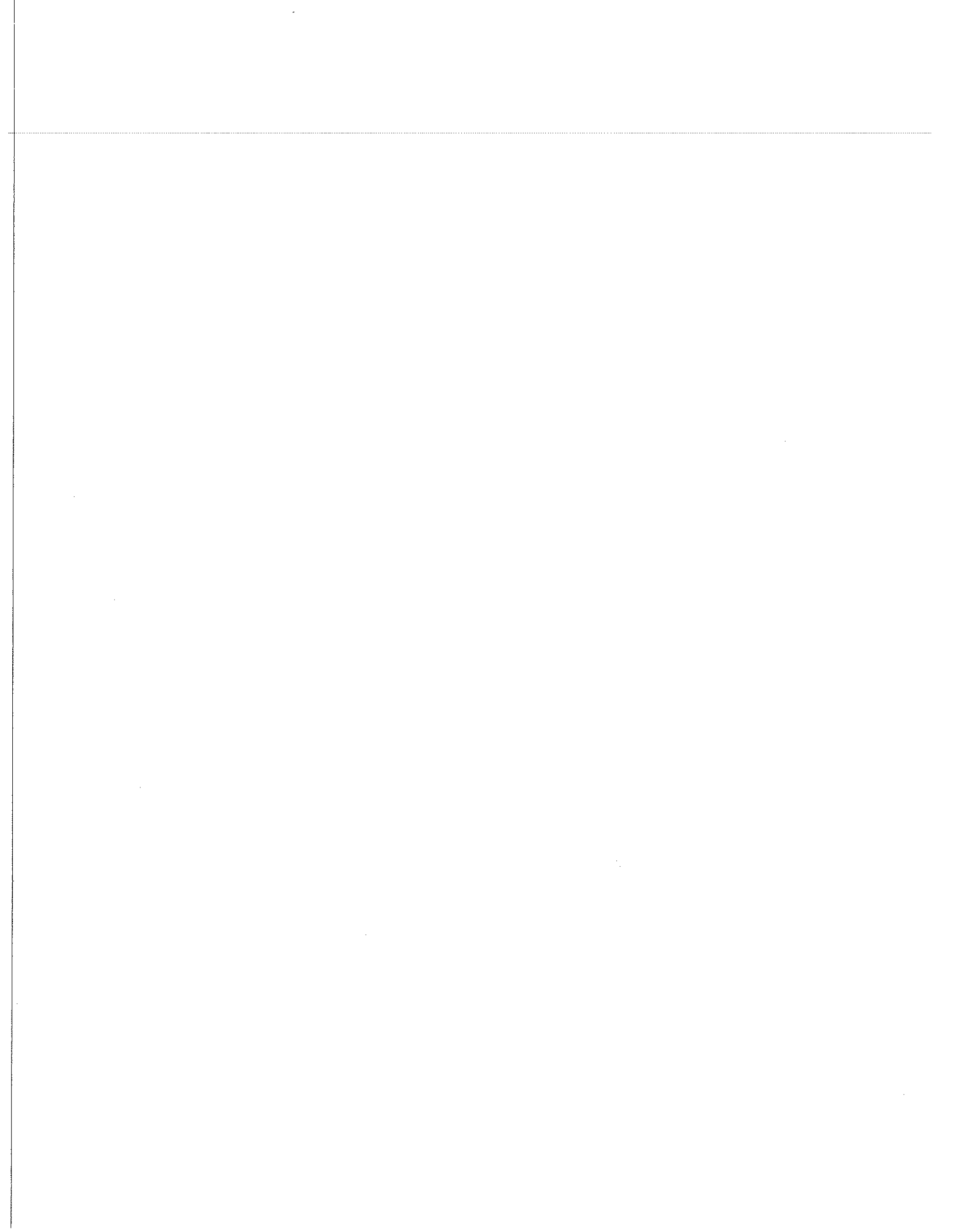

# CONTENTS

FOREWORD .....	iii
SAFETY .....	xi
OPERATING INSTRUCTIONS .....	1
PREVENTIVE MAINTENANCE .....	29
SYSTEMS ANALYSIS .....	57
MACHINE SIGN TRANSLATIONS .....	61
SPECIFICATIONS .....	71

**FOREWORD**

**SAFETY**

**OPERATING INSTRUCTIONS**

**PREVENTIVE MAINTENANCE**

**SYSTEMS ANALYSIS**

**MACHINE SIGN TRANSLATIONS**

**SPECIFICATIONS**

**CALIFORNIA  
PROPOSITION 65 WARNING**  
Diesel engine exhaust and some of its constituents are known to the State of California to cause cancer, birth defects and other reproductive harm.

## REFERENCE INFORMATION

Write the correct information for YOUR Bobcat loader in the spaces below. Always use these numbers when referring to your Bobcat loader.

Loader Serial Number ..... \_\_\_\_\_  
Engine Serial Number ..... \_\_\_\_\_  
\_\_\_\_\_  
\_\_\_\_\_

**NOTES:** \_\_\_\_\_  
\_\_\_\_\_  
\_\_\_\_\_  
\_\_\_\_\_  
\_\_\_\_\_

**YOUR LOADER DEALER:** \_\_\_\_\_  
**ADDRESS:** \_\_\_\_\_  
**PHONE:** \_\_\_\_\_

Melroe Company  
P.O. Box 128  
Gwinner, ND 58040-0128

Melroe Europe  
J. Huysmanslaan 59  
B-1651 LOT  
BELGIUM



15 98  
 1971.4  
 15 98  
 -----  
 2 73

## Melroe Company is ISO 9001 certified





ISO 9001 is a set of international standards that control the processes and procedures which we use to design, develop, manufacture, distribute, and service Melroe Company products.

British Standards Institute (BSI) is the Certified Registrar Melroe chose to assess the Company's compliance with the ISO 9001 set of standards. The BSI registration certifies that the two Melroe manufacturing plants and the Melroe corporate offices (Gwinner, Bismarck & Fargo) in North Dakota are in compliance with ISO 9001. Only certified assessors, like BSI, can grant registrations. Since registration requires this *third-party auditing*, it is irrefutable evidence of conformance. Continued certification is subject to periodic audits.

ISO 9001 means that as a company we say what we do and do what we say. In other words, we have established procedures and policies, and we provide evidence that the procedures and policies are followed.

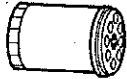
What does ISO 9001 mean to Bobcat Customers? It means that Melroe Company produces your Bobcat loader, Excavator or Spra-Coupe, and attachments with strict attention to details, using the latest technology and proven techniques.

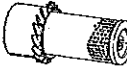
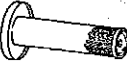
### REGULAR MAINTENANCE ITEMS

-  6659329 ENGINE OIL FILTER (12 Pack)
-  6667352 FUEL FILTER *667 777.3*
-  6646492 AIR CLEANER, OUTER
-  6598362 AIR CLEANER, INNER
- 6646678 RADIATOR CAP
- 6661248 HYDROSTATIC FILTER *\$28.69*
- 6665032 BATTERY *6630977*
- 6658-671*  *6661769* *MUFFLER* 6724094 PROPYLENE GLYCOL ANTI-FREEZE, Premixed - [-34°F (-37°C)] *\$24.76*
- 6724354 PROPYLENE GLYCOL ANTI-FREEZE, Concentrate
- 6563328 BLACK GOLD Hydraulic/Hydrostatic Fluid - 5 Gallons
- 6657299 MOTOR OIL 15W40 CE/SG - 1 Qt.
- 6657300 MOTOR OIL 15W40 CE/SG - 5 Qt.
- 6657301 MOTOR OIL 10W30 CE/SG - 1 Qt.
- 6657302 MOTOR OIL 10W30 CE/SG - 5 Qt.
- 6657303 MOTOR OIL 30 CE/SG - 1 Qt.
- 6657304 MOTOR OIL 30 CE/SG - 5 Qt.



# FOREWORD

**FOREWORD**

This Operation & Maintenance Manual was written to give the owner/operator instructions on the safe operation and maintenance of the Bobcat loader. **READ AND UNDERSTAND THIS OPERATION & MAINTENANCE MANUAL BEFORE OPERATING YOUR LOADER.** If you have any questions, see your Bobcat loader dealer.

SERIAL NUMBER LOCATIONS ..... v  
DELIVERY REPORT ..... v  
BOBCAT SKID STEER LOADER IDENTIFICATION ..... vi

\$ 745.00

Gem

Gim



## SERIAL NUMBER LOCATIONS

Always use the serial number of the loader when requesting service information or when ordering parts. Early or later models (identification made by serial number) may use different parts, or it may be necessary to use a different procedure in doing a specific service operation.

### LOADER SERIAL NUMBER

The loader serial number plate is located on the inside of the left upright, above the grill [A].

Explanation of loader Serial Number:

XXXX XXXXX

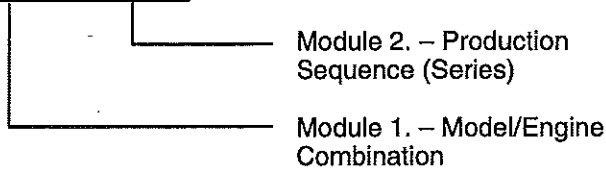

The four digit Model/Engine Combination Module number identifies the model number and engine combination.

The five digit Production Sequence Number identifies the order which the loader is produced.

### ENGINE SERIAL NUMBER

The serial number is near the fuel injection pump on the engine block [B].

### DELIVERY REPORT

The Delivery Report must be filled out by the dealer and signed by the owner or operator when the Bobcat loader is delivered. An explanation of the form must be given to the owner. Make sure it is filled out completely [C].

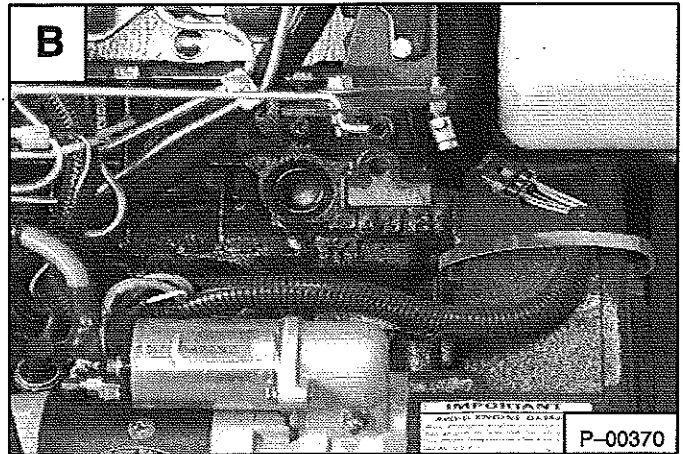
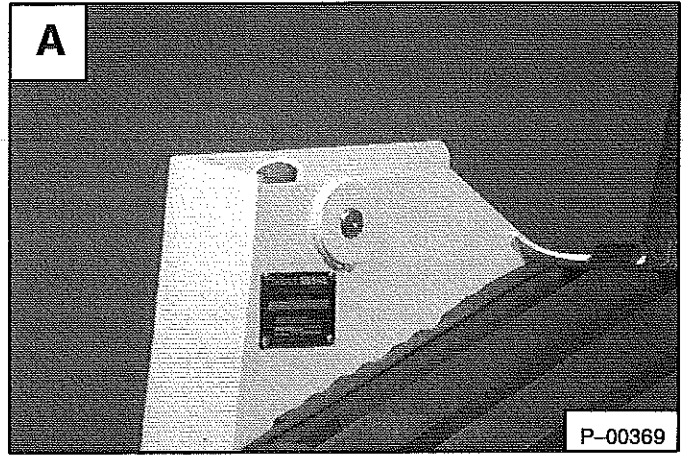
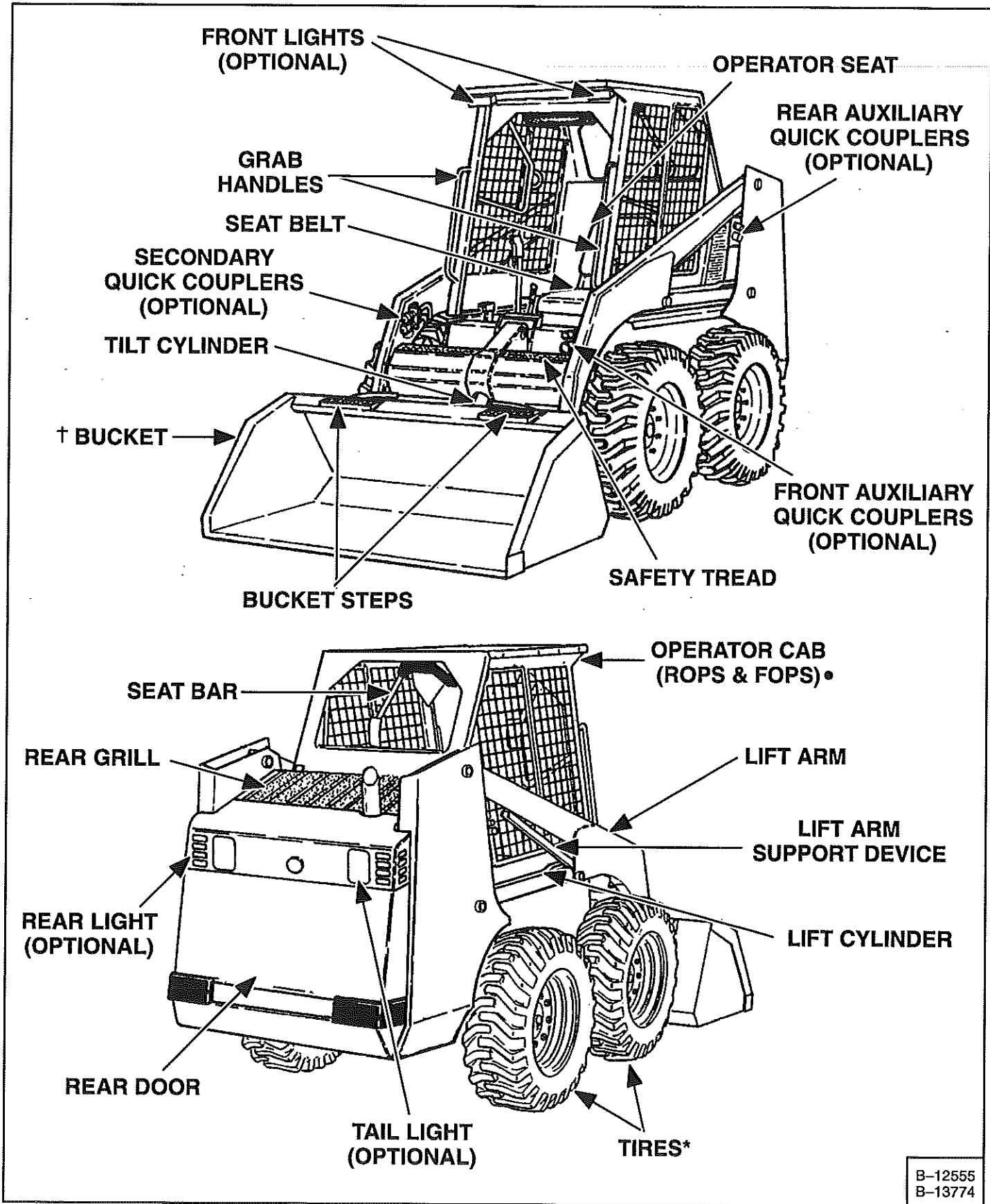

Image C shows a "DELIVERY REPORT" form. The form is divided into several sections: a "DELIVERY REPORT" header, a "WARNING" section, and several sections of horizontal lines for text entry. A small label "P-00370" is in the bottom right corner.

# BOBCAT SKID STEER LOADER IDENTIFICATION



B-12555  
B-13774

\* TIRES - Flotation tires are shown. The Bobcat loader is base-equipped with standard tires.  
 † BUCKET - Several different buckets and other attachments are available for the Bobcat loader.  
 • ROPS, FOPS - Roll Over Protective Structure, Falling Object Protective Structure, per SAE J1040 and SAE J1043. The Bobcat loader is base-equipped with a standard operator cab as shown.

# SAFETY

SAFETY INSTRUCTIONS .....	ix
FIRE PREVENTION .....	xi
MACHINE SIGNS (DECALS) .....	xii





**bobcat**<sup>®</sup>

# SAFETY INSTRUCTIONS

## SAFETY IS THE OPERATOR'S RESPONSIBILITY

The Skid Steer Loader is a highly maneuverable and compact machine. In operation, it is rugged and useful under a wide variety of conditions. This presents an operator with hazards associated with off highway, rough terrain applications. The loader has an internal combustion engine with resultant heat and exhaust. All exhaust gases can kill or cause illness so the loader must be used with adequate ventilation. The loader has a spark arrestor muffler which is required for operation in certain areas.

The dealer explains the capabilities and restrictions of the loader and attachments for each application. The dealer demonstrates the safe operation of the loader according to Melroe's instructional materials; which are also available to operators. The dealer can also identify unsafe modifications or use of unapproved attachments. The attachments and buckets are designed for rated capacity and secure fastening to the loader. The user must check with the dealer, or Melroe Company literature, to determine safe loads of materials of specified densities for his loader-attachment combination.

The following publications provide information on the safe use and maintenance of the loader and attachments:

- The Delivery Report is used to assure that complete instructions have been given to the new owner and that the machine is in safe operating condition.
- The Operation & Maintenance Manual delivered with the loader gives operating information as well as routine maintenance and service procedures. It is a part of the loader and must stay with the machine when it is sold. Replacement Operation & Maintenance Manuals can be ordered from your Bobcat loader dealer.
- The loader has machine signs (decals) which instruct on the safe operation and care. The signs and their locations are shown in the Operation & Maintenance Manual. Replacement signs are available from your Bobcat loader dealer.
- The loader has a plastic Operator's Handbook fastened to the operator cab. Its brief instructions are convenient to the operator. The handbook is available from your dealer in an English edition or one of the following languages: French, German, Italian, Dutch, & Spanish.
- The EMI Safety Manual (also available in Spanish) delivered with the loader gives general safety information.
- The Service Manual and Parts Manual are available from your dealer for use by mechanics to do shop-type service and repair work.
- The Skid Steer Loader Operator Training Course is available through your local dealer. This course is intended to provide rules and practices for correct operation of the Bobcat loader. The course is available in English and Spanish versions.
- The Bobcat Skid Steer Loader Safety Video is available from your Bobcat Dealer.

The dealer and owner/operator review the recommended uses of the loader and attachments when the loader is delivered. If the owner/operator will be using the loader for a different application(s) he must ask the dealer for recommendations on the new use.



## BEFORE OPERATING THE BOBCAT LOADER



**Safety Alert Symbol:** This Safety Symbol is used for important safety messages. When you see this symbol follow safety message to avoid personal injury or death.

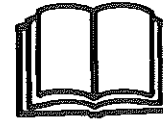

B-10731

The Bobcat loader must be in good operating condition before use.

Check all of the items on the Service Schedule Decal or as shown in this Operation & Maintenance Manual under **Daily Inspection**.

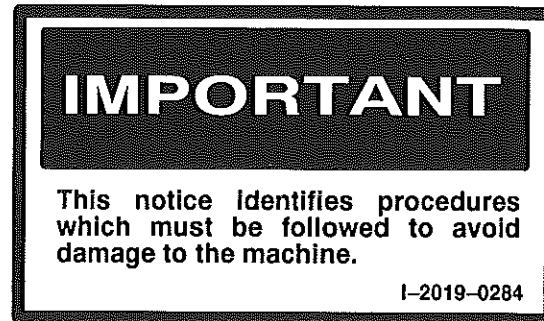
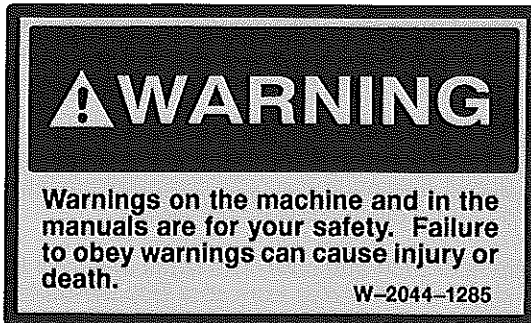

## SAFE OPERATION NEEDS A QUALIFIED OPERATOR\*

### A QUALIFIED OPERATOR MUST DO THE FOLLOWING:

- UNDERSTAND THE WRITTEN INSTRUCTIONS, RULES AND REGULATIONS
  - The written instructions from Melroe Company include the delivery report, Operation & Maintenance Manual and plastic handbook, EMI Safety Manual and machine signs (decals).
  - Check the rules and regulations at your location. The rules may include an employer's work safety requirements. Regulations may identify a hazard such as a utility supply line.
- HAVE TRAINING WITH ACTUAL OPERATION
  - Operator training must consist of a demonstration and verbal instruction. This training is given by your dealer before the loader is delivered.
  - The new operator must start in an area without bystanders and use all the controls until he can operate the loader safely under all conditions of the work area. Always fasten seat belt and lower seat bar before operating.
- KNOW THE WORK CONDITIONS
  - For each material to be handled, the operator must know how to avoid exceeding the rated operating capacity of the loader. For example, in handling certain loose material with a given bucket, he must know whether he can safely take a full load, or only part of a bucket load.
  - The operator must know any prohibited uses or work areas, for example, he needs to know about excessive slopes.
  - Wear tight fitting clothing. Always wear safety glasses when maintaining or servicing loader. Safety glasses, hearing protection or loader special applications kit are required for some work. See your dealer about Melroe Safety equipment.

\* For an operator be qualified, he must not use drugs or alcoholic drinks which impair his alertness or coordination while working. An operator who is taking prescription drugs must get medical advice to determine if he can safely operate a machine.

## FIRE PREVENTION

The loader has several components that are at high temperature under normal operating conditions. The primary source of high temperatures is the engine and exhaust system. The electrical system, if damaged or incorrectly maintained, can be a source of arcs or sparks.

Flammable debris (leaves, straw, etc.) must be removed regularly. If flammable debris is allowed to accumulate, it will increase the fire hazard. The loader must be cleaned as often as necessary to avoid this accumulation. Flammable debris in the engine compartment is a fire hazard when the loader is parked with a hot engine.

The exhaust system is designed to control the emission of hot particles from the engine and exhaust system, but the muffler and the exhaust gases are still hot.

- Know where fire extinguishers and first aid kits are located and how to use them.
- Do not use the Bobcat loader where exhaust, arcs, sparks or hot components can contact flammable material, explosive dust or gases.
- The engine compartment and engine cooling system must be inspected every day and cleaned if necessary to prevent fire hazard and overheating.
- Check all electrical wiring and connections for damage. Keep the battery terminals clean and tight. Repair or replace any damaged part.
- Check fuel and hydraulic tubes, hoses and fittings for damage and leakage. Never use open flame or bare skin to check for leaks. Tighten or replace any parts that show leakage. Always clean fluid spills. Do not use gasoline or diesel fuel for cleaning parts. Use commercial nonflammable solvents.
- Do not use ether or starting fluids on this engine. It has glow plugs. These starting aids can cause explosion and injure you or bystanders.
- Always clean the loader and disconnect the battery before doing any welding. Cover rubber hoses, battery and all other flammable parts. Keep a fire extinguisher near the loader when welding. Have good ventilation when grinding or welding painted parts. Wear dust mask when grinding painted parts. Toxic dust or gas can be produced.
- Stop the engine and let it cool before adding fuel. No smoking!
- Use the procedure in the Operation & Maintenance Manual for connecting the battery.
- Use the procedure in the Operation & Maintenance Manual for cleaning the spark arrestor muffler.

A fire extinguisher is available from your Bobcat dealer. The fire extinguisher can be installed in the location shown [A].

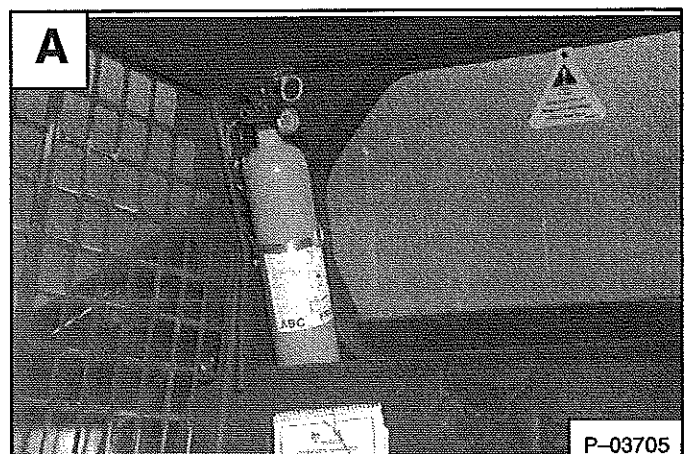

# MACHINE SIGNS (DECALS)

Follow the instructions on all the Machine Signs (Decals) that are on the loader. Replace any damaged machine signs and be sure they are in the correct locations. Machine signs are available from your Bobcat dealer.

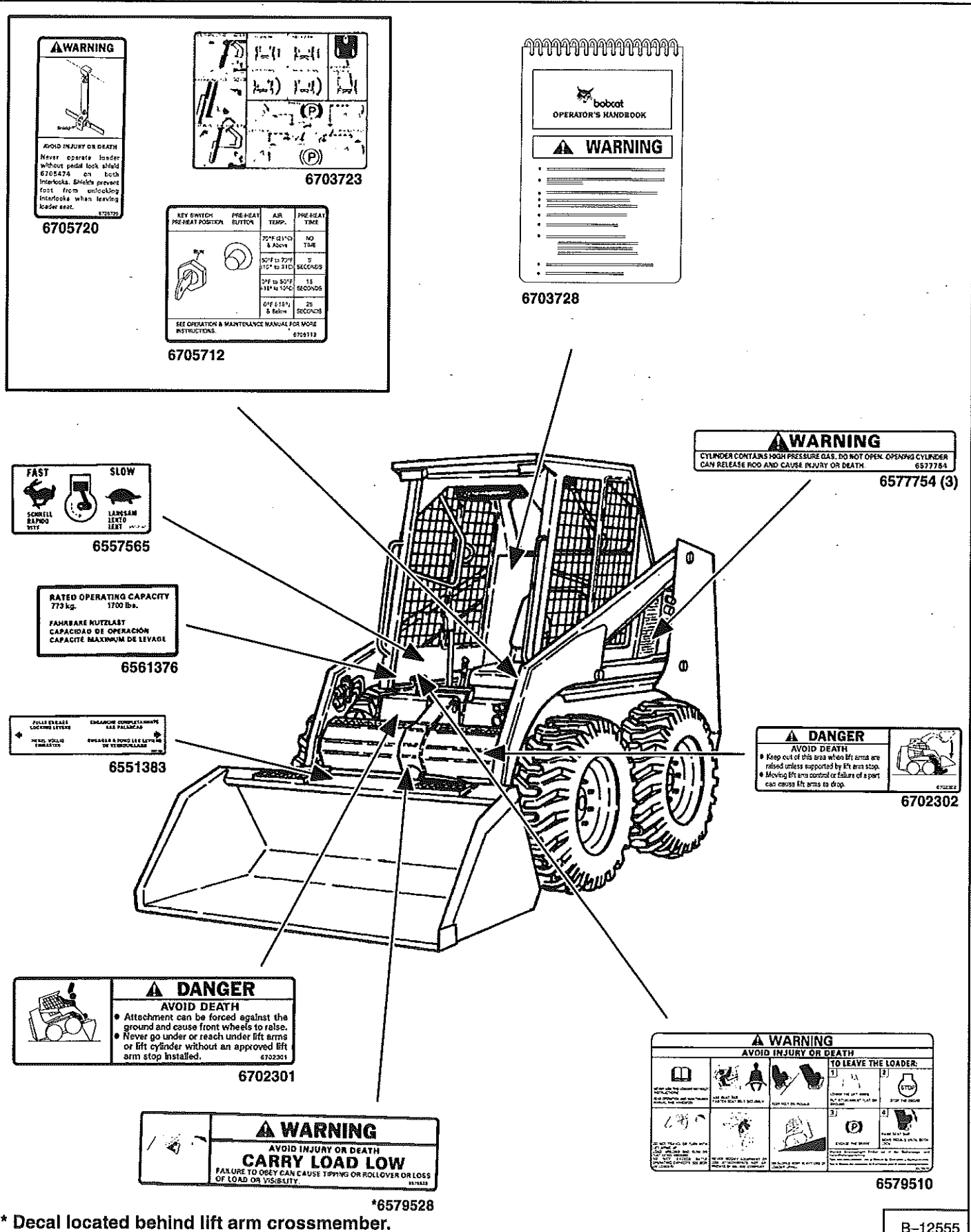

**WARNING**

**AVOID INJURY OR DEATH**  
 Never operate loader without pedal lock shield 6705474 on both interlocks. Shields prevent foot from unlocking interlocks when leaving loader seat.

6705720

6703723

KEY SWITCH PRE-HEAT POSITION	PRE-HEAT SWITCH	AIR TEMP.	PRE-HEAT TIME
OFF (15°) & Above	ON	NO TIME	
OFF to 50°F (10° to 10°C)	ON	5 SECONDS	
OFF to 50°F (10° to 10°C)	OFF	15 SECONDS	
OFF (15°) & Below	ON	25 SECONDS	

SEE OPERATION & MAINTENANCE MANUAL FOR MORE INSTRUCTIONS. 6705712

bobcat  
OPERATOR'S HANDBOOK

**WARNING**

6703728

**FAST SLOW**

SONELL RAPIDO LENTO

6557565

**RATED OPERATING CAPACITY**  
 770 kg. 1700 lbs.

FAHRGEBE NUTZLAST  
 CAPACIDAD DE OPERACIÓN  
 CAPACITÉ MAXIMUM DE LEVAGE

6561376

FOUR RELEASE LOCKING LEVERS ENGAGNE COMPLETEMENT LES PALANQUES

← PULL, HOLD, ENGAGE → EMPUJA Y MANTÉN LAS LEVAS DE ENCLAVAMIENTO

6551383

**WARNING**

CYLINDER CONTAINS HIGH PRESSURE GAS. DO NOT OPEN. OPENING CYLINDER CAN RELEASE FROD AND CAUSE INJURY OR DEATH.

6577754

6577754 (3)

**⚠ DANGER**

**AVOID DEATH**

- Keep out of this area when lift arms are raised unless supported by lift arm stop.
- Moving lift arm control or failure of a part can cause lift arms to drop.

6702302

**⚠ DANGER**

**AVOID DEATH**

- Attachment can be forced against the ground and cause front wheels to raise.
- Never go under or reach under lift arms or lift cylinder without an approved lift arm stop installed.

6702301

6702301

**⚠ WARNING**

**AVOID INJURY OR DEATH**

**CARRY LOAD LOW**

FAILURE TO OBEY CAN CAUSE TIPPING OR ROLLOVER OR LOSS OF LOAD OR VISIBILITY.

6579528

\*6579528

\* Decal located behind lift arm crossmember.

**⚠ WARNING**

**AVOID INJURY OR DEATH**

**TO LEAVE THE LOADER:**

1. Lower the lift arms.
2. Turn the lift arm control to the stop position.
3. Turn the key to the "OFF" position.
4. Turn the parking brake on.

6579510

6579510

B-12555





# OPERATING INSTRUCTIONS

ATTACHMENTS & BUCKETS .....	20
Installation And Removal .....	21
DAILY INSPECTION .....	12
ENGINE SPEED CONTROL .....	5
GETTING READY FOR OPERATION .....	14
HYDRAULIC CONTROLS .....	7
Auxiliary Hydraulics Operation (Optional) .....	8
Auxiliary Hydraulics Operation (With Optional BOSS®) .....	9
Auxiliary Hydraulics Operation 853H (Optional) .....	10
Bucket Position Valve Operation .....	7
Foot Pedals .....	7
Lift Arm Operation .....	7
Tilt Operation (Bucket) .....	7
INSTRUMENT PANEL .....	3
Standard .....	3
Optional BOSS® .....	4
LIFTING THE LOADER .....	26
Four Point Lift .....	26
Single Point Lift .....	26
OPERATING PROCEDURES .....	22
Backfilling .....	25
Emptying The Bucket .....	23
Digging Into The Ground .....	24
Filling The Bucket .....	23
Leveling The Ground (Using Lift Arms In Float Position) .....	24
PARKING BRAKE .....	5
PARKING THE BOBCAT LOADER .....	25
SEAT BAR RESTRAINT SYSTEM .....	13
STARTING THE ENGINE .....	15
Cold Temperature Starting Condition (Optional) .....	19
Cold Temperature Starting Condition (Standard) .....	16
Normal Starting Condition (Optional) .....	18
Normal Starting Condition (Standard) .....	16
Warming The Hydraulic/Hydrostatic System .....	17
STEERING LEVERS .....	6
Forward Travel .....	6
Reverse Travel .....	6
Normal Turning .....	6
Fast Turning .....	6
STOPPING THE ENGINE .....	19
TRANSPORTING THE BOBCAT LOADER .....	25

**OPERATING  
INSTRUCTIONS**





## INSTRUMENT PANEL (Cont'd)

### Standard

The instrument panel has the following instruments [A]:

1. **LIGHT SWITCH (OPT.)** – Controls the work and travel lights.
2. **KEY SWITCH** – For starting, stopping and *preheating* the engine.
3. **FUSE (ACCESSORIES)** – To protect the electrical system from overload.
4. **FUSE (IGNITION)** – To protect the electrical system from overload.
5. **HOURLMETER** – Records the total operating hours of the loader.
6. **FUEL GAUGE** – Shows the amount of fuel in the fuel tank.
7. **ENGINE TEMPERATURE GAUGE** – Shows the engine coolant temperature.
8. **ENGINE WARNING LIGHT** – Engine oil pressure is low. Stop the engine if the light comes ON.
9. **TRANSMISSION WARNING LIGHT** – Low transmission charge pressure, hydraulic filter needs replacement or high fluid temperature. Stop the engine if the light comes ON.
10. **VOLTMETER** – Shows the condition of the battery and the rate of charge.
11. **PREHEAT BUTTON** – For preheating the glow plugs before starting the engine.
12. **AUXILIARY HYDRAULICS MODE SWITCH (OPT.)** – For engaging the auxiliary hydraulics (front & rear).

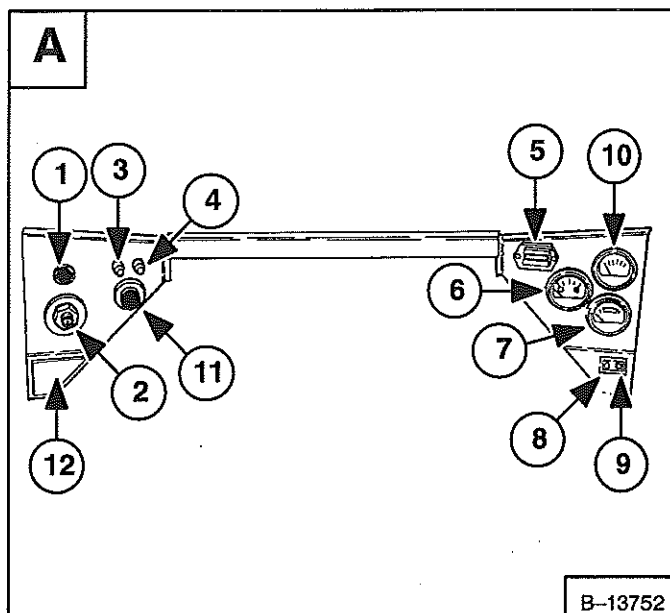

## INSTRUMENT PANEL

### Optional BOSS®

The following items are located on the instrument panel [A] & [B]:

1. **IGNITION SWITCH** – Controls the starting and stopping of the engine. If engine doesn't start turn the key to the OFF position for 3 seconds to reset the fuel timer module.
2. **LIGHT SWITCH (OPTIONAL)** – Controls the work and travel lights.
3. **DIAGNOSTIC COUPLER** – Connector for diagnostic tool to make service checks of the system operation unit and other components.
4. **DISPLAY PANEL** – The display has the following symbols and functions (Ref. 5 thru 18).
5. **OPTIONAL AUXILIARY HYDRAULICS MODE SWITCH** – For Engaging The Auxilliary Hydraulics (Front And Rear).
6. **FUEL** – Shows the amount of fuel in the tank.
7. **BATTERY VOLTAGE** – Shows the condition of the battery and charge rate. Also will indicate a WARNING for high and low voltage.
8. **ENGINE OIL SYMBOL** – Shows engine oil pressure. Flashing symbol indicated low oil pressure.
9. **ENGINE COOLANT SYMBOL** – Shows engine coolant temperature and/or low coolant level (SHUTDOWN).
10. **FUEL FILTER** – If fuel pump and bar flashes it is a low fuel WARNING H<sub>2</sub>O symbol indicates water in the fuel filter (NOT FUNCTIONAL AT THIS TIME).
11. **SHUTDOWN SYMBOL** – The symbol is associated with any shutdown condition. When this symbol comes ON the shutdown will occur in 30 seconds. During shutdown the buzzer will sound continuously and the symbol will flash until the key is turned OFF.

**NOTE:** The engine can be restarted for 30-second periods to move the loader after a shutdown condition.

12. **WARNING SYMBOL** – The symbol will be ON when any warning or shutdown is activated. The warning symbol is also used to indicate a warning if there is no related symbol on the display. During a warning the buzzer will beep three times and symbol will be on continuously.
13. **HOURMETER** – Records the total operating hours of the loader. The five character code will display the operating hours to the nearest tenth. When SHUTDOWNS or WARNINGS occur an alpha-numeric code will be displayed in the hourmeter area to inform the operator of the problem (See Page 59 for code listing). During a SHUTDOWN or WARNING the hourmeter symbol is not visible.
14. **CHARGE PRESSURE AND FILTER CONDITION** – Flashing symbol indicates low fluid charge pressure and SHUTDOWN. If arrows are ON with gear/drop it is fluid charge pressure. This symbol will also indicate a clogged hydraulic fluid filter.

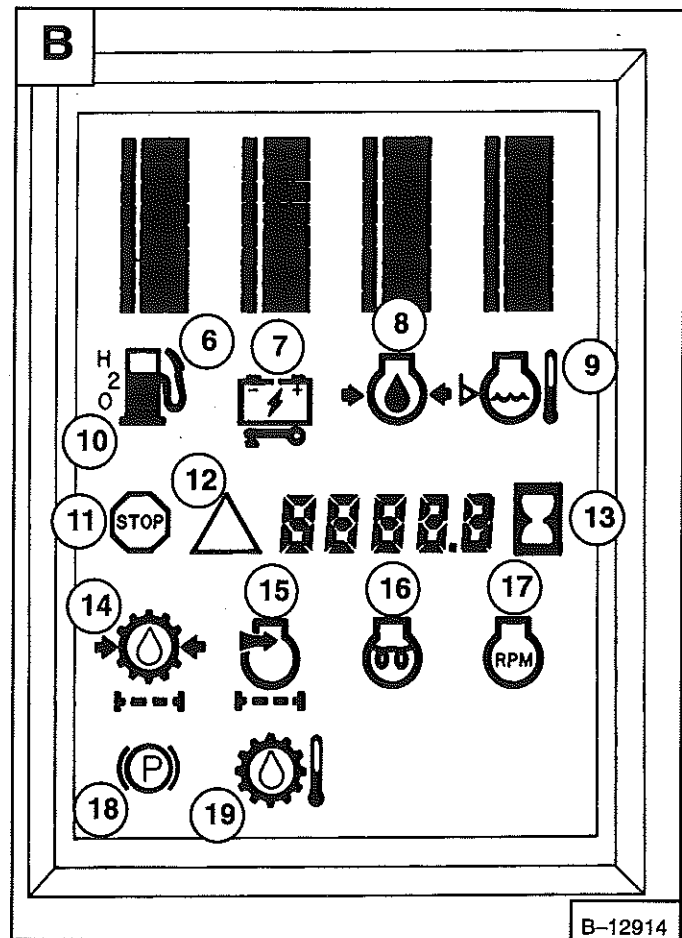
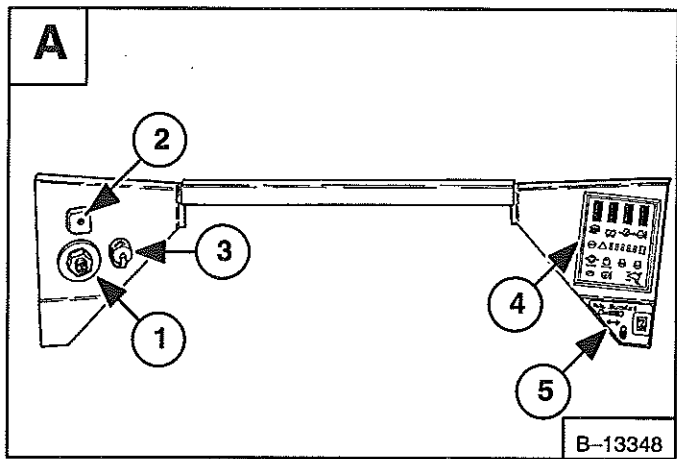

15. **AIR FILTER CONDITION** – This symbol will indicate a clogged air filter element.
16. **GLOW PLUG** – The symbol will flash when the glow plugs are energized. The hourmeter will also contain characters GLOXX where XX indicates the remaining time the glow plugs will be ON. Glow plug will count down in 5 second increments.
17. **ENGINE SPEED** – This symbol will indicate an engine overspeed WARNING and SHUTDOWN.
18. **PARKING BRAKE** – This symbol will indicate when the brake is engaged (NOT FUNCTIONAL AT THIS TIME).
19. **HYDRAULIC FLUID TEMPERATURE** – This symbol will indicate a high fluid temperature and SHUTDOWN or WARNING.

## ENGINE SPEED CONTROL

The engine speed control (Item 1) [A] is at the right side of the operator's seat. Engine speed is controlled by moving the speed control forward to increase the engine RPM and backward to decrease the engine RPM.

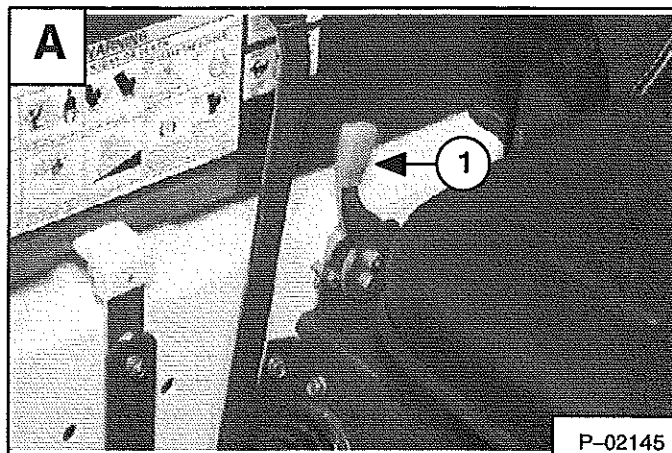

## PARKING BRAKE

Lock the parking brake by pushing down on the top (toe) of the pedal [B].

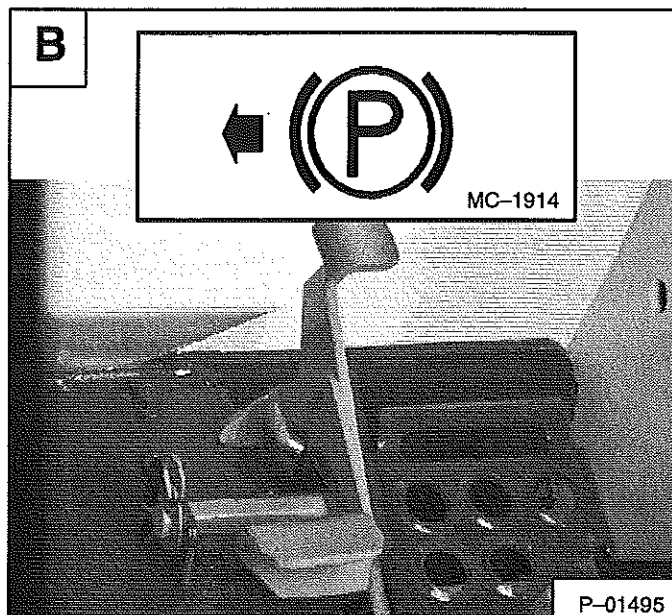

To release the parking brake, push down on the bottom (heel) of the pedal [C].

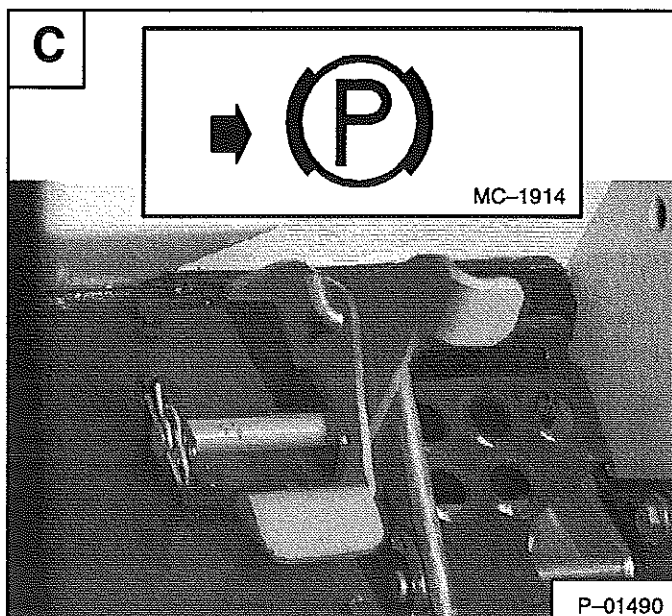

## STEERING LEVERS



# WARNING

### AVOID INJURY OR DEATH

When operating the machine:

- Keep the seat belt fastened snugly.
- The seat bar must be lowered.
- Keep your feet on the pedal controls.

W-2046-0595

The steering lever (Item 1) [A] are on the right and left side in front of the seat.

For safe control of the loader always move the levers slowly and smoothly. Only a small movement is necessary to move the loader.

The steering levers control forward and reverse travel of the loader [B].

**Forward Travel** – Push both levers forward.

**Reverse Travel** – Pull both levers backward.

**Normal Turning** – Move one lever farther forward than the other.

**Fast Turning** – Push one lever forward and pull the other lever backward.

For slow travel speed, push the steering levers forward only a small amount.

To increase travel speed, push both levers farther forward.

For maximum pushing force, push the levers forward only a small amount with the engine at full RPM.

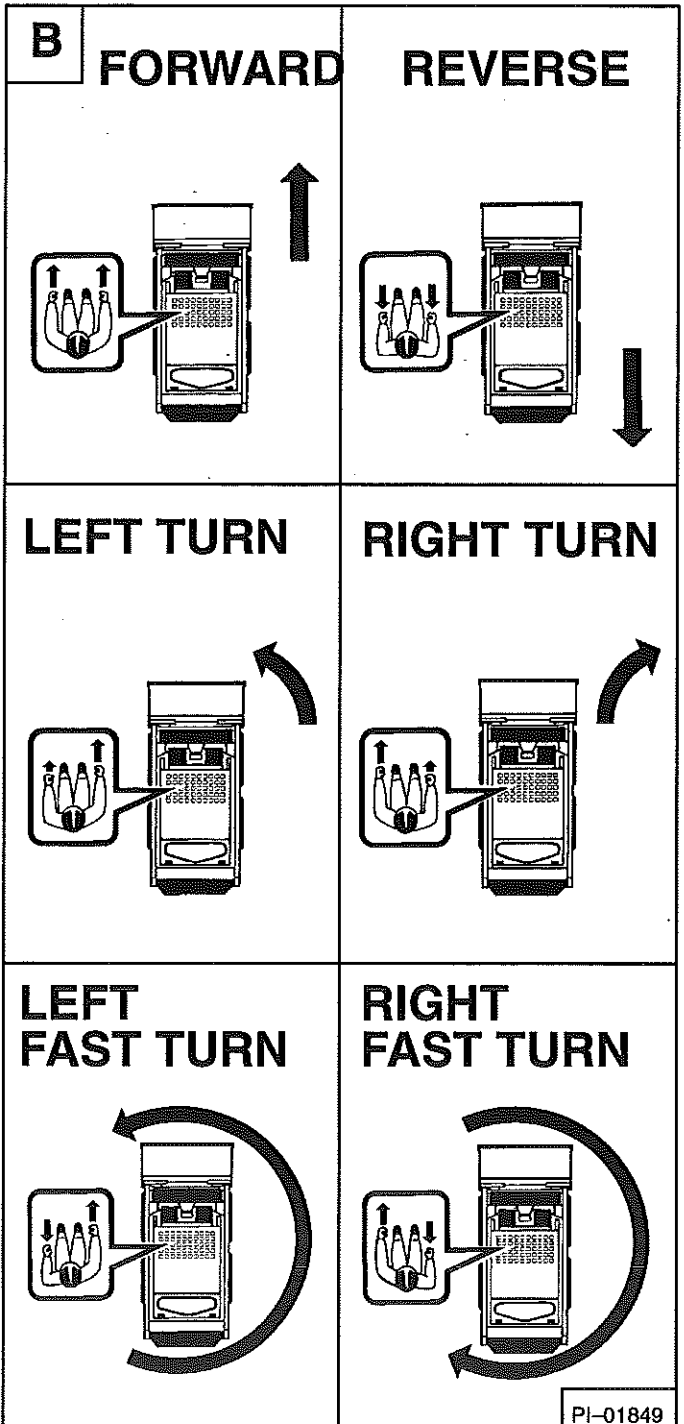
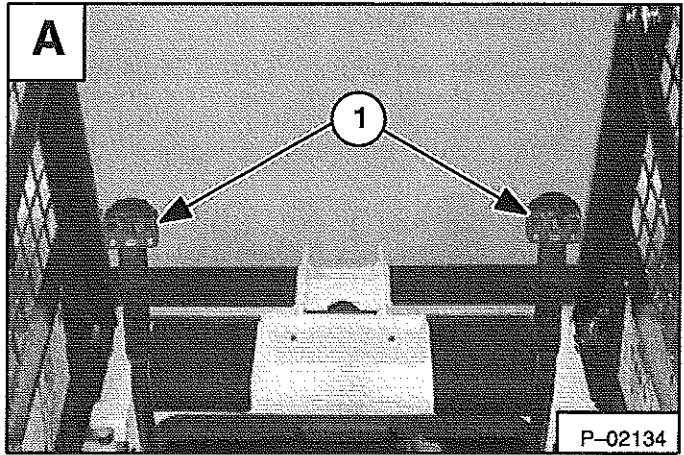

## HYDRAULIC CONTROLS

### Foot Pedals



## WARNING

Keep both feet on pedals while operating machine. Failure to do so can cause serious injury.

W-2002-1285

## IMPORTANT

Clean dirt and debris from the foot pedals and surrounding area before operating the loader, to ensure proper operation of the foot pedals.

I-2105-0196

Put your feet on the pedals and **KEEP THEM THERE** any time you operate the loader.

Two foot pedals (Item 1) [A] control the hydraulic cylinders for the lift and tilt function.

### Lift Arm Operation

The left pedal controls the lift arms. Push on the bottom (heel) (Item 2) [A] of the pedal to raise the lift arms.

Push on the top (toe) (Item 3) [A] of the pedal to lower the lift arms.

Push the top (toe) (Item 3) [A] of the lift pedal all the way forward until it locks into *detent* (float). Use the *float* position of the lift arms to level loose material while driving backward.

### Tilt Operation (Bucket)

The right pedal controls the action of the bucket. Push the top (toe) (Item 4) [A] of the pedal to tilt the bucket forward.

Push the bottom of the pedal (heel) (Item 5) [A] to tilt the bucket backward.

### Bucket Position Valve Operation (Optional)

The function of the bucket positioning valve is to keep the bucket in the same approximate position it is placed in, prior to the upward lift cycle.

Bucket positioning functions automatically during the upward lift cycle only.

A

1

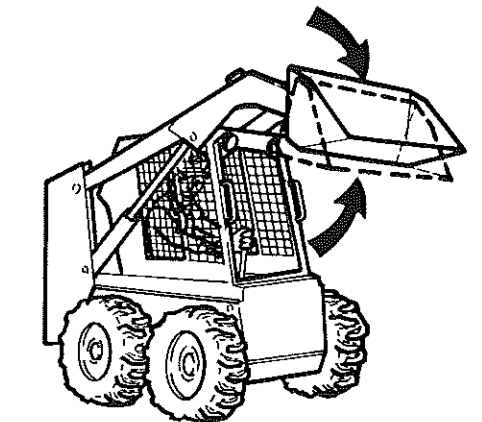
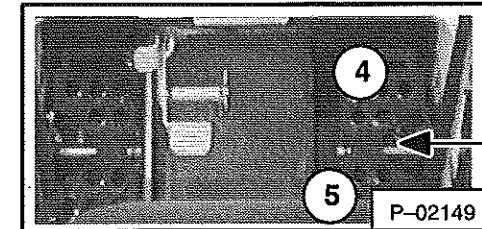
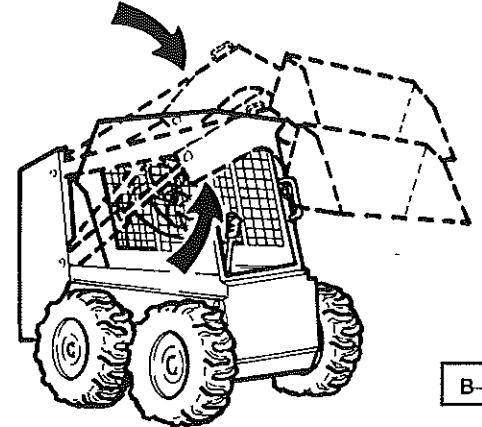
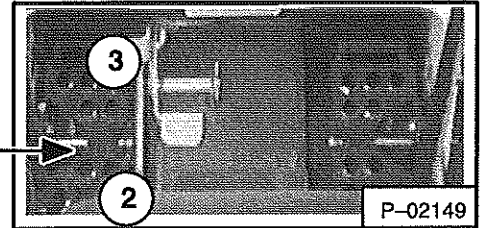

## HYDRAULIC CONTROLS (Cont'd)

### Auxiliary Hydraulics Operation (Optional)

Described below is the operation of the optional auxiliary hydraulics used with the standard instrument panel.

**NOTE: The right and left steering lever control are blank (no switches) as standard.**

Press the mode switch (Item 1) [A] (on the instrument panel) to allow for the front and rear auxiliary hydraulics, the light (Item 2) [A] will come ON.

The switch (Item 1) [B] on the right steering lever controls the front auxiliary hydraulics and the switch (Item 2) [B] on the left steering lever control the rear auxiliary hydraulics.

Switch (Item 4) [B] controls the optional horn.

#### (OPTIONAL) FRONT AUXILIARY CONTROL:

Push switch (Item 1) [B] in the right or left direction (with mode switch engaged & top light ON to change fluid flow direction to the front quick couplers [C]. (Example: Open and close grapple teeth.)

#### (OPTIONAL) REAR AUXILIARY CONTROL:

Push the switch (Item 2) [B] in the right or left direction (with mode switch engaged & top light ON to change the fluid flow direction to the rear quick couplers [C]. (Example: Raise or lower rear stabilizers.)

#### DETENT CONTROL:

Push the mode switch (Item 1) [A] the second time to engage the *detent* function and both lights (Items 2 & 3) [A] will come ON. Push the front button (Item 3) [B] to give the front auxiliary hydraulics a constant flow of fluid. (Example: Operate a backhoe.)

To release the *detent* position, push the switch (Item 3) [B] again.

#### RELIEVE PRESSURE AT FRONT QUICK COUPLERS:

Turn the key switch to the OFF position, as the engine stops running, turn the key switch all the way to the left (hold the key in this position & until the engine stops) to release the hydraulic pressure at the front quick couplers.

#### RELIEVE PRESSURE AT REAR QUICK COUPLERS:

With the engine running, press the mode switch (Item 1) [A] to engage the auxiliary hydraulics, the light (Item 2) [A] will come ON.

Push the heel of the tilt pedal so the hydraulic fluid goes over the main relief pressure and at the same time push switch (Item 2) [B] back and forth several times to relieve the pressure at the rear quick couplers. Release the tilt pedals. Stop the engine.

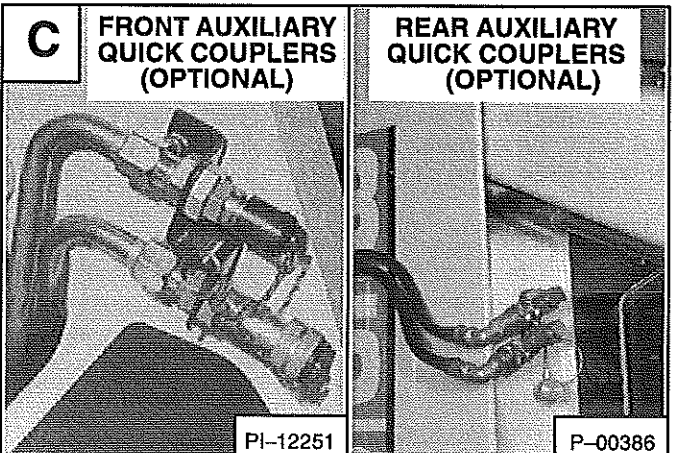
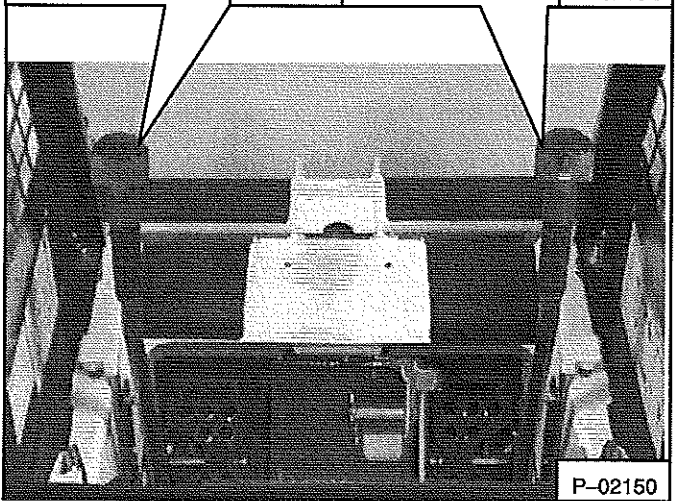
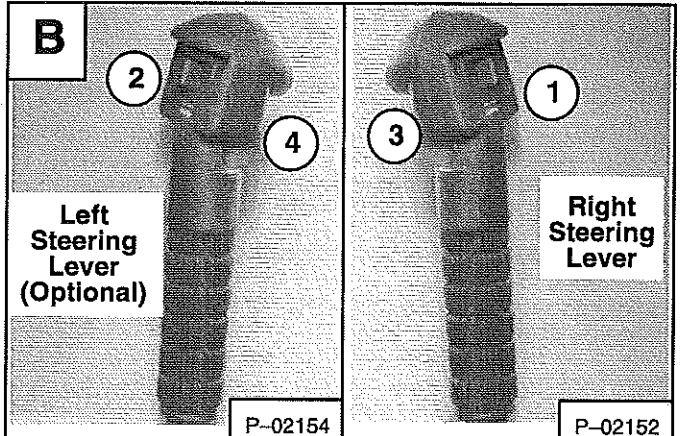
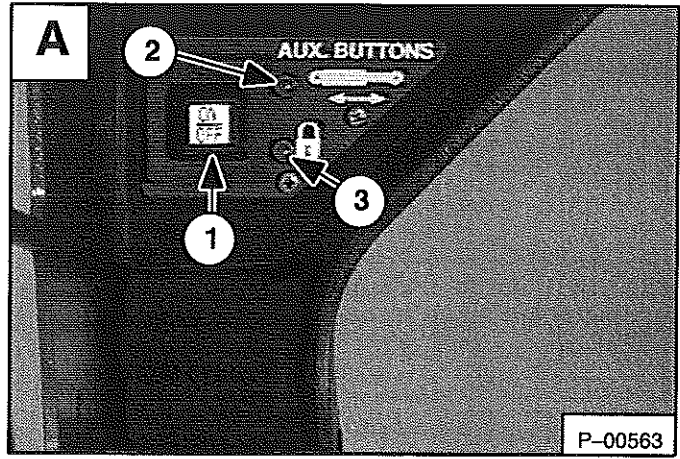



## HYDRAULIC CONTROLS (Cont'd)

### Auxiliary Hydraulics Operation (With Optional BOSS®)

Described below is the operation of the optional auxiliary hydraulics used with the standard instrument panel.

**NOTE: The right and left steering lever control are blank (no switches) as standard.**

Press the mode switch (Item 1) [A] (on the instrument panel) to allow for the front and rear auxiliary hydraulics, the light (Item 2) [A] will come ON.

The switch (Item 1) [B] on the right steering lever controls the front auxiliary hydraulics and the switch (Item 2) [B] on the left steering lever control the rear auxiliary hydraulics.

Switch (Item 4) [B] controls the optional horn.

#### (OPTIONAL) FRONT AUXILIARY CONTROL:

Push switch (Item 1) [B] in the right or left direction (with mode switch engaged & top light ON to change fluid flow direction to the front quick couplers [C]. (Example: Open and close grapple teeth.)

#### (OPTIONAL) REAR AUXILIARY CONTROL:

Push the switch (Item 2) [B] in the right or left direction (with mode switch engaged & top light ON to change the fluid flow direction to the rear quick couplers [C]. (Example: Raise or lower rear stabilizers.)

#### DETENT CONTROL:

Push the mode switch (Item 1) [A] the second time to engage the *detent* function and both lights (Items 2 & 3) [A] will come ON. Push the front button (Item 3) [B] to give the front auxiliary hydraulics a constant flow of fluid. (Example: Operate a backhoe.)

To release the *detent* position, push the switch (Item 3) [B] again.

#### RELIEVE PRESSURE AT FRONT QUICK COUPLERS:

Turn the key switch to the OFF position, as the engine stops running, turn the key switch all the way to the left (hold the key in this position until the engine stops) to release the hydraulic pressure at the front quick couplers.

#### RELIEVE PRESSURE AT REAR QUICK COUPLERS:

With the engine running, press the mode switch (Item 1) [A] to engage the auxiliary hydraulics, the light (Item 2) [A] will come ON.

Push the heel of the tilt pedal so the hydraulic fluid goes over the main relief pressure and at the same time push switch (Item 2) [B] back and forth several times to relieve the pressure at the rear quick couplers. Release the tilt pedals. Stop the engine.

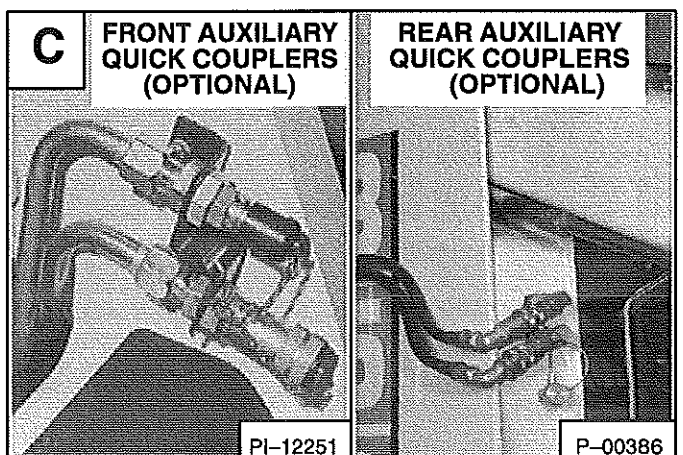
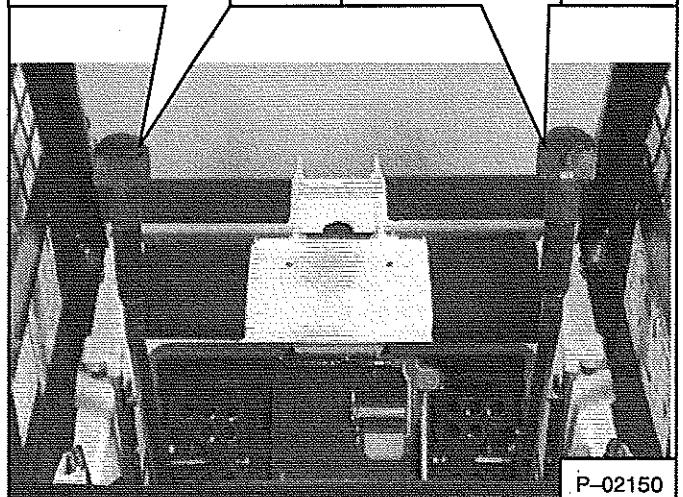
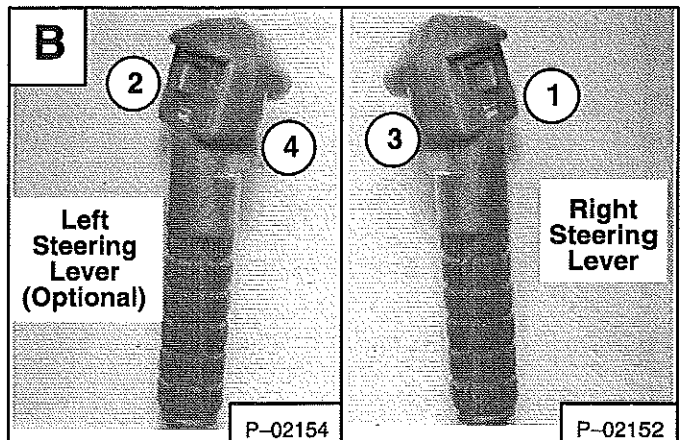
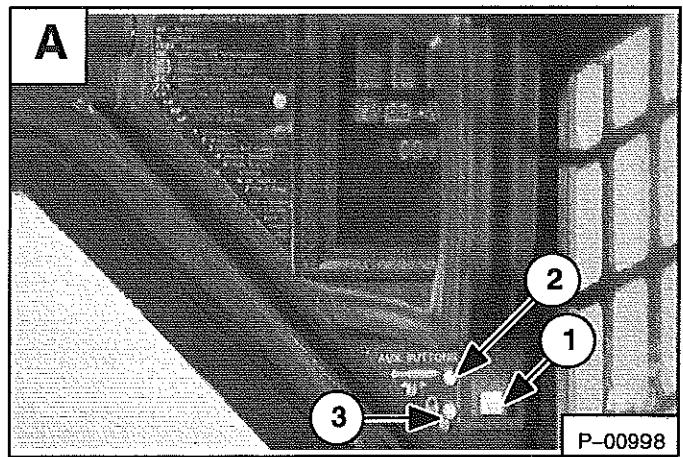



## HYDRAULIC CONTROLS (Cont'd)

### Auxiliary Hydraulics Operation – 853H (Optional)

Press the mode switch (Item 1) [A] (on the instrument panel) once to engage the auxiliary hydraulics, for *momentary operation*. The light (Item 2) [A] will come ON. Press the mode switch a second time for *continuous operation*. Both lights (Items 2 & 3) [A] will come ON. Pressing the mode switch a third time will disengage the auxiliary hydraulics and both lights will be OFF.

The buttons (switches) (Item 1 through Item 5) [B] on the right and left steering levers control the front and rear auxiliary hydraulics.

Button (Item 6) [B] controls the optional water kit. Button (Item 7) [B] controls the optional horn. Button (Item 8) [B] controls the optional left/right turn signals.

### FRONT AUXILIARY CONTROL (Momentary) (Normal Flow):

Push buttons in the right or left direction (Item 1) [B] (with mode switch engaged) for momentary or continuous operation to change fluid flow direction to the front quick couplers (Item 1) [C]. (Example: Open and close grapple teeth.)

### FRONT AUXILIARY CONTROL (Continuous) (Detent) (Normal Flow):

Push the front button (Item 2) [B] one (with mode switch engaged for continuous operation) for continuous flow to the front auxiliary quick couplers (Item 1) [C]. (Example: backhoe). To disengage continuous (detent) flow, push button (Item 2) [B] a second time.

## IMPORTANT

If the high horsepower switch is in the ON position, (See Auxiliary High Horsepower Hydraulics Operation, Page 10). High Horsepower Hydraulics will flow through the front auxiliary quick coupler (Item 1) [C]. Damage to unapproved attachments can result.

I-2106-0196

### SECONDARY AUXILIARY (Optional) (Momentary Only):

There is also a set of couplers (Item 2) [C] on the right front of the loader. These couplers are used when there is an additional connection needed for attachment operation (Example: Side shift on the planer).

Push button (Item 3) [B] in the right or left direction (with mode switch engaged) for momentary operation, to change the fluid flow direction to the secondary auxiliary couplers (Item 2) [C]. (Example: side shift on the Planer.)

Push the top or bottom of either button (Item 4 or Item 5) [B] (with mode switch engaged for momentary or continuous operation) to change fluid flow direction to the attachments.

**NOTE:** When the loader is equipped with the second and rear auxiliary hydraulics, disconnect the rear auxiliary couplers so both front and rear do not function at the same time.

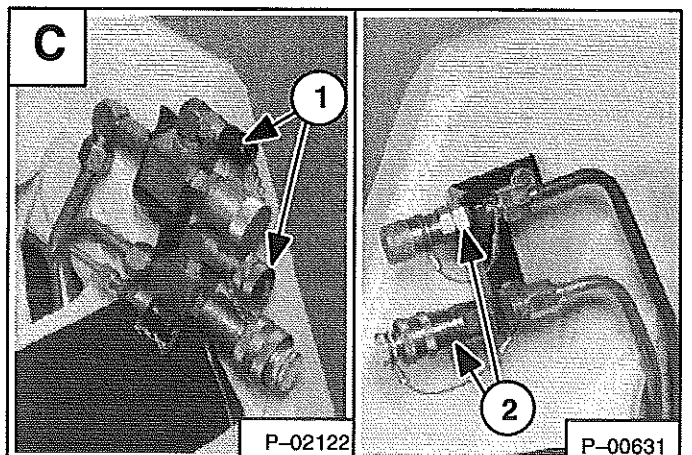
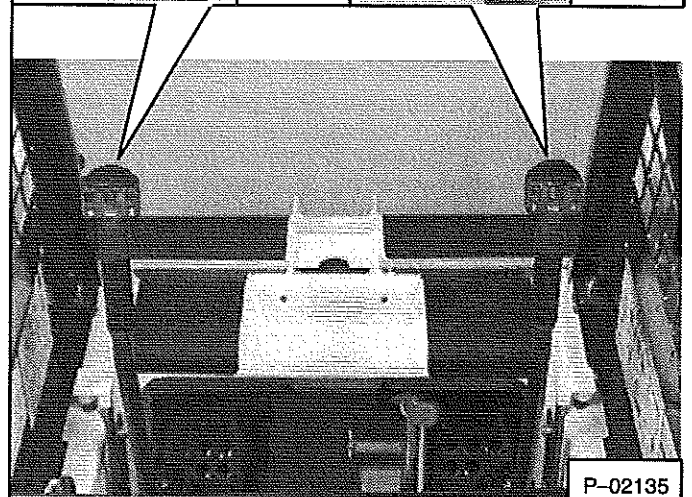
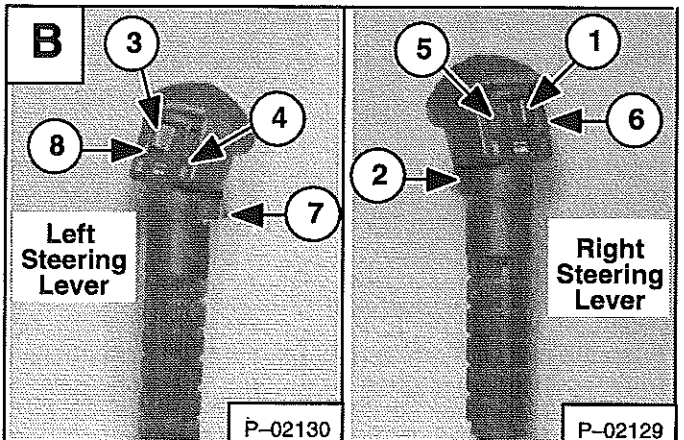
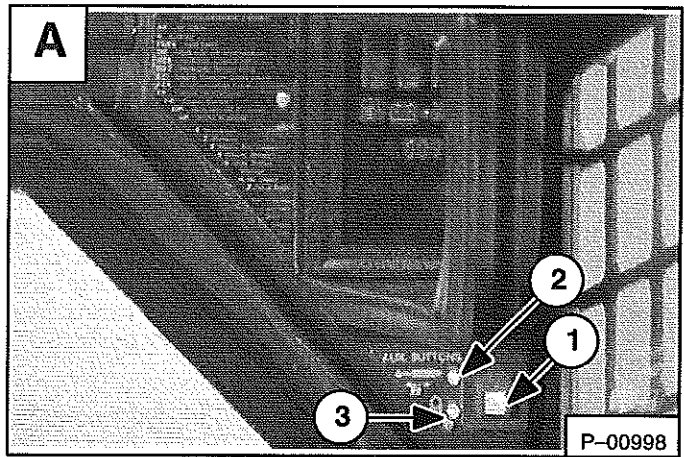

## HYDRAULIC CONTROLS (Cont'd)

### Auxiliary Hydraulics Operation – 853H (Optional) (Cont'd)

#### REAR AUXILIARY CONTROL (OPTIONAL);

Engage the mode switch for momentary operation (one light). Push button (Item 3) [B] Page 9 right or left to change the fluid flow direction to the rear quick couplers (Item 1) [A]. (Example: Raise and lower the rear stabilizers.)

**NOTE: When the loader is equipped with rear and second auxiliaries, disconnect the second auxiliary couplers so both auxiliaries do not function at the same time.**

#### RELIEVE PRESSURE AT OPTIONAL REAR COUPLERS

With the engine OFF, use a rag to cover the quick couplers and top tap the poppet with a wooden dowel. This will release trapped pressure in the hydraulic circuit.

#### RELIEVE PRESSURE AT FRONT COUPLERS

With the engine running, turn Ignition switch quickly to the left (counterclockwise) past the OFF position and hold until engine comes to a complete stop. This relieves pressure that may be trapped in the front auxiliary circuit which would hinder the engagement of attachment couplers.

#### AUXILIARY HIGH HORSEPOWER HYDRAULICS OPERATION:

The ON/OFF toggle switch (Item 1) [B] located on the left side of the operator's seat controls the *High Horsepower* function.

The *High Horsepower* function provides additional GPM to the system to operate a *High Horsepower* attachment (Example: Planer). There is a total of 24 GPM available to operate the attachment. System pressure is also increased from 2300 PSI to 3300 PSI while the *High Horsepower* function is in use.

**NOTE: Use only the large quick couplers for the *High Horsepower* function.**

With the toggle switch in the OFF position, connect the attachment quick couplers to the large quick couplers (Item 1) [C] on the left front of the loader. The *High Horsepower* attachment may have a case drain which needs to be connected to the screw on male coupler (Item 2) [C] on the left front of the loader.

When all the couplers are connected turn the toggle switch to the ON position. For continuous high pressure/high flow in forward direction push the *Detent* button (Item 2) [B] Page 9 on the front side of the right steering lever (the mode switch must be in the *continuous flow* mode). (See Page 10.) To stop continuous flow push the *Detent* button a second time.

Momentary operation of the front auxiliary is also possible with the toggle switch in the ON position (the mode switch must be either in the *Momentary* or in the *Continuous* mode). Momentary forward flow (high flow and high pressure) results from pushing the button (Item 1) [B] Page 9 to the right (Example: closing a LaBounty Shear). Momentary reverse flow (high pressure and normal flow) results from pushing the button (Item 1) [B] Page 9 to the left (Example: opening a LaBounty Shear).

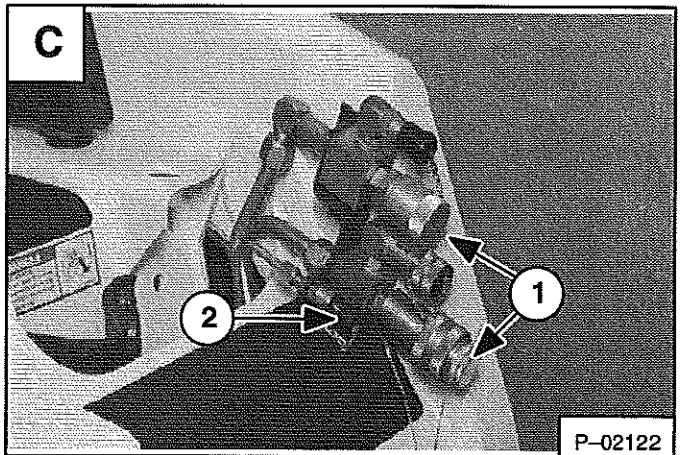
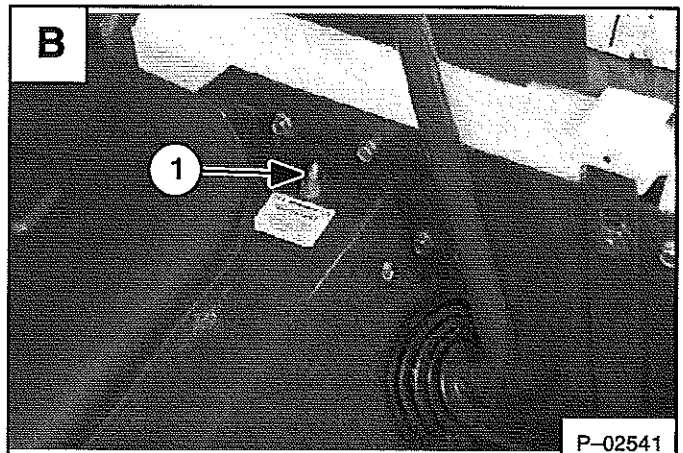
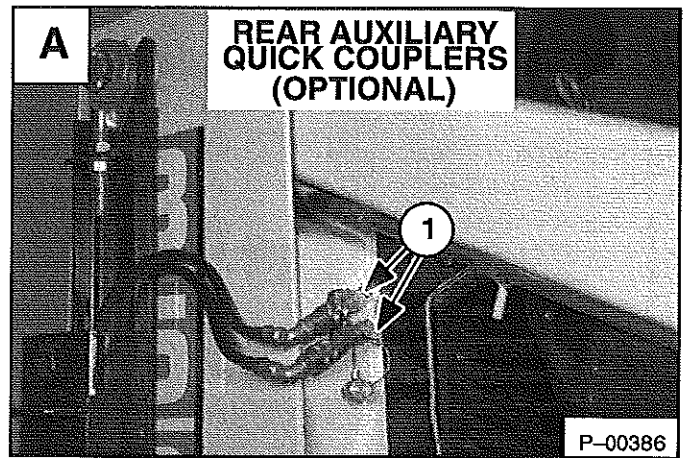

## DAILY INSPECTION

The loader must be in good operating condition [A]. Check the following items:

- Engine Oil
- Hydraulic/Hydrostatic Fluid
- Engine Cooling System
- Operator Cab, Seat Belt, Seat Bar & Pedal Interlocks
- Lift Arm & Cylinder Pivot Pins
- Tires
- Any Loose or Broken Parts
- Safety Tread & Safety Signs
- Check the instrument panel display readout for faulty codes (See *SERVICE CODES* Page 59.)

Follow the maintenance requirements on the Service Schedule Decal, located inside the rear door [B].

**NOTE:** Fluids such as engine oil, hydraulic fluid, coolants, etc. must be disposed of in an environmentally safe manner. Some regulations require that certain spills and leaks on the ground must be cleaned in a specific manner. See local, state and federal regulations for correct disposal.

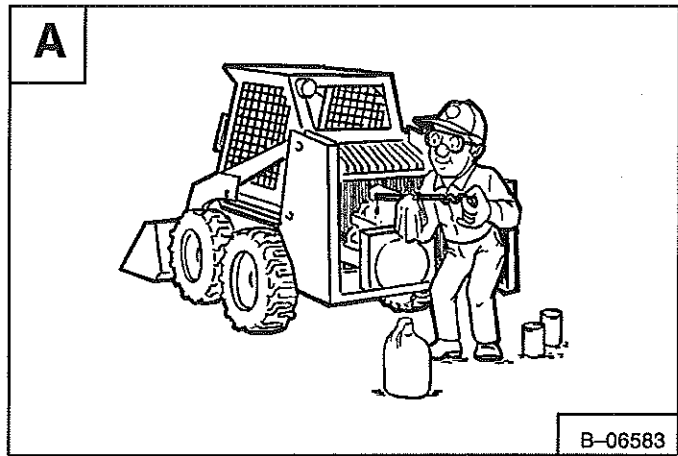

B-06583

## ! WARNING

Instructions are necessary before operating or servicing machine. Read Operation & Maintenance Manuals, Handbook and signs (decals) on machine. Follow warnings and instructions in the manuals when making repairs, adjustments or servicing. Check for correct function after adjustments, repairs or service. Failure to follow instructions can cause injury or death [A].

W-2003-1289

B

## SERVICE SCHEDULE

EVERY 10 HOURS (BEFORE STARTING THE LOADER)

1. Engine Oil — Check level — do not overfill. (See Operation & Maintenance Manual for recommended oil).
2. Engine Air Filter — Check gauge and/or display. Service only when required.
3. Engine Cooling System — Clean debris from oil cooler, radiator and grill. Check coolant level each day. Add 50% propylene glycol premix with 47% water as needed.
4. Loader Lift Arm, cylinders, Bob-Tach pivot and wedges, lubricate with multi-purpose lithium base grease.
5. Engine Air System — Check for leaks and damaged components.
6. General — Check for loose or broken parts, damaged operator cab, instrument operations, loose wheel nuts, oil leaks. Repair or replace as needed.
7. Seat Belt/Seat Bar and Control Interlocks — Check function. Repair or replace as needed. Clean dirt and debris from moving parts.
8. Fuel Filter — Remove trapped water (diesel engine only).
9. BICS — Check for function. Clean dirt, debris or objects from under end back of seat as required.
10. Tires — Check inflation pressure. Inflate tires to the MAXIMUM pressure shown on the sidewall of the tire.

EVERY 50 HOURS

1. Hydraulic Fluid — Check the fluid level. See your Operation & Maintenance Manual for recommended fluid.
2. Chaincase — Check the fluid level. See your Operation & Maintenance Manual for recommended fluid.
3. Battery — Check condition.
4. Controls — Check operation, adjust if needed.
5. Engine Oil (450 Loader Only) — Drain when engine is at operating temperature. See Operation & Maintenance Manual.

EVERY 100 HOURS

1. Spark Arrestor Muffler — Empty spark chamber.
2. Ignition System — If using leaded fuel, check spark plugs and ignition system. If using unleaded fuel, service only as required to maintain good starting and smooth operation (Gas Engine Only).
3. Engine Oil — Drain when engine is at operating temperature and replace filter. See Operation & Maintenance Manual. (Every 200 hours for 700 models with a KUBOTA engine.)
4. Check all belt drives — Water pump and alternator and fan drive for condition and tension. Adjust or replace as needed.
5. Hydraulic/Hydrostatic System (400's and 500's only) — Replace the filter element. NOTE: The filter element must be replaced sooner if transmission warning indicator remains on for more than 5 minutes after hydraulic fluid is at operating temperature.

EVERY 250 HOURS (OR EVERY 12 MONTHS)

1. Final Fuel Filter — Replace filter element.
2. Steering Lever Pivots — Lubricate with multi-purpose lithium based grease (2 places).
3. Transmission Drive Belt — Check and adjust if needed. \*Check replacement drive belt after the first 50 hours of operation and adjust if needed.
4. Drive Line (500's only) — Lubricate U-joint. See Operation & Maintenance Manual for recommended grease.
5. Hydraulic/Hydrostatic System — Replace reservoir breather cap and replace the filter element (550-Replace two (2) filter elements). NOTE: The filter element must be replaced sooner if transmission warning indicator remains on for more than 5 minutes after hydraulic fluid is at operating temperature.

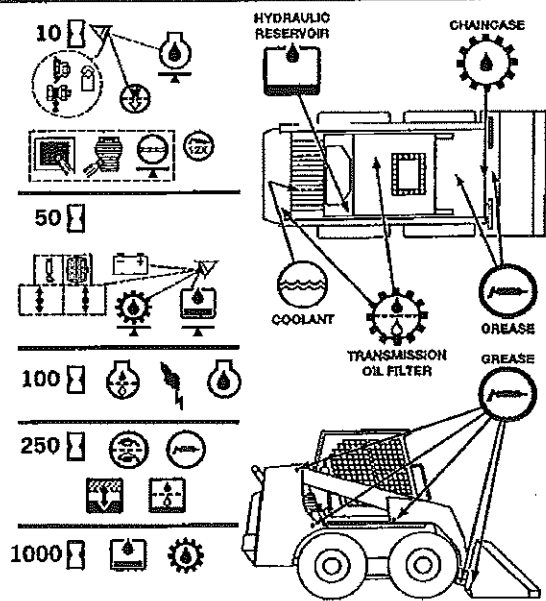

EVERY 1000 HOURS (OR EVERY 12 MONTHS)

1. Hydraulic Reservoir — Replace fluid. See Operation & Maintenance Manual for recommended fluid.
2. Drive Motor Case Drain Filters — Clean or Replace if equipped.
3. Chaincase — Drain fluid and replace. See your Operation & Maintenance Manual for recommended fluid.
4. Fan Drive Belt — Check fluid level. See your Operation & Maintenance Manual for recommended fluid.
5. BICS — Check lift arm bypass control.
6. See the Operation & Maintenance Manual for more instructions. Weitere Anweisungen finden sie in der Bedienungs- und Instandhaltungsanleitung. Para más instrucciones, vea el Manual de Operación y Mantenimiento. Voir le Manuel de l'opérateur et d'entretien pour d'autres renseignements.

SN 95 6108212

6708212

## SEAT BAR RESTRAINT SYSTEM

The seat bar restraint system has a pivoting seat bar (Item 1) [A] with arm rests and has spring loaded interlocks for the lift and tilt control pedals. The operator controls the use of the seat bar. The seat bar in the down position helps to keep the operator in the seat. The interlocks require the operator to lower the seat bar in order to operate the foot pedal controls. When the seat bar is up, the lift and tilt control pedals are locked when returned to the neutral position.

### **WARNING**

#### **AVOID INJURY OR DEATH**

When operating the machine:

- Keep the seat belt fastened snugly.
- The seat bar must be lowered.
- Keep your feet on the pedal controls.

W-2046-0595

The spring loaded interlocks (Item 1) [B] control the locking and unlocking functions of the control pedals.

The interlocks (Item 1) [B] require the operator to lower the seat bar (Item 2) [B] which allows the operator to move the foot pedals to control the lift and tilt functions.

When the seat bar is lowered, it pushes the interlock (Item 1) [B] down on both sides, releasing the pedal linkages (Item 3) [B] from the interlocks.

The pedals will pivot in both directions when the interlock is down.

### **WARNING**

#### **AVOID INJURY OR DEATH**

Before you leave the operator's seat:

- Lower the lift arms, put the attachment flat on the ground.
- Stop the engine.
- Engage the parking brake.
- Raise seat bar, move pedals until both locked.

W-2045-1086

#### **AVOID INJURY OR DEATH**

The seat bar system must lock the lift and tilt control pedals in neutral when the seat bar is up. Service the system if pedals do not lock correctly.

W-2105-1285

When the seat bar is raised, spring forces raise the interlocks [C].

The foot pedals will not pivot when the interlock is up.

See *Seat Bar Inspection* Page 33 and *Seat Bar Maintenance* Page 33.

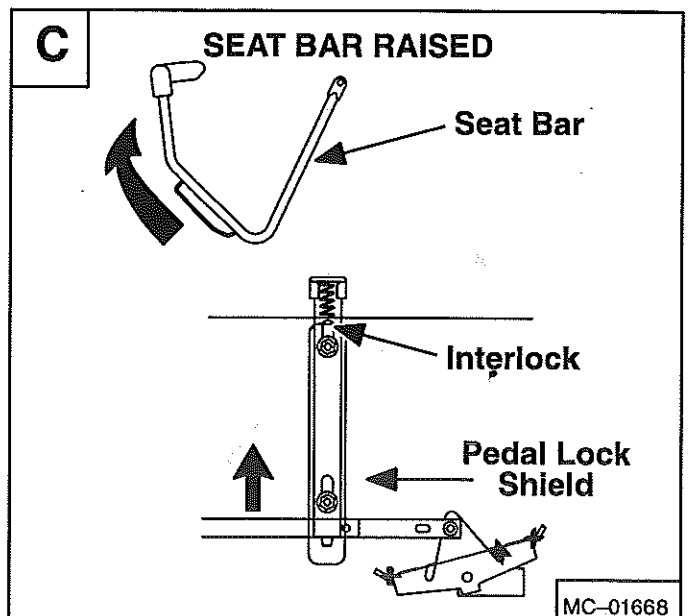
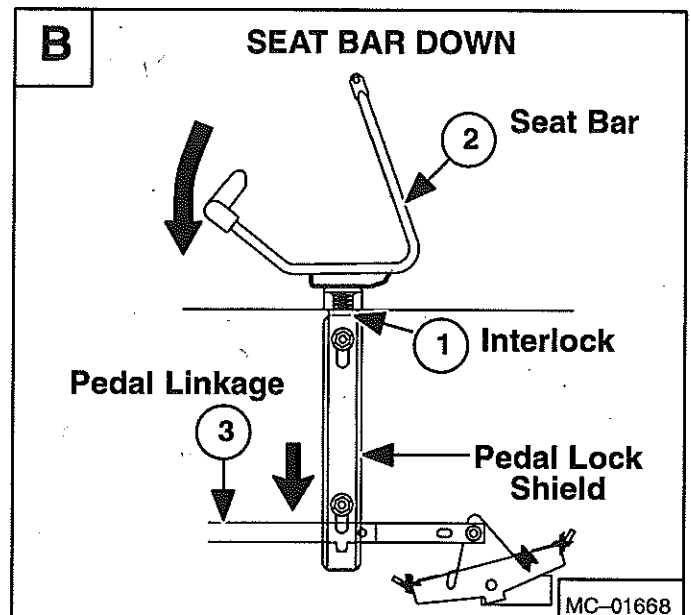
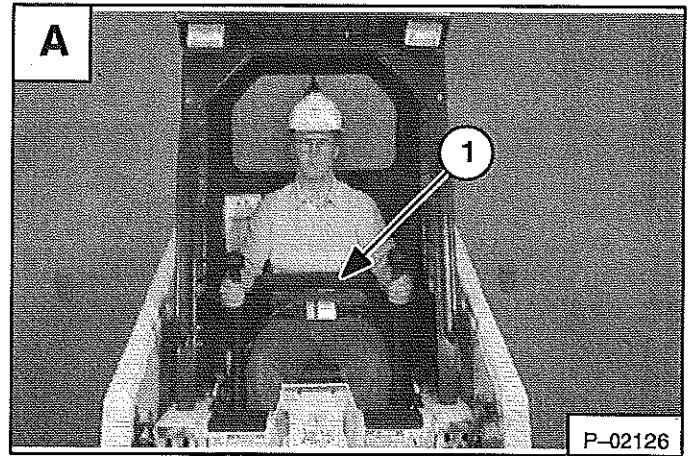



## GETTING READY FOR OPERATION

Read the Operation & Maintenance Manual and the Operator's Handbook before operating the loader [A].

### **WARNING**

Operator must have instructions before running the machine. Untrained operators can cause injury or death.

W-2001-0596

Use the bucket or attachment steps, grab handles and safety treads (on top of the loader lift arms and frame) to get on and off the loader [B].

Safety treads are installed on the Bobcat loader to provide a slip resistant surface for getting on and off the loader. Keep safety treads clean and replace when damaged. Replacement treads are available from your dealer.

Pull the seat lever (Item 1) [C] and adjust the seat position for comfortable operation of the loader controls.

Fasten the seat belt snugly and adjust it so that the buckle is centered between the hips [D].

### **WARNING**

#### **AVOID INJURY OR DEATH**

When operating the machine:

- Keep the seat belt fastened snugly.
- The seat bar must be lowered.
- Keep your feet on the pedal controls.

W-2046-0595

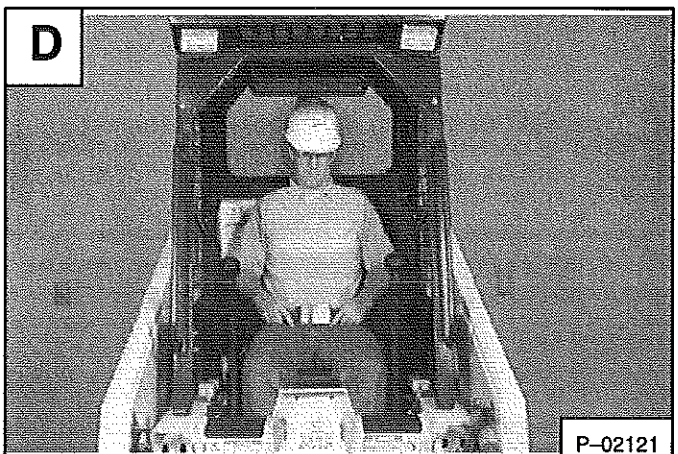
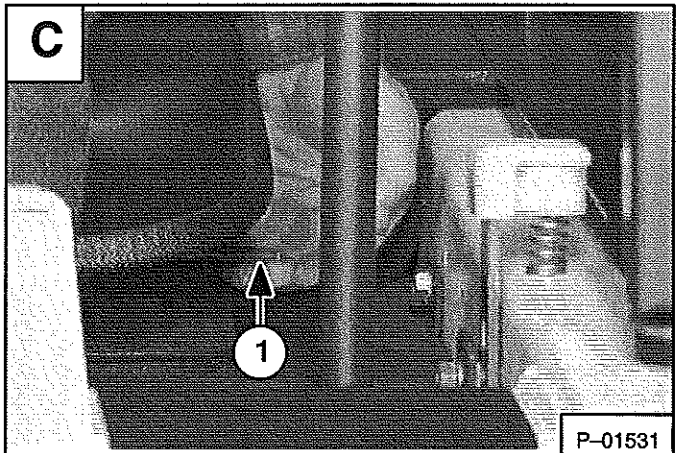
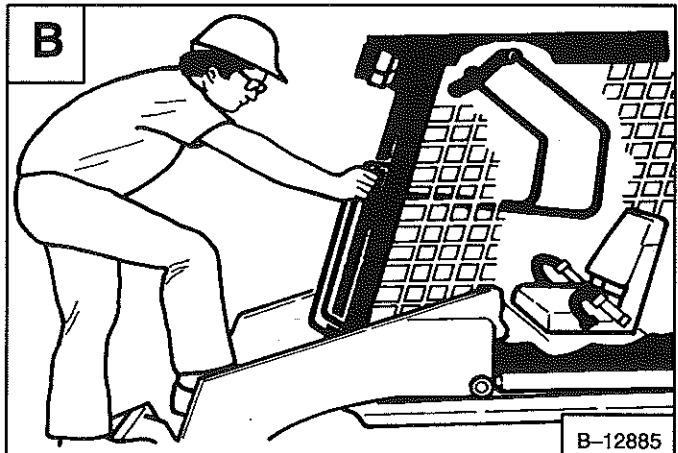
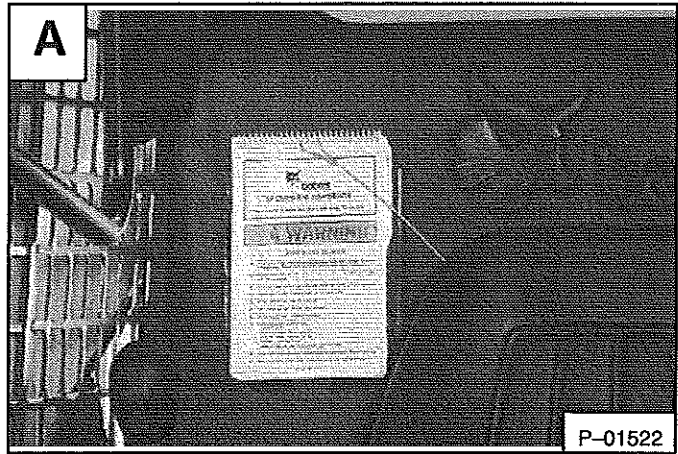

## GETTING READY FOR OPERATION (Cont'd)

Lower the seat bar [A].

All controls must be in the neutral position before you start the engine. (See *Normal Starting Condition* Pages 16 & 18.)

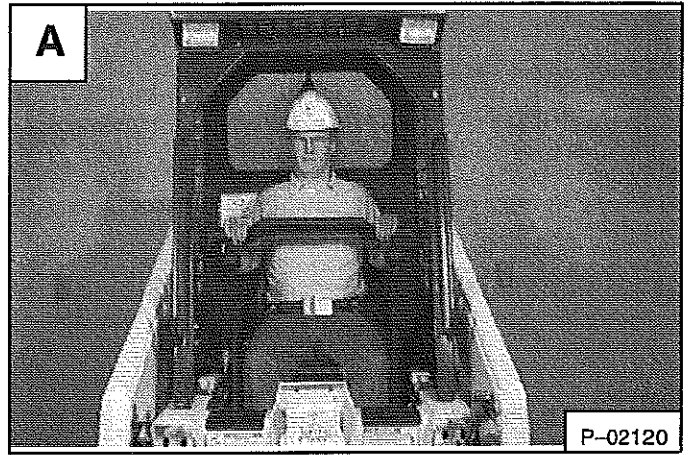

Keep feet on the pedals while seated in the loader [B].

### IMPORTANT

Clean dirt and debris from the foot pedals and surrounding area before operating the loader, to ensure proper operation of the foot pedals.

I-2105-0196

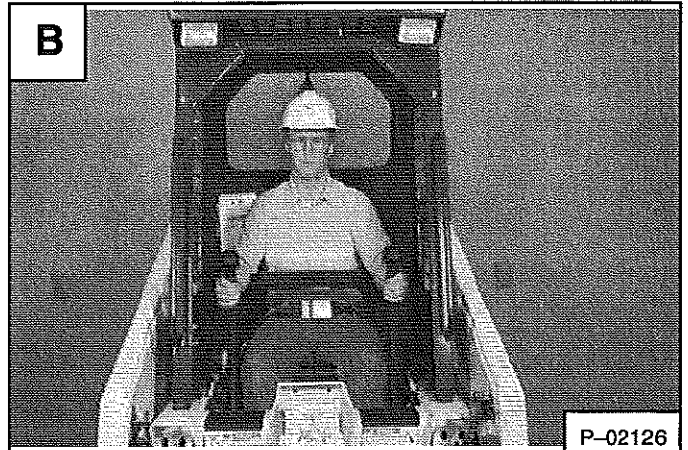

## STARTING THE ENGINE

### ! WARNING

When an engine is running in an enclosed area, fresh air must be added to avoid concentration of exhaust fumes. If the engine is stationary, vent the exhaust outside. Exhaust fumes contain odorless, invisible gases which can kill without warning.

W-2050-1285

#### AVOID INJURY OR DEATH

- Engines can have hot parts and hot exhaust gas. Keep flammable material away.
- Do not use machines in atmosphere containing explosive gas.

W-2051-1086

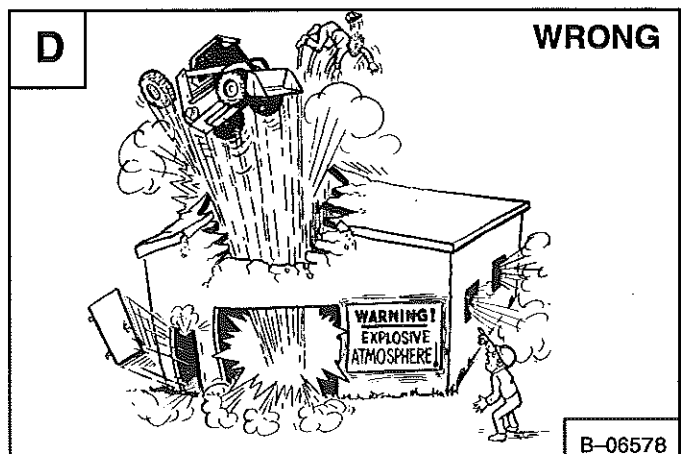
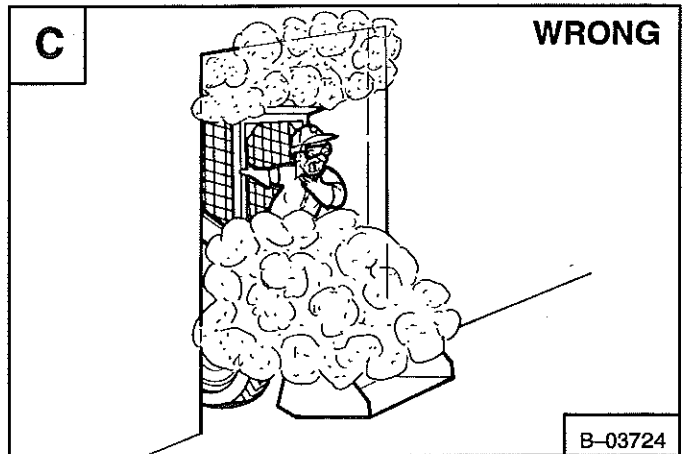

## STARTING THE ENGINE (Cont'd)

### Normal Starting Condition – (Standard)

Adjust the seat position for comfortable operation of the foot pedals and steering levers.

Fasten the seat belt snugly and adjust it so the buckle is centered between the hips.

Lower the seat bar [A].

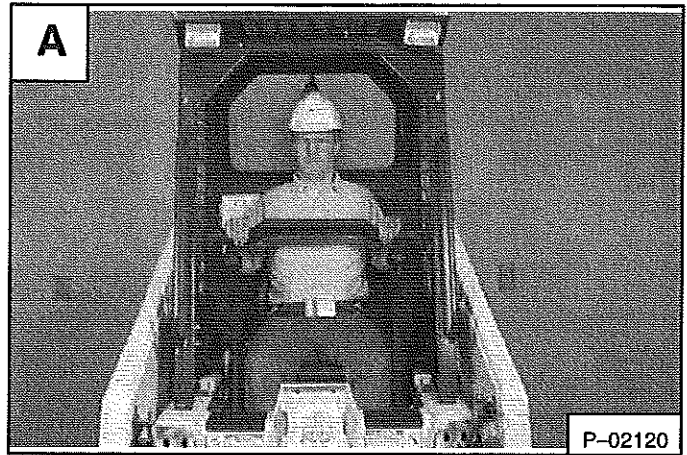

Put the foot pedals and steering levers in neutral (center) position (Item 1) [B].

Set the engine speed control to the half speed position (Item 2) [B].

Turn the key to the ON position. The engine and transmission warning lights will be ON when the key is on and the engine is stopped (Item 3) [B].

Turn the key to start position (Item 4) and release it when the engine starts [B].

## IMPORTANT

Do not engage the starter for longer than 15 seconds at a time. Longer use can damage the starter by overheating. Cool the starter for one minute between uses.

I-2034-0284

When the engine starts, release the key and it will return to the run position (Item 5) [B].

STOP THE ENGINE IF THE WARNING LIGHTS DO NOT GO OFF.

Without turning the key to the START position, turn the key to the RUN position (Item 5) [B] for starting the loader in cold weather. (See *Cold Temperature Starting Condition* Page 17 & 19.)

A

B

### NEUTRAL POSITION



1

### 1/2 THROTTLE



2

### ON POSITION



3

### START POSITION



4

### RUN POSITION



5

PI-02188



## STARTING THE ENGINE (Cont'd)

# ! WARNING

Do not use ether with glow plug (preheat) systems. Explosion can result which can cause injury or death.

W-2071-1285

### Cold Temperature Starting Condition – (Standard)

See *Normal Starting Condition*, Page 18. Turn the key switch to the RUN position.

Push the PREHEAT switch (Item 1) [A] on the left side of the instrument panel to preheat the glow plugs.

Refer to the decal on the left side of the operator cab for operation of the preheat system [B].

Follow the steps under *Normal Starting Condition* and repeat the Preheating procedure until the engine starts.

If the temperature is below 32°F (0°C), use the following procedure to make starting the engine easier:

Replace the engine oil with the correct type and viscosity for the anticipated starting temperature. (See *Oil Specifications*, Page 39.)

Make sure the battery is at full charge.

Install a block or tank heater on the engine.

### Warming The Hydraulic/Hydrostatic System

# IMPORTANT

When the temperature is below -20°F (-30°C), hydrostatic oil must be warmed before starting. The hydrostatic system will not get enough oil at low temperatures and will be damaged. Park the machine in an area where the temperature will be above 0°F (-18°C) if possible.

I-2007-1285

Let the engine run for a minimum of 5 minutes to warm the engine and hydrostatic transmission fluid before operating the loader. If the warning light comes ON when operating the loader (cold), more warm up time is needed.

A

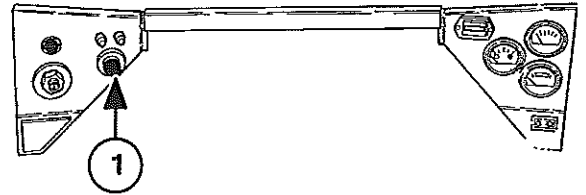

B-13752

B

KEY SWITCH PRE-HEAT POSITION	PRE-HEAT BUTTON	AIR TEMP.	PRE-HEAT TIME
		70°F (21°C) & Above	NO TIME
		60°F to 70°F (10° to 21°C)	5 SECONDS
		0°F to 50°F (-18° to 10°C)	15 SECONDS
		0°F (-18°) & Below	25 SECONDS

SEE OPERATION & MAINTENANCE MANUAL FOR MORE INSTRUCTIONS. 6705712

6705712

## STARTING THE ENGINE (Cont'd)

### Normal Starting Condition – (Optional)

Adjust the seat position for comfortable operation of the foot pedals and steering levers.

Fasten the seat belt snugly and adjust it so the buckle is centered between the hips.

Lower the seat bar [A].

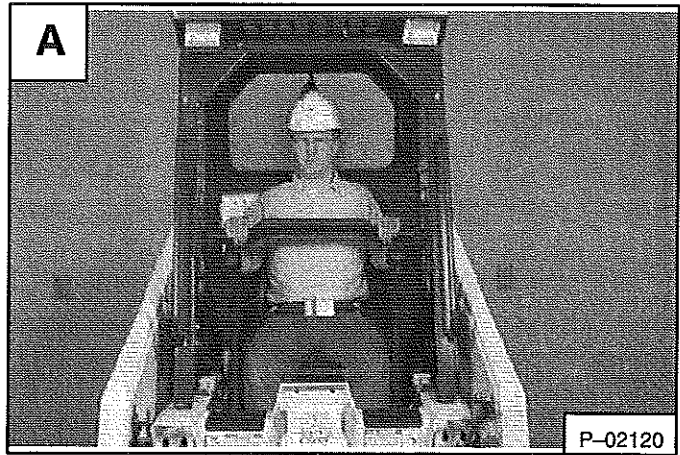

Put the foot pedals and steering levers in neutral (Center) position (Item 1) [B].

Set the engine speed control to 1/2 speed position (Item 2) [B].

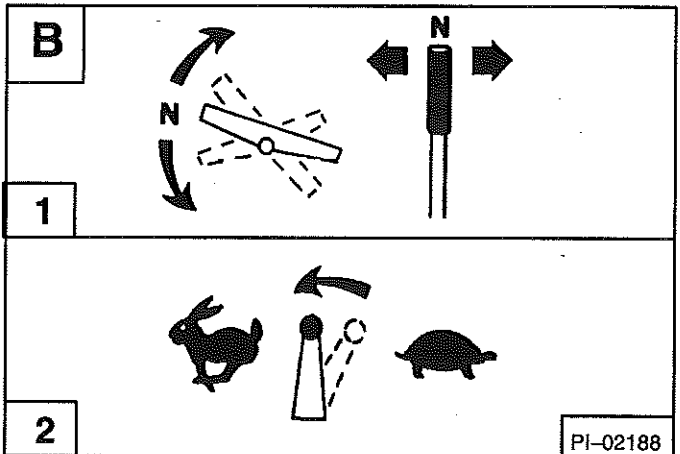

Turn the key to the ON position, one beep will sound and the display symbols will be ON [C]. Turn the key to START. (See *Cold Temperature Starting Condition* Pages 17 & 19.) Release the key when the engine starts.

## IMPORTANT

Do not engage the starter for longer than 15 seconds at a time. Longer use can damage the starter by overheating. Cool the starter for one minute between uses.

I-2034-0284

When the key is turned ON and the alpha numeric display will show various readout codes for three second intervals each. The readout codes are from the previous work shift when a WARNING may have occurred. (See *SERVICE CODES* Page 59.)

The readout codes may be viewed again by turning the key switch OFF and then ON again without starting the engine.

Once the engine is started, the microprocessor will clear out all the codes from memory. The codes will not reappear in subsequent key ON conditions unless the problem recurs.

When the readout codes are completed, the numerical display will return to the operating hours.

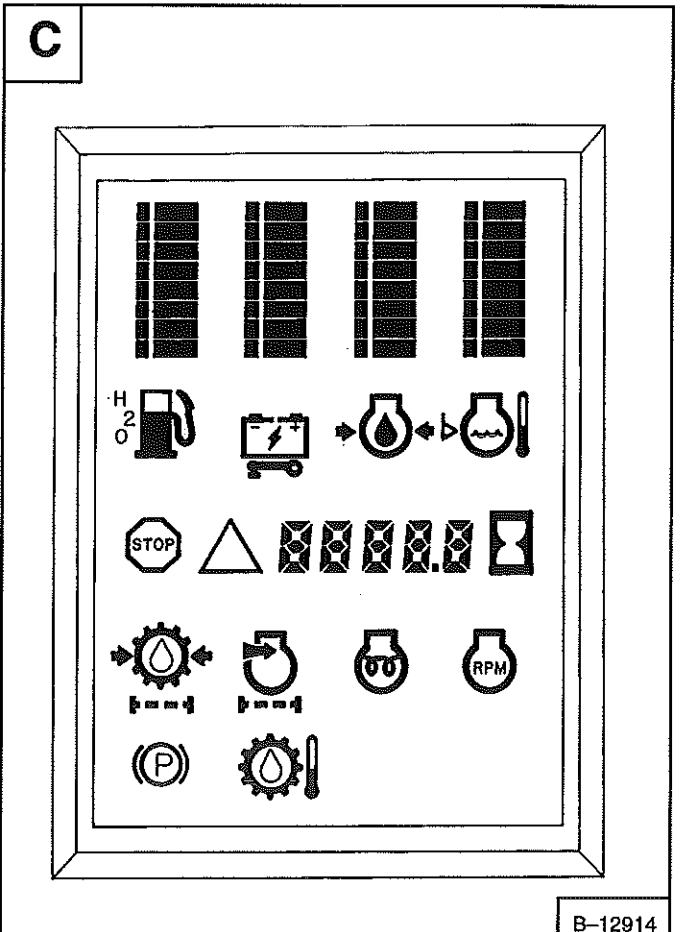

## STARTING THE ENGINE (Cont'd)

### Cold Temperature Starting Condition (Optional)

# ! WARNING

Do not use ether with glow plug (preheat) systems. Explosion can result which can cause injury or death.

W-2071-1285

See *Normal Starting Condition* Pages 17. Turn the key switch to the ON position (readout codes will show first) and the glow plug signal will be ON [A].

**NOTE:** If display is showing readout codes (see above description), the timing of the glow plug activation may be obscured on the display. However the glow plugs will actually be energized.

The alpha numeric display will indicate the characters **GLOXX** where **XX** will show remaining time the glow plugs will be energized. The following chart shows the time glow plugs will be energized dependent on engine coolant temperature.

COOLANT TEMPERATURE	GLOW PLUG ON TIME
0°F. (-18°C.) & Below	25 Seconds
0°-50°F. (-18°-10°C.)	15 Seconds
50°-70°F. (10°-21°C.)	5 Seconds
70°F (21°C) & Above	NO TIME

Turn the key to the START position and release when the engine starts. If the engine does not start, turn the key switch to the OFF position and ON again to cycle the glow plugs again. When the engine is running, slowly move the engine speed control forward to increase the RPM.

If the starting temperature is below 32° F (0° C), use the following procedure to make starting easier:

Replace the engine oil with the correct type and viscosity for the anticipated starting temperature. (See *Checking Engine Oil* Page 39.)

Make sure the battery is at full charge.

Install an engine block heater or tank heater.

### STOPPING THE ENGINE

Pull the throttle fully backward to decrease the engine RPM. Turn the key switch to the OFF position.

A

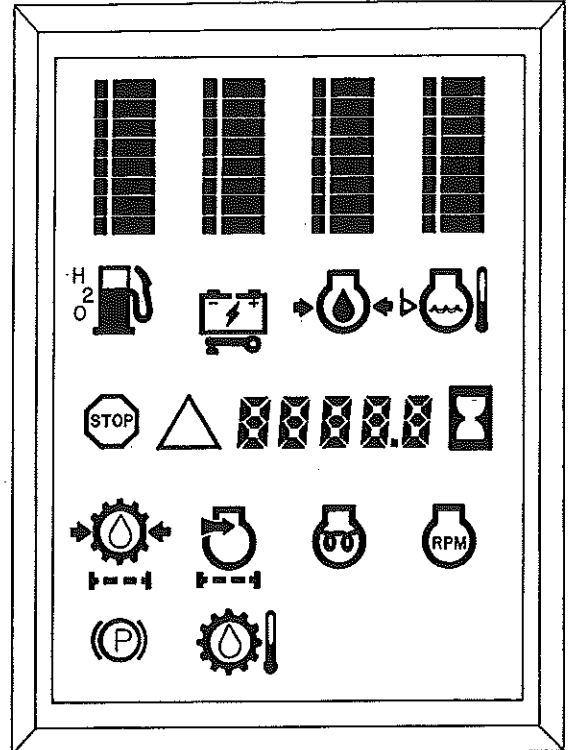

B-12914

# IMPORTANT

When the temperature is below -20°F (-30°C), hydrostatic oil must be warmed before starting. The hydrostatic system will not get enough oil at low temperatures and will be damaged. Park the machine in an area where the temperature will be above 0°F (-18°C) if possible.

I-2007-1285

## ATTACHMENTS AND BUCKETS

! **WARNING**

Never use attachments or buckets which are not approved by Melroe Company. Buckets and attachments for safe loads of specified densities are approved for each model. Unapproved attachments can cause injury or death.

W-2052-1285

The dealer can identify, for each model loader, the attachments and buckets approved by Melroe Company. The buckets and attachments are approved for Rated Operating Capacity and for secure fastening to the Bob-Tach.

The Rated Operating Capacity for this loader is shown on a label in the operator cab. (See *SPECIFICATIONS*, Page 71.)

It is determined by using a standard dirt bucket, and material of normal density, such as dirt or dry gravel. If longer buckets are used and load center moves forward and reduces the Rated Operating Capacity. If very dense material is loaded, the volume must be reduced.

Exceeding the Rated Operating Capacity can cause the following problems:

1. Steering the loader may be difficult.
2. Tires may wear faster.
3. There will be a loss of stability.
4. The life of the Bobcat loader will be reduced.

Use the correct size bucket for the type and density of material being handled. For safe handling of materials and avoiding machine damage, the attachment (or bucket) should handle a full load without going over the Rated Operating Capacity for the loader. Partial loads make steering more difficult.

Maximum loads to be carried when using a pallet fork are shown in figure [B].

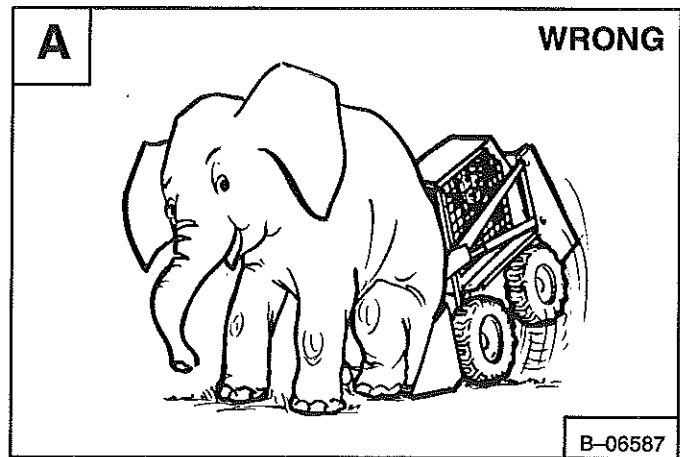

! **WARNING**

AVOID INJURY OR DEATH

Do not exceed rated operating capacity. Excessive load can cause tipping or loss of control.

W-2053-0887

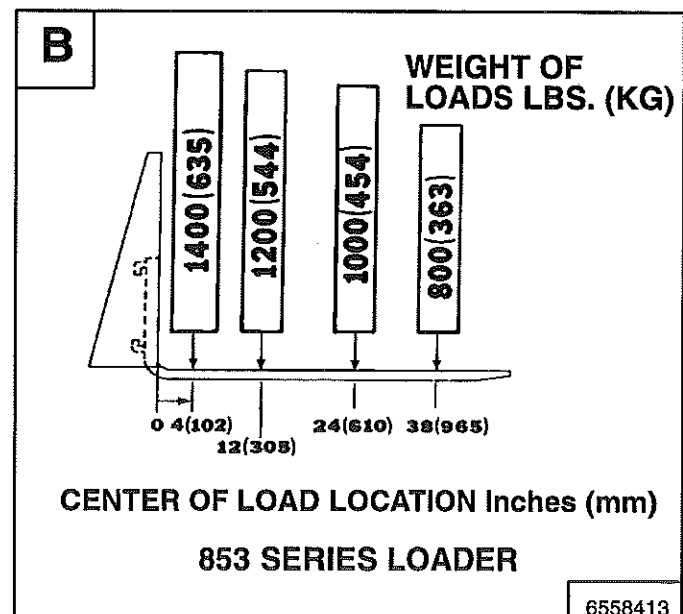

## ATTACHMENTS AND BUCKETS (Cont'd)

### Installation And Removal

The loader is equipped with the Bob-Tach system. The Bob-Tach is used for fast changing of buckets and attachments. See the Attachment Operation & Maintenance Manual to install other attachments.

#### **WARNING**

Bob-Tach levers have spring tension. Hold lever tightly and release slowly. Failure to obey warning can cause injury.

W-2054-1285

Pull the Bob-Tach levers all the way up.

Tilt the Bob-Tach forward. Drive the loader forward until the top edge of the Bob-Tach is completely under the flange of the bucket [A].

DO NOT hit the Bob-Tach levers on the bucket.

Tilt the Bob-Tach backward until the bucket is off the ground [B]. Stop the engine.

#### **WARNING**

##### **AVOID INJURY OR DEATH**

Before you leave the operator's seat:

- Lower the lift arms, put the attachment flat on the ground.
- Stop the engine.
- Engage the parking brake.
- Raise seat bar, move pedals until both locked.

W-2045-1086

Push down on the Bob-Tach levers until they are in the locked position [C]. Inset [C] is locked position.

#### **WARNING**

Bob-Tach wedges must extend through the holes in attachment. Lever(s) must be fully down and locked. Failure to secure wedges can allow attachment to come off and cause injury or death.

W-2102-0497

The wedges (Item 1) [D] must extend through the holes in the bucket or attachment.

Removal: Reverse the above procedure to remove the bucket or attachment from the Bob-Tach.

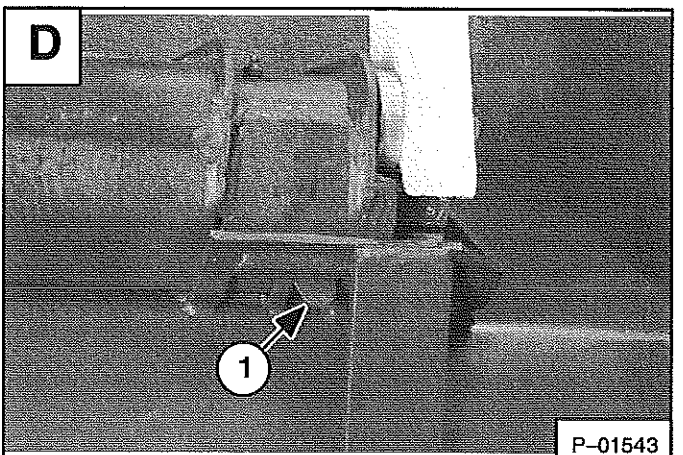
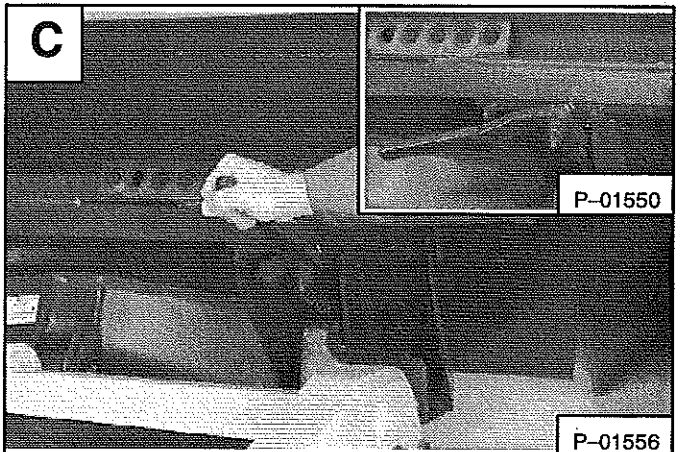
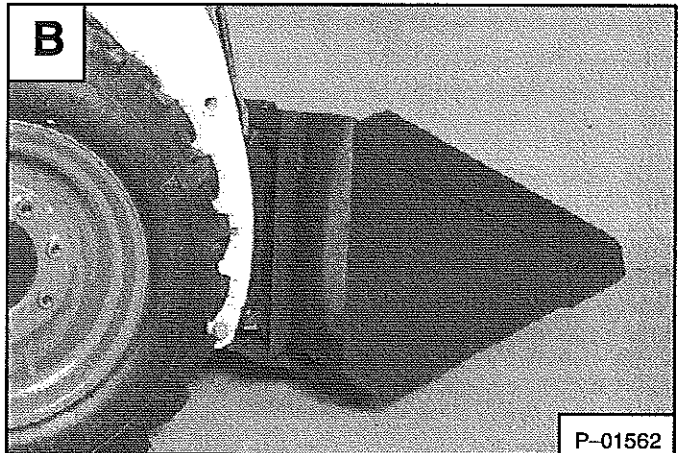
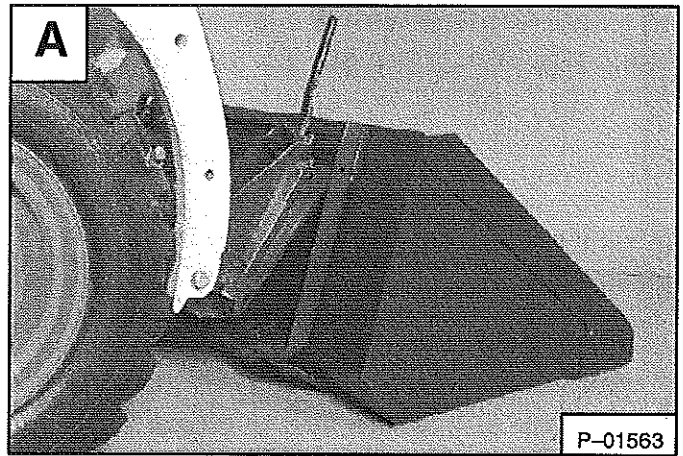

## OPERATING PROCEDURES

When operating on a public road or highway, always follow local regulations. For example: Slow Moving Vehicle Sign or Directional Signals may be required.

Always warm up the engine and hydrostatic system before operating the loader.

# IMPORTANT

Machines warmed up with moderate engine speed and light load have longer life.

I-2015-0284

Operate the loader with the engine at full speed for maximum horsepower. Move the steering levers only a small amount to operate the loader slowly.

New operators must operate the loader in an open area without bystanders. Operate the controls until the loader can be handled at an efficient and safe rate for all conditions of the work area.

With a full bucket, go up to down the slope with the heavy end toward the top of the slope [A] & [B].

With empty bucket, go down or up the slope with the heavy end toward the top of the slope [C] & [D].

# ! WARNING

## AVOID INJURY OR DEATH

- Keep the lift arms as low as possible.
- Do not travel or turn with the lift arms up.
- Turn on level ground.
- Go up and down slopes, not across them.
- Keep the heavy end of the machine uphill.
- Do not overload the machine.

Failure to obey warnings can cause the machine to tip or roll over and cause injury or death.

W-2018-1187

Raise the bucket only high enough to avoid obstructions on rough ground.

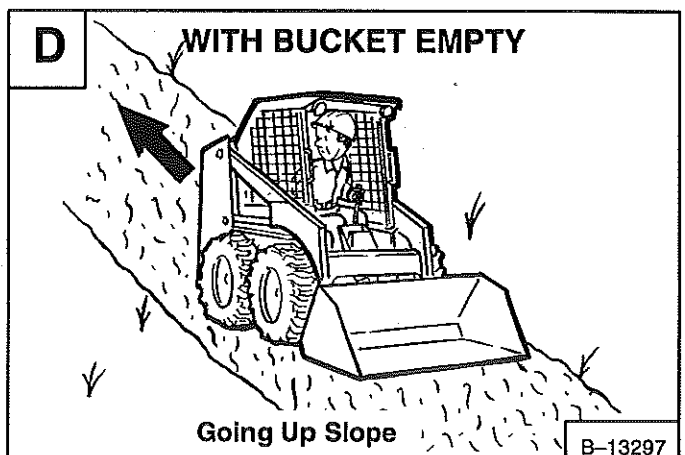
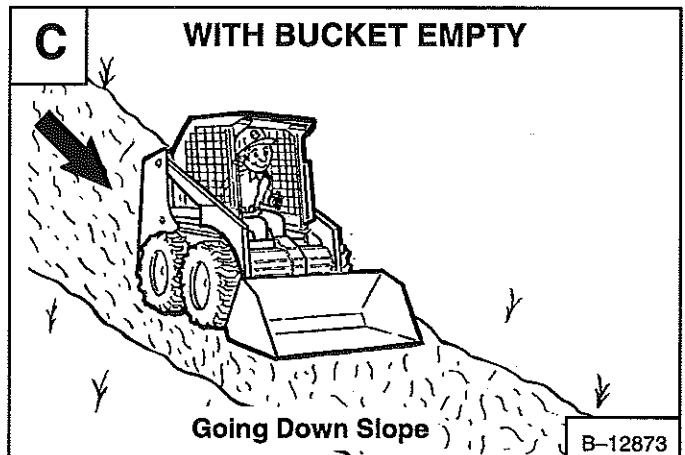
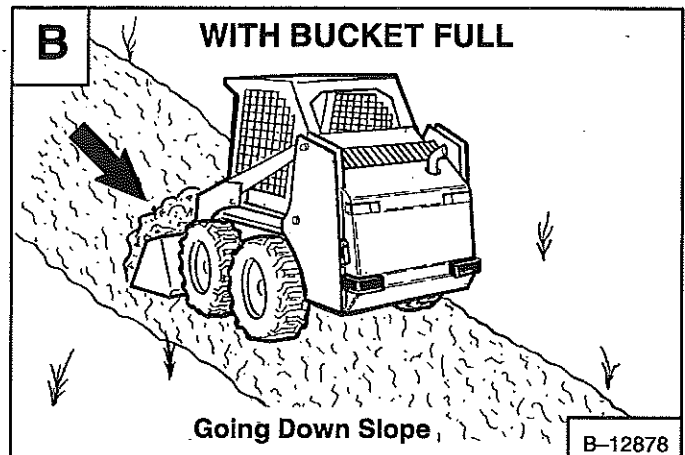
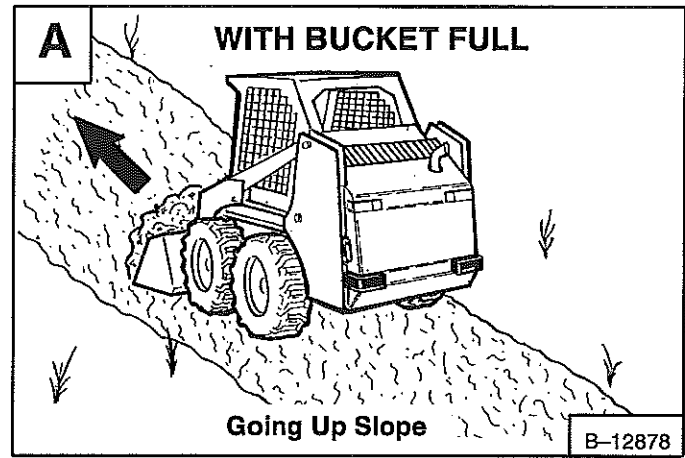

## OPERATING PROCEDURES (Cont'd)

### Filling The Bucket

Push down on the top of the lift pedal until the lift arms are all the way down. Push the top of the tilt pedal to put the cutting edge of the bucket on the ground [A].

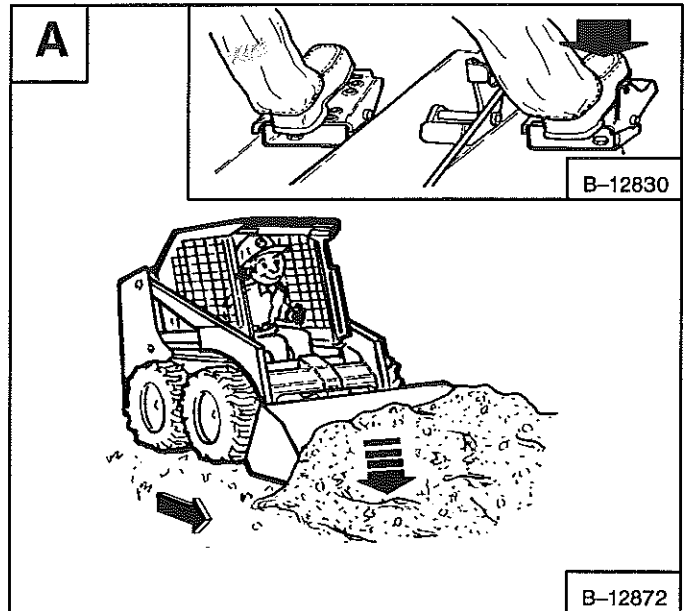

Drive slowly forward into the material. Push the bottom of the tilt pedal to raise the front of the bucket [B].

## **! WARNING**

Load, unload and turn on flat level ground. Do not exceed rated operating capacity shown on sign (decal) in cab. Failure to obey warnings can cause the machine to tip or roll over and cause injury or death.

W-2056-1187

Drive backward away from the material.

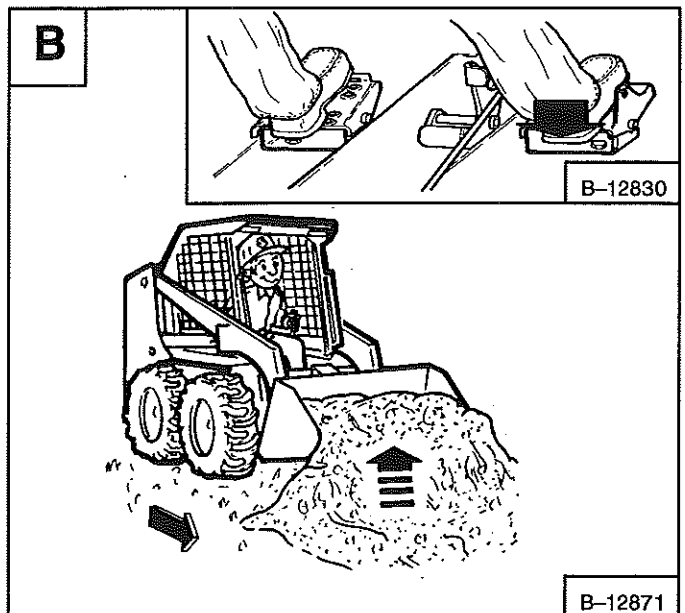

### Emptying The Bucket

Push down on the bottom of the lift pedal to raise the bucket over the truck box or bin [C].

Drive forward slowly until the bucket is over the top of the truck box or bin. Push the top of the tilt pedals until the bucket is empty [C]. If all the material is near the side of the truck or bin, push it to the other side with the bucket.

## **! WARNING**

Never dump over an obstruction, such as a post, that can enter the operator cab. The machine could tip forward and cause injury or death.

W-2057-0694

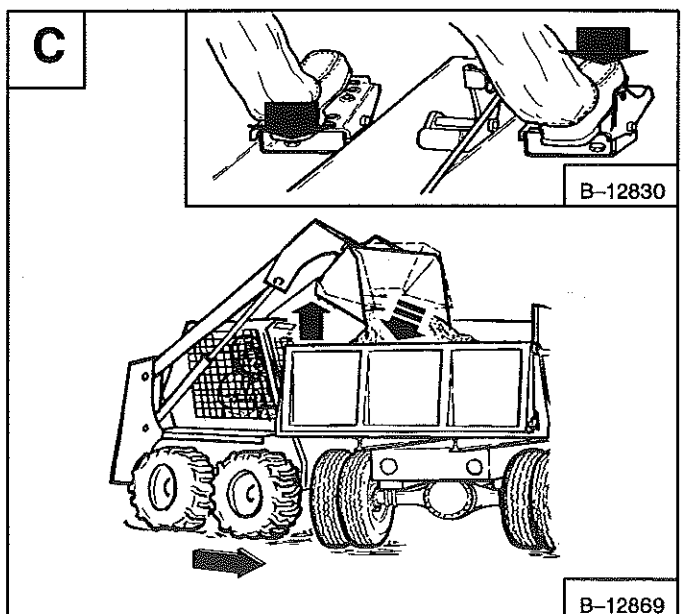



## OPERATING PROCEDURES (Cont'd)

### Digging Into The Ground

Put the lift arms all the way down. Push the top of the tilt pedal until the cutting edge of the bucket is on the ground. Drive forward slowly and continue to tilt the bucket down until it enters the ground [A].

Push the bottom of the tilt pedal a small amount to increase traction and keep an even digging depth. Continue to drive forward until the bucket is full. When the ground is hard, raise and lower the cutting edge of the bucket with the tilt pedal while driving forward slowly.

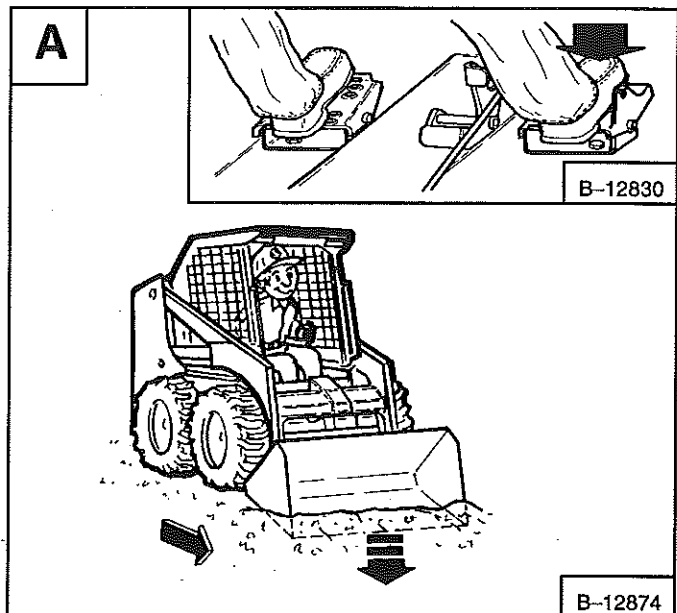

Push the bottom of the tilt pedal to tilt the bucket backward as far as it will go when the bucket is full [B].

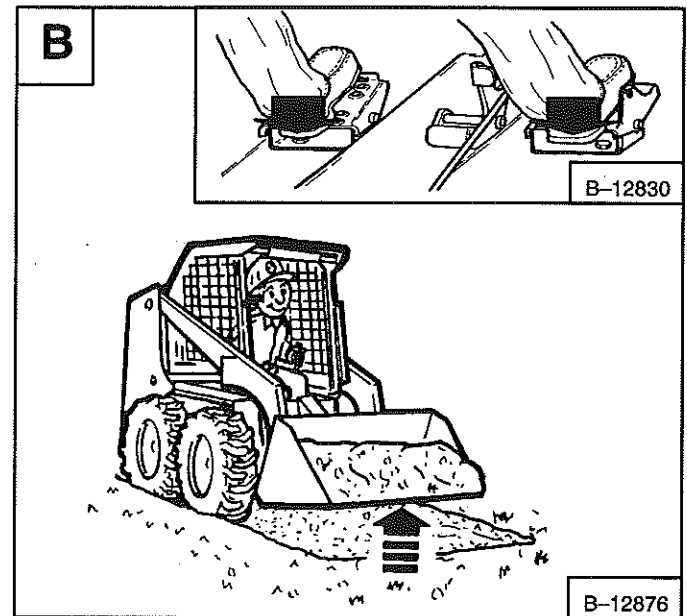

### Leveling The Ground (Using Lift Arms In Float Position)

Push the top (toe) of the lift pedal all the way forward until the pedal is in the locked position (detent) to put the lift arms in a *float* position [C].

Push the tilt pedal to change the position of the cutting edge on the bucket. With the bucket tilted farther forward, there is more force on the cutting edge and more loose material can be moved.

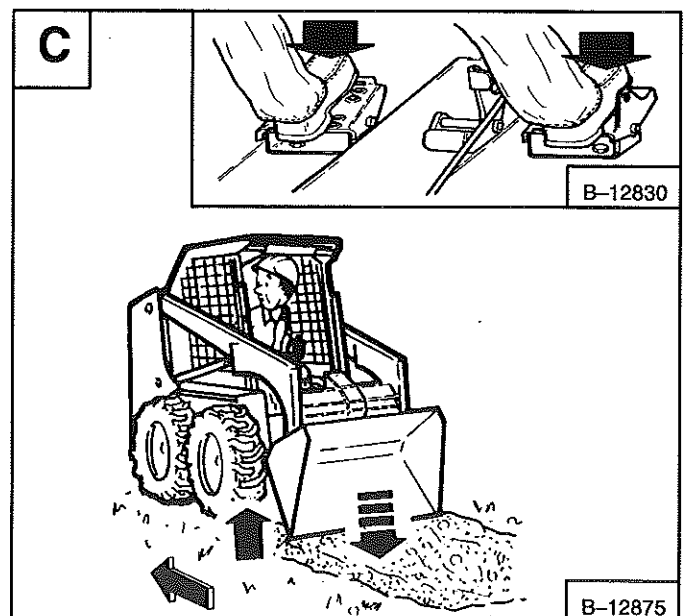

## IMPORTANT

Never drive forward when the hydraulic control for lift arms is in float position.

I-2005-1285

Drive backward to level loose material. Push the bottom of the lift pedal to unlock from the *detent* position.



## OPERATING PROCEDURES (Cont'd)

### Backfilling

Lower the lift arms and put the cutting edge of the bucket on the ground. Drive forward to the edge of the hole to push the material into the hole [A].

Tilt the bucket forward as soon as it is past the edge of the hole [A]. If necessary, raise the lift arms to empty the bucket.

### PARKING THE BOBCAT LOADER

Stop the Bobcat loader on level ground.

Lower the lift arms fully and put the edge of the bucket on the ground.

Pull the engine speed control all the way backward. Turn the key switch to the OFF position.

## WARNING

### AVOID INJURY OR DEATH

Before you leave the operator's seat:

- Lower the lift arms, put the attachment flat on the ground.
- Stop the engine.
- Engage the parking brake.
- Raise seat bar, move pedals until both locked.

W-2045-1086

Engage the parking brake.

Lift the seat bar and make sure the foot pedals are in the locked position.

Unbuckle the seat belt. Remove the key from the switch to prevent operation of the loader by unauthorized personnel.

### TRANSPORTING THE BOBCAT LOADER

## WARNING

Adequately designed ramps of sufficient strength are needed to support the weight of the machine when loading onto a transport vehicle. Wood ramps can break and cause personal injury.

W-2058-0494

A loader with an empty bucket or no attachment must be loaded backward onto the transport vehicle [B].

The rear of the trailer must be blocked or supported [B] when loading or unloading the loader to prevent the front end of the trailer from raising up.

Use the following procedure to fasten the Bobcat loader to the transport vehicle to prevent the loader from moving during sudden stops or when going up or down slopes.

Lower the bucket or attachment to the floor [C].

Stop the engine. Engage the parking brake. Install chains at the front and rear of the loader and to the transport vehicle.

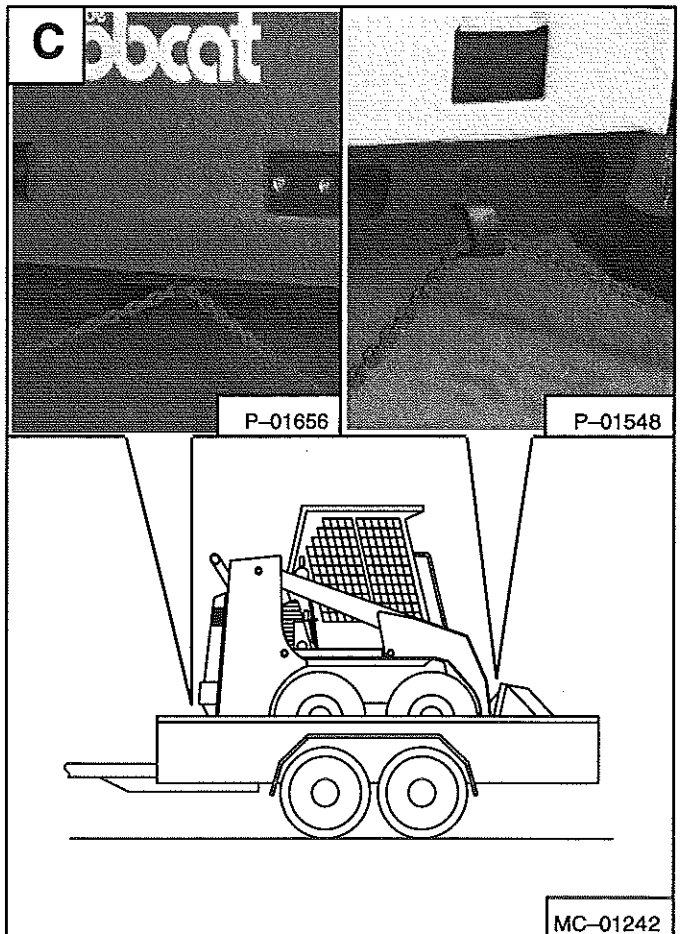
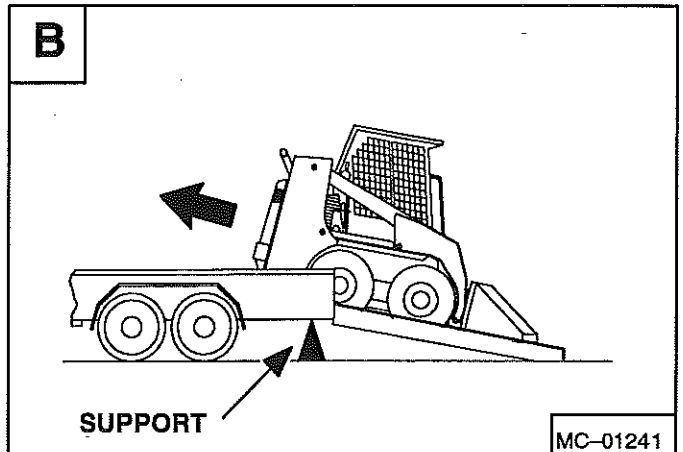
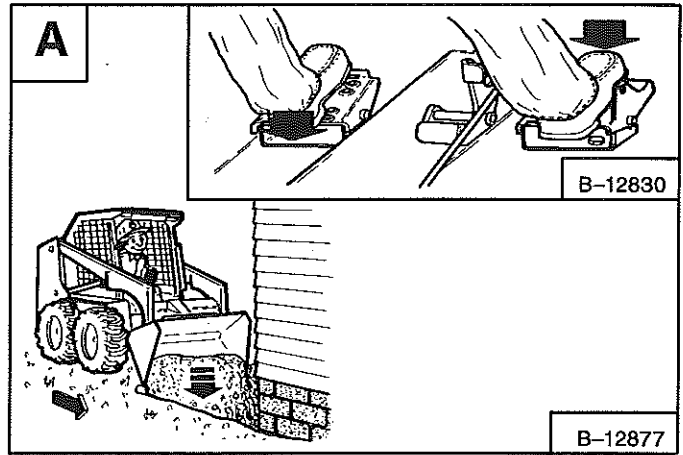

## LIFTING THE LOADER

### Four Point Lift

! **WARNING**

**AVOID INJURY OR DEATH**

When operating the machine:

- Keep the seat belt fastened snugly.
- The seat bar must be lowered.
- Keep your feet on the pedal controls.

W-2046-0595

The loader can be lifted with the four point lift which is available as a kit from your Bobcat loader dealer.

Install the lift eyes [A] in the kit as shown.

### Single Point Lift

! **WARNING**

**AVOID INJURY OR DEATH**

- Before lifting, check fasteners on single point lift and operator cab.
- Assemble front cab fasteners as shown in this manual.
- Never allow riders in the cab or bystanders within 15 feet (5 meters) while lifting the machine.

W-2007-0497

The loader can also be lifted with the single point lift which is available as a kit from your Bobcat loader dealer.

Install the kit and lift as shown [B].

The single point lift, supplied by Melroe Company is designed to lift and support the Bobcat loader without affecting roll over and falling object protection features of the operator cab.

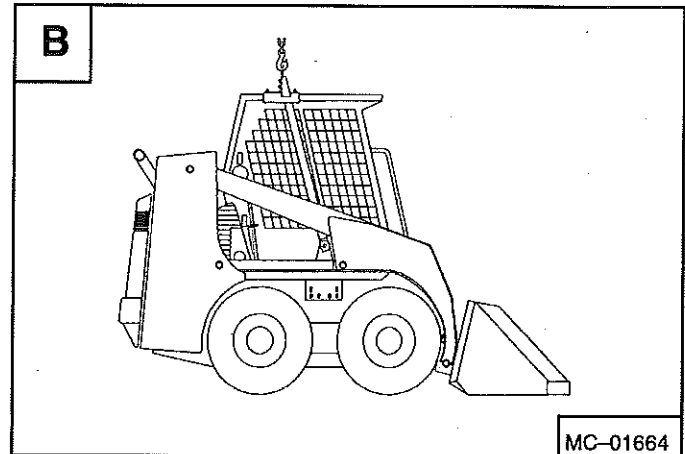
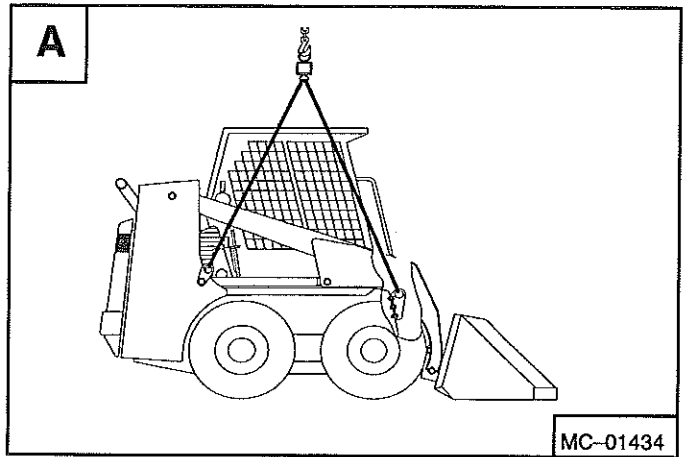

## PREVENTIVE MAINTENANCE

AIR CLEANER SERVICE .....	35
Optional .....	35
Standard .....	35
Servicing The Air Cleaner .....	36
ALTERNATOR BELT .....	43
Adjusting The Alternator Belt .....	43
BOB-TACH .....	55
COOLING SYSTEM .....	41
Checking The Coolant Level .....	41
Cleaning The Cooling System .....	41
Removing Coolant From The Cooling System .....	42
DRIVE BELT .....	52
Adjustment .....	52
Drive Belt Replacement .....	52
ELECTRICAL SYSTEM .....	44
Battery Removal And Installation .....	46
Description .....	44
Servicing The Electrical System .....	44
Fuses Location .....	44
Using A Booster Battery (Jump Starting) .....	45
ENGINE LUBRICATION SYSTEM .....	39
Checking Engine Oil .....	39
Replacing Oil And Filter .....	39
FAN GEARBOX .....	51
FINAL DRIVE TRANSMISSION (CHAINCASE) .....	51
Checking And Adding Oil .....	51
FUEL SYSTEM .....	37
Filling The Fuel Tank .....	37
Fuel Filter .....	37
Fuel Specifications .....	37
Removing Air From The Fuel System .....	38
HYDRAULIC/HYDROSTATIC SYSTEM .....	47
Checking And Adding Fluid .....	47
Hydraulic/Hydrostatic Filter Replacement .....	47
Hydraulic Fluid Replacement .....	48
Hydraulic Reservoir Breather Cap .....	48
LIFT ARM SUPPORT DEVICE .....	30
To Disengage The Lift Arm Support Device .....	30
To Engage The Lift Arm Support Device .....	30
LUBRICATION OF THE BOBCAT LOADER .....	53
OPERATOR CAB .....	31
Emergency Exit .....	32
Lowering The Operator Cab .....	31
Raising The Operator Cab .....	31
PARKING BRAKE PEDAL .....	55
Adjustment .....	55
PIVOT PINS .....	54
REAR DOOR .....	34
Adjustment .....	34
REAR GRILL .....	34
SEAT BAR RESTRAINT SYSTEM .....	33
Seat Bar Inspection .....	33
Seat Bar Maintenance .....	33
SERVICE SCHEDULE .....	29
SPARK ARRESTOR MUFFLER .....	49
TIRE MAINTENANCE .....	50
Tire Mounting .....	50
Tire Rotation .....	50
Wheel Nuts .....	50

**PREVENTIVE  
MAINTENANCE**

# MAINTENANCE SAFETY

## ⚠ WARNING

Instructions are necessary before operating or servicing machine. Read Operation & Maintenance Manual, Handbook and signs (decals) on machine. Follow warnings and instructions in the manuals when making repairs, adjustments or servicing. Check for correct function after adjustments, repairs or service. Failure to follow instructions can cause injury or death.

W-2003-0797

▲ **Safety Alert Symbol:** This symbol is used for important safety messages. When you see this symbol, follow the safety message to avoid personal injury or death.

### CORRECT

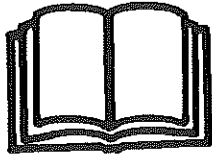

B-10731

▲ Never service the Bobcat® Skid Steer Loader without instructions.

### CORRECT

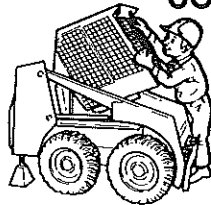

B-12365

▲ Use the correct procedure to lift or lower operator cab with lift arms down.

### CORRECT

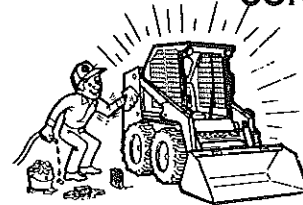

B-7469

▲ Cleaning and maintenance are required daily.

### WRONG

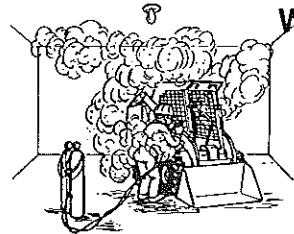

B-11799

▲ Have good ventilation when welding or grinding painted parts.  
▲ Wear dust mask when grinding painted parts. Toxic dust and gas can be produced.

### WRONG

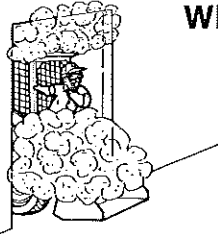

B-3724

▲ Vent exhaust to outside when engine must be run for service.  
▲ Avoid exhaust fume leaks which can kill without warning. Exhaust system must be tightly sealed.

### WRONG



B-6593

▲ Never work on loader with lift arms up unless lift arms are held by a lift arm support device.  
▲ Never modify equipment or add attachments not approved by Melroe Company.

### WRONG

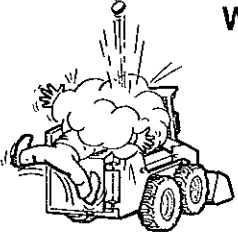

B-6590

▲ Stop, cool and clean engine of flammable materials before checking fluids.  
▲ Never service or adjust loader with the engine running unless instructed to do so in the manual.  
▲ Avoid contact with leaking hydraulic fluid or diesel fuel under pressure. It can penetrate the skin or eyes.  
▲ Never fill fuel tank with engine running, while smoking or when near open flame.

### WRONG

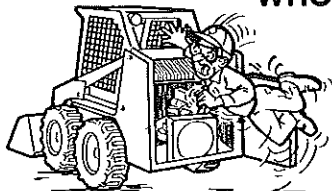

B-6580

▲ Keep body, jewelry and clothing away from moving parts, electrical contacts, hot parts and exhaust.  
▲ Wear eye protection to guard from battery acid, compressed springs, fluids under pressure and flying debris when engines are running or tools are used. Use eye protection approved for type of welding.  
▲ Keep rear door closed except for service. Close and latch door before operating the loader.

### WRONG



B-6589

▲ Lead-acid batteries produce flammable and explosive gases.  
▲ Keep arcs, sparks, flames and lighted tobacco away from batteries.  
▲ Batteries contain acid which burns eyes or skin on contact. Wear protective clothing. If acid contacts body, flush well with water. For eye contact flush well and get immediate medical attention.

Maintenance procedures which are given in the Operation & Maintenance Manual can be performed by the owner/operator without any specific technical training. Maintenance procedures which are **not** in this manual must be performed **ONLY BY QUALIFIED BOBCAT SERVICE PERSONNEL**. Always use genuine Bobcat replacement parts.

8-96

## SERVICE SCHEDULE

Maintenance work must be done at regular intervals. Failure to do so will result in excessive wear and early failures. The service schedule is a guide for correct maintenance of the Bobcat loader.

### **WARNING**

Instructions are necessary before operating or servicing machine. Read Operation & Maintenance Manual, Handbook and signs (decals) on machine. Follow warnings and instructions in the manuals when making repairs, adjustments or servicing. Check for correct function after adjustments, repairs or service. Failure to follow instructions can cause injury or death.

W-2003-0797

SERVICE SCHEDULE		HOURS				
ITEM	SERVICE REQUIRED	8-10	50	100	250	1000
Engine Oil	Check the oil level & add oil as needed.					
Air Cleaner	Check display or condition indicator. Service only when required.					
Engine Cooling System	Clean debris from oil cooler, radiator & grill. Check coolant level cold in recovery tank. Add 50/50 ethylene glycol & water as needed.					
Lift Arms, Cyl., Bob-Tach Pivot Pins & Wedges	Lubricate with multipurpose lithium based grease (12 places).					
Engine Air System	Check for leaks & damaged components.					
Tires	Check for damaged tires & correct air pressure.					
Seat Belt, Seat Bar & Pedal Interlocks	Check the condition of seat belt. Check the seat bar & pedal interlocks for correct operation. Clean dirt & debris from moving parts.					
Safety Signs & Safety Tread	Check for damaged signs (decals) & safety tread. Replace any signs or safety treads that are damaged or worn.					
Operator Cab	Check the fastening bolts, washers & nuts. Check the condition of cab.					
Fuel Filter	Remove the trapped water.					
Hyd. Fluid, Hoses & Tubelines	Check fluid level & add as needed. Check for damage & leaks. Repair & replace as needed.					
Final Drive Trans. (Chaincase)	Check oil level.					
Battery	Check cables, connections & electrolyte level. Add distilled water as needed.					
Control Pedals & Steering	Check for correct operation. Repair or adjust as needed.					
Wheel Nuts	<input type="checkbox"/> Check for loose wheel nuts & tighten to 105-115 ft.-lbs. (142-156 Nm) torque.					
Parking Brake	Check operation & adjust as needed.					
Alternator Belt	Check tension & adjust as needed.					
Engine Oil & Filter	Replace oil & filter.					
Spark Arrestor Muffler	Clean the spark chamber.					
Engine/Hydro. Drive Belt	* Check for wear or damage. Make adjustment as needed.					
Fuel Filter	Replace filter element.					
Seat Bar	Grease pivots as needed.					
Steering Shaft	Grease two fittings.					
Hyd./Hydro. Filter	● Replace the filter element.					
Hyd. Reservoir Breather Cap	Replace the reservoir breather cap.					
Fan Drive Gearbox	Check gear lube level.					
Final Drive Trans.	Replace the oil in the chaincase.					
Hyd. Reservoir	Replace the fluid.					
Hydraulic Motors	† Replace the case drain filters.					

Check wheel nut torque every 8 hours for the first 24 hours.

● Also replace hydraulic/hydrostatic filter element when the transmission warning light comes ON.

■ Or every 12 months.

\* Inspect the new belt after first 50 hours.

† Clean or replace case drain filters in the event of any major hydraulic or hydrostatic repair.

## LIFT ARM SUPPORT DEVICE



# WARNING

Never work on a machine with the lift arms up unless the lift arms are secured by a lift arm support device. Failure to use an approved lift arm support device can allow the lift arms or attachment to fall and cause injury or death.

W-2059-0991

### To Engage Lift Arm Support Device

Maintenance and service work can be done with the lift arms lowered. If the lift arms are raised use the following procedure:

Put jackstands under the rear corners of the loader.

Disconnect the spring from the lift arm support device retaining pin and remove the retaining pin [A].

Lower the lift arm support device on top of the lift cylinder. Hook the free end of the spring to the lift arm support device so there will be no interference with the support device engagement.

With the operator in the seat, seat belt fastened and seat bar lowered, start the engine.

Raise the lift arms, until the lift arm support device drops onto the lift cylinder rod [C].

Lower the lift arms slowly until the support device is held between the lift arms and the lift cylinder. Stop the engine. Raise the seat bar and move the pedals until both pedals lock.

Install pin (Item 1) [C] into the rear of the lift arm support device below the cylinder rod.

### To Disengage Lift Arm Support Device

Remove the pin from the lift arm support device.

Connect the spring from the lift arm support device to the bracket below the lift arms [D].

With the operator in the seat, seat belt fastened and seat bar lowered, start the engine.

Raise the lift arms a small amount and the spring will lift the support device off the cylinder rod. Lower the lift arms. Stop the engine.

Raise the seat bar and move pedals until both pedals lock.

Disconnect the spring from the bracket.

Raise the support device into storage position and insert pin through lift arm support device and bracket [A].

Connect spring to pin [A].

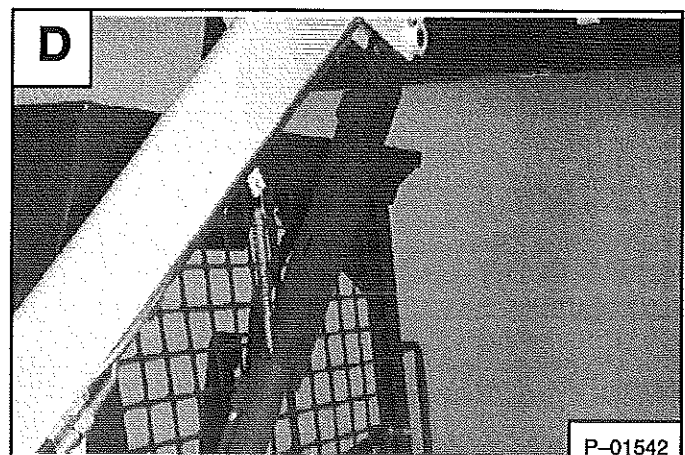
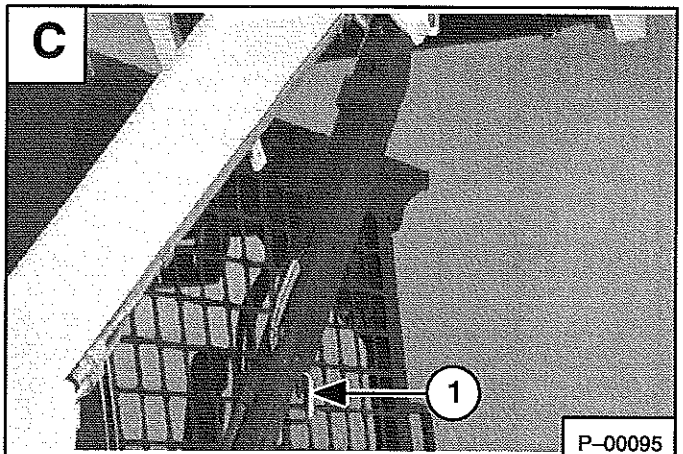
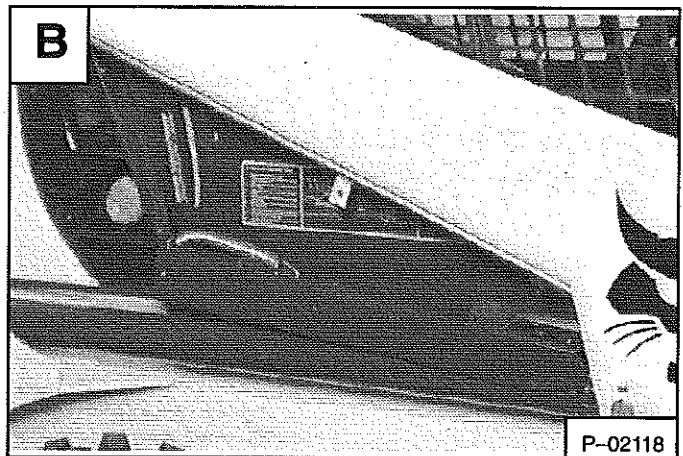
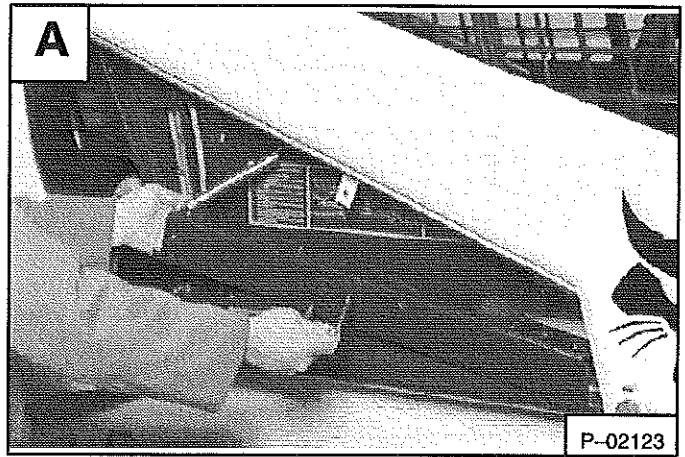



## OPERATOR CAB

The Bobcat loader has an operator cab (ROPS and FOPS) as standard equipment to protect the operator from rollover and falling objects. Check with the dealer if the operator cab has been damaged.

### **WARNING**

Never modify operator cab by welding, grinding, drilling holes or adding attachments unless instructed to do so by Melroe Company. Changes to the cab can cause loss of operator protection from rollover and falling objects, and result in injury or death.

W-2069-1285

### Raising The Operator Cab

Stop the loader on a level surface. Lower the lift arms. If the lift arms must be up while raising the operator cab, install the lift arm support device. (See *LIFT ARM SUPPORT DEVICE* Page 30.)

### **WARNING**

Before the cab or the lift arms are raised for service, jackstands must be put under the rear corners of the frame. Failure to use jackstands can allow the machine to tip backward causing injury or death.

W-2014-0895

Loosen the nut (both sides) at the front corner of the operator cab [A].

Remove the nut and plate (both sides) [B].

Lift on the grab handles and bottom of the operator cab slowly until the cab latching mechanism engages and the cab is all the way up [C].

### Lowering The Operator Cab

**NOTE:** Make sure the seat bar is fully raised or lowered when lowering the cab. Use the grab handles to lower the cab.

Pull down on the bottom of the operator cab until it stops on the latching mechanism. Release the latching mechanism (Item 1) [D] and pull the cab all the way down.

Install the plate and nut (both sides). Tighten the nuts to 40–50 ft.-lbs. (54–69 Nm) torque [A].

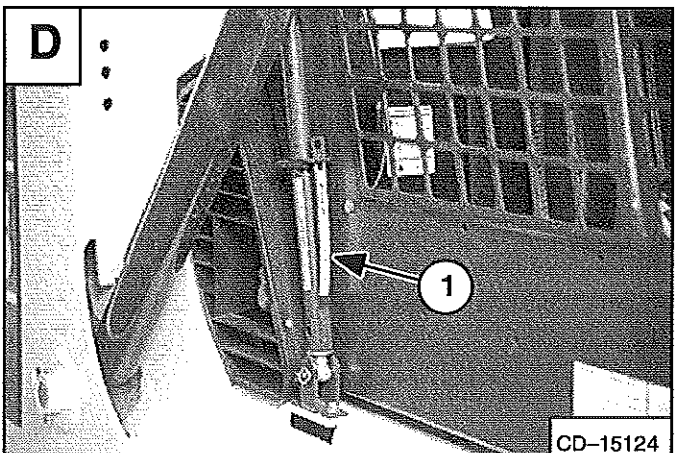
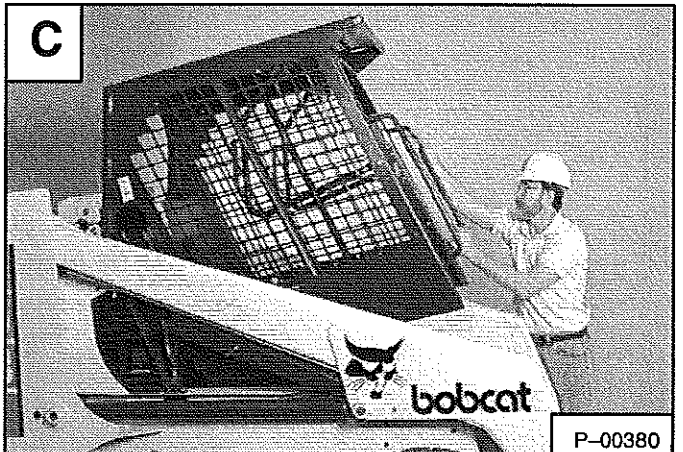
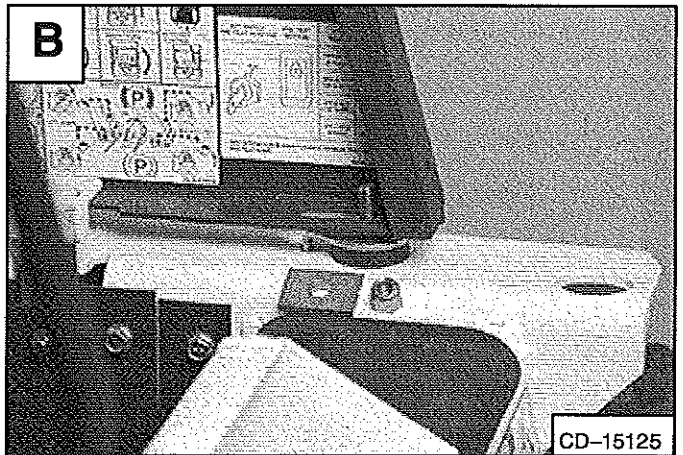
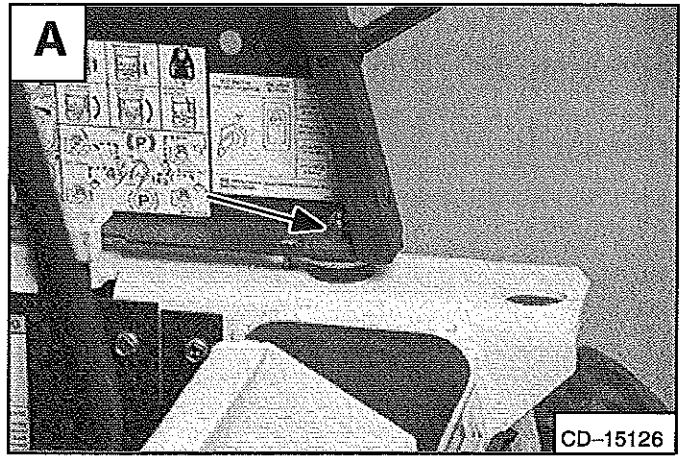

## OPERATOR CAB (Cont'd)

### Emergency Exit

The front opening on the operator cab and rear window provide exits.

To exit through the rear window, use the following procedure:

Pull on the tag at the rear window to remove the rubber cord [A].

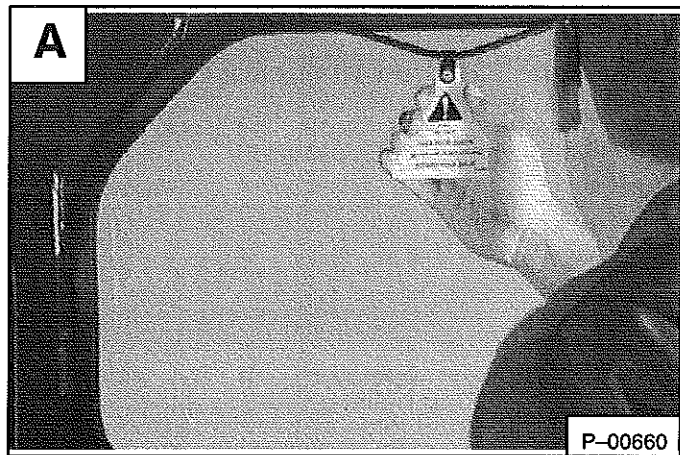

Push the rear window out of the rear of the operator cab.

Exit through the rear of the operator cab [B].

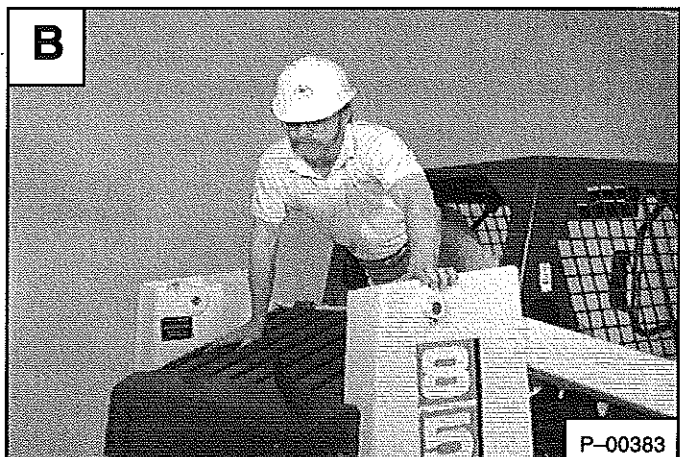



## SEAT BAR RESTRAINT SYSTEM

The seat bar restraint system has pivoting seat bar with arm rests and has spring loaded interlocks for the lift and tilt control pedals. The operator controls the use of the seat bar. The seat bar in the down position helps keep the operator in the seat. The interlocks require the operator to lower the seat bar in order to operate the foot pedal controls. When the seat bar is up, the lift and tilt pedals are locked when returned to the neutral position.

### **WARNING**

#### **AVOID INJURY OR DEATH**

The seat bar system must lock the lift and tilt control pedals in neutral when the seat bar is up. Service the system if pedals do not lock correctly.

W-2105-1285

#### **Seat Bar Inspection**

Sit in the seat and fasten the seat belt. Engage the parking brake. Pull the seat bar all the way down. Start the engine. Operate each foot pedal to check both the lift and tilt functions. Raise the lift arms until the bucket is about 2 feet (600 mm) off the ground.

Raise the seat bar. Try to move each foot pedal. Pedals must be firmly locked in neutral position. There must be no motion of the lift arms or tilt (bucket) when the pedals are pushed.

Pull the seat bar down, lower the lift arms and place the bucket flat on the ground. Stop the engine. Raise the seat bar and operate the foot pedals to be sure that the pedals are firmly locked in the neutral position. Unbuckle the seat belt.

### **WARNING**

#### **AVOID INJURY OR DEATH**

Never operate loader without pedal lock shield 6705474 on both interlocks. Shields prevent foot from unlocking interlocks when leaving loader seat.

W-2162-1194

#### **Seat Bar Maintenance**

See the *SERVICE SCHEDULE* Page 29 and on the loader for correct service interval.

Clean any debris or dirt from the moving parts [A] & [B]. Inspect the linkage bolts and nuts for tightness. The correct torque is 25–28 ft.-lbs. (34–38 Nm).

Use a general purpose grease to lubricate the seat bar pivot points at each side of the cab [A]. If the seat bar system does not function correctly, check for free movement of each linkage part. Check for excessive wear. Adjust pedal control linkage. Replace parts that are worn or damaged. Use only genuine Melroe replacement parts.

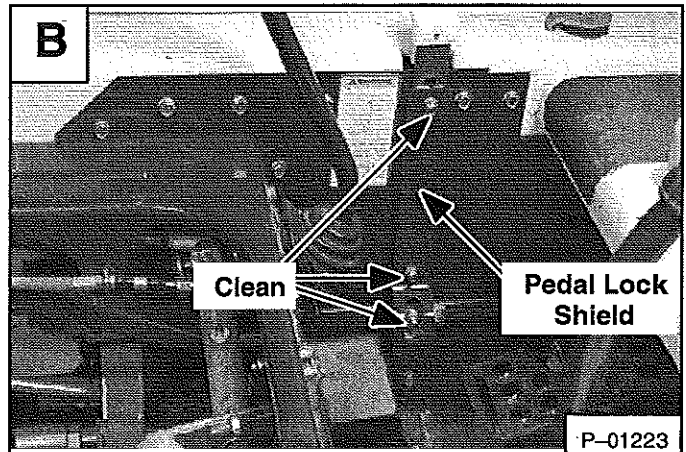
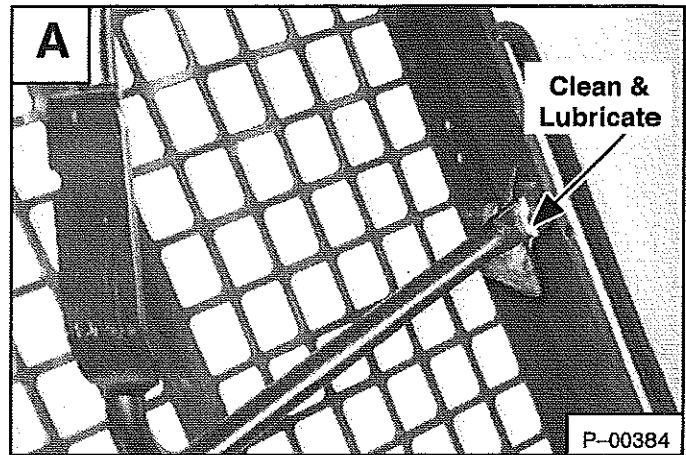

## REAR DOOR

### **WARNING**

#### **AVOID INJURY OR DEATH**

Never service or adjust the machine when the engine is running unless instructed to do so in the manual.

W-2012-0497

To open the rear door, use the following procedure:

Put your fingers into the slot in the rear door and pull on the latch handle inside (Inset) [A].

Pull the rear door open.

### **WARNING**

Keep the rear door closed when operating the machine. Failure to do so could seriously injure a bystander.

W-2020-1285

## Adjustment

The door latch can be adjusted up or down for alignment with the door latch mechanism.

## REAR GRILL

To open the rear grill, use the following procedure:

Open the rear door.

Raise the rear grill [B].

The rear grill is held open by the cylinder (Item 1) [C].

**NOTE:** To prevent damage to the rear grill, always lower the rear grill before raising the operator cab.

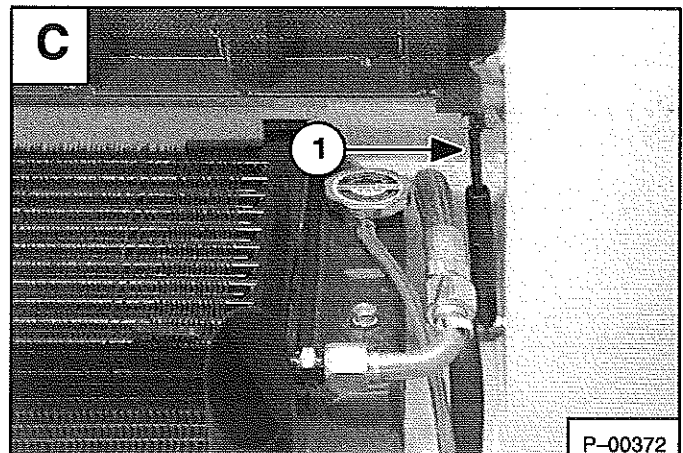
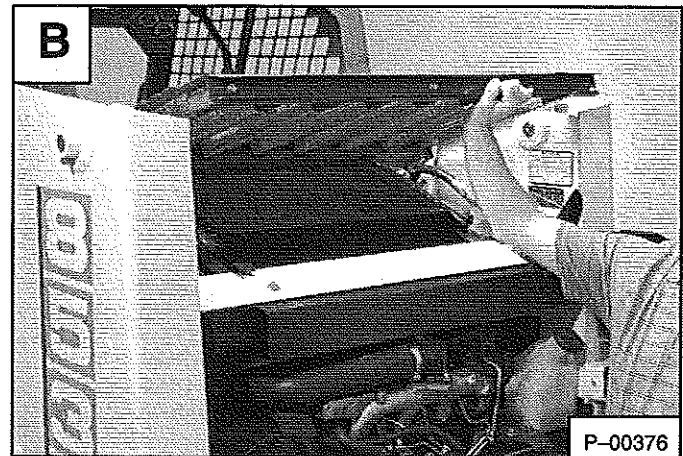
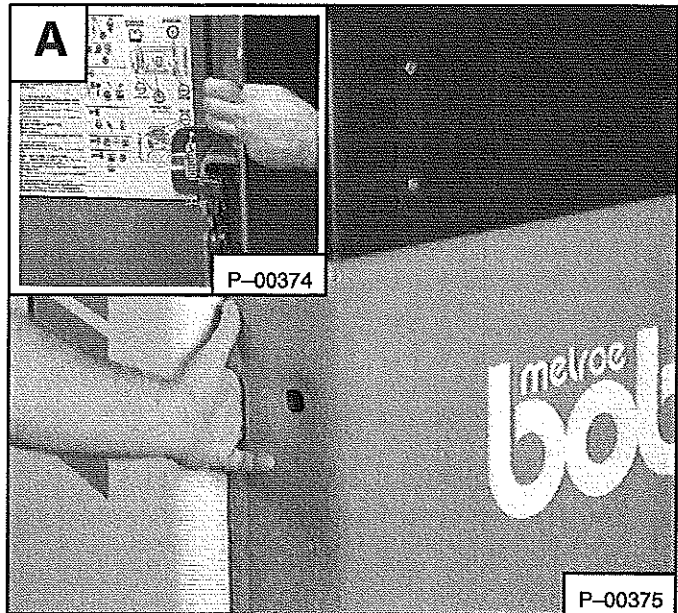



## AIR CLEANER SERVICE (Cont'd)

### Servicing The Air Cleaner (Cont'd)

Remove the wing nut at the large air filter element [A].

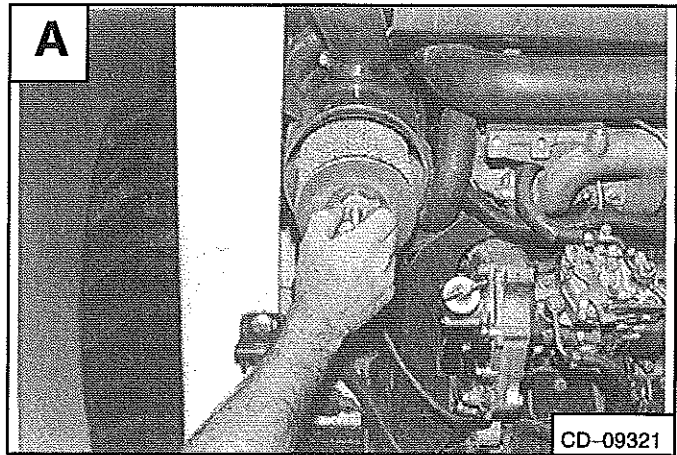

Remove the large filter element [B].

**NOTE:** Make sure all sealing surfaces are free of dirt and debris.

Install the new filter element and tighten the wing nut. Install the dust cover and tighten the wing nut.

**NOTE:** Make sure the evacuator is in the down position.

Check the air intake hose for damage. Check the air cleaner housing for damage. Check to make sure all connections are tight.

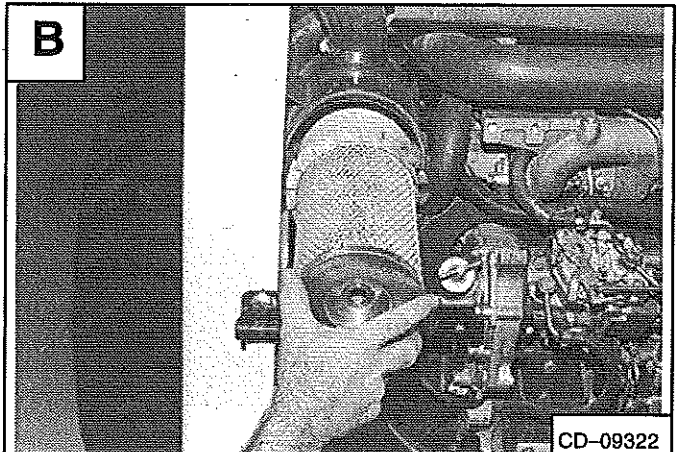

Only replace the inner filter element under the following conditions [C]:

1. Replace the inner filter element every third time the outer filter is replaced.
2. Replace the inner filter element when the service codes show symbols **AF.2**, only after the outer filter element has been changed and the engine speed is at full RPM.

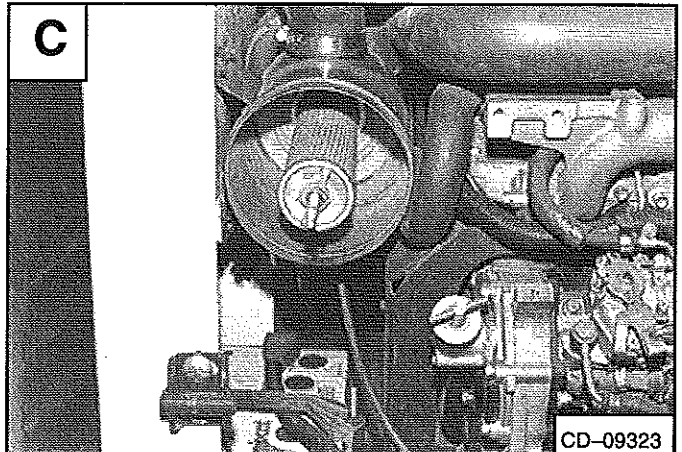



## FUEL SYSTEM

### Fuel Specifications

Use only clean, high quality fuel. Use Grade No. 2 fuel above 40° F (4° C). Use Grade No. 1 fuel at temperatures below 40° F (4° C).

### Filling The Fuel Tank

# ⚠ WARNING

Stop and cool the engine before adding fuel. **NO SMOKING!** Failure to obey warnings can cause an explosion or fire.

W-2063-0887

Remove the fuel fill cap (Item 1) [A].

Use a clean, approved safety container to add fuel of the correct specifications. Add fuel only in an area that has free movement of air and no open flames or sparks. **NO SMOKING!** [B].

Install and tighten the fuel fill cap [A].

### Fuel Filter

# ⚠ WARNING

Always clean up spilled fuel or oil. Keep heat, flames, sparks or lighted tobacco away from fuel and oil. Failure to use care around combustibles can cause explosion or fire which can result in injury or death.

W-2103-1285

See the *SERVICE SCHEDULE* Page 29 for the service interval when to remove water from the fuel filter.

Loosen the drain at the bottom of the filter element to drain the water from the filter [C].

See the *SERVICE SCHEDULE* Page 29 for the service interval when to replace the fuel filter.

Use a filter wrench to remove the filter element [D].

Clean the area around the filter housing. Put oil on the seal of the new filter element. Install the fuel filter, hand tighten the filter element.

Remove the air from the fuel system. (See *Removing Air From The Fuel System* Page 38.)

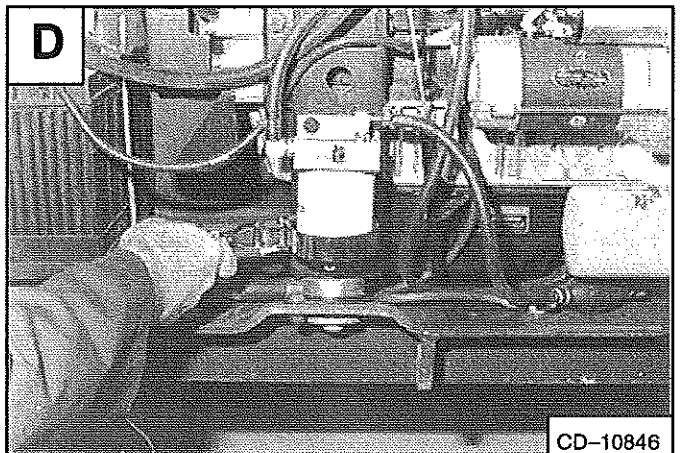
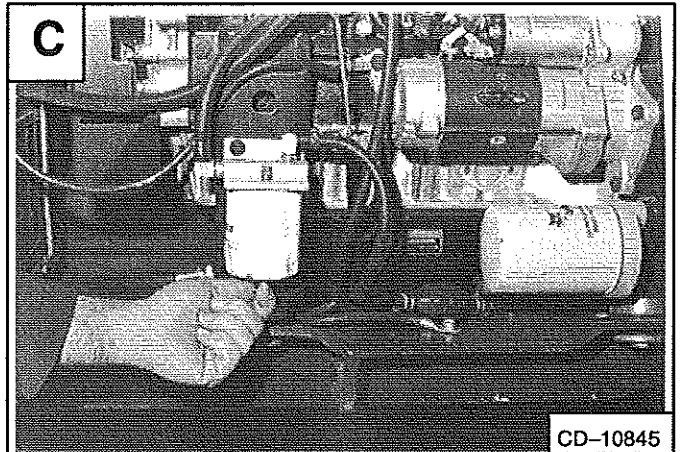
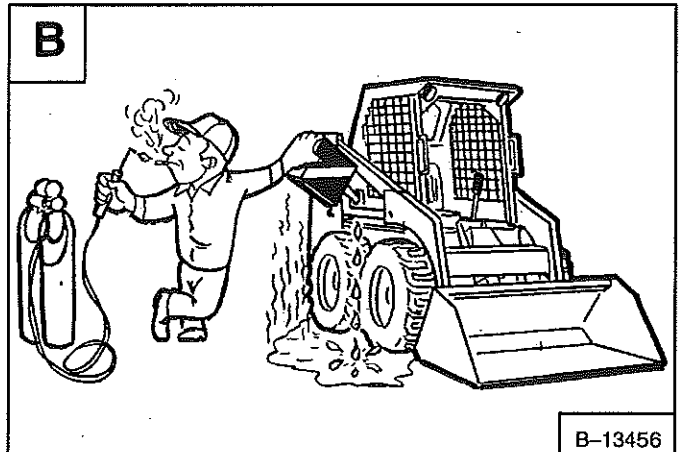
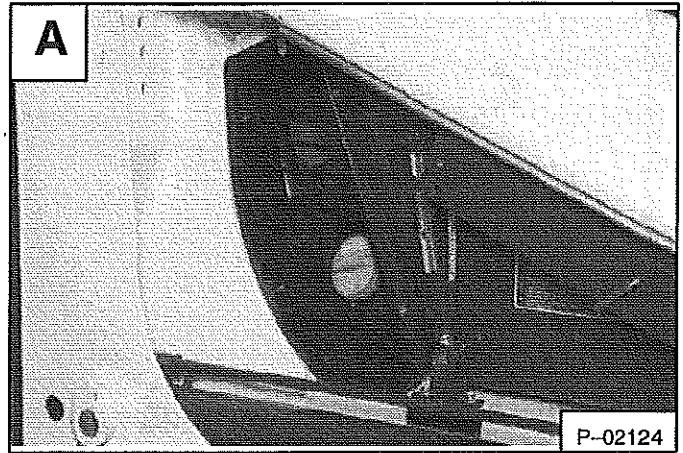

## FUEL SYSTEM (Cont'd)

### Removing Air From The Fuel System

After replacing the fuel filter element or when the tank has run out of fuel, the air must be removed from the fuel system to start the engine

Loosen the air vent plug at the top of the fuel filter [A].

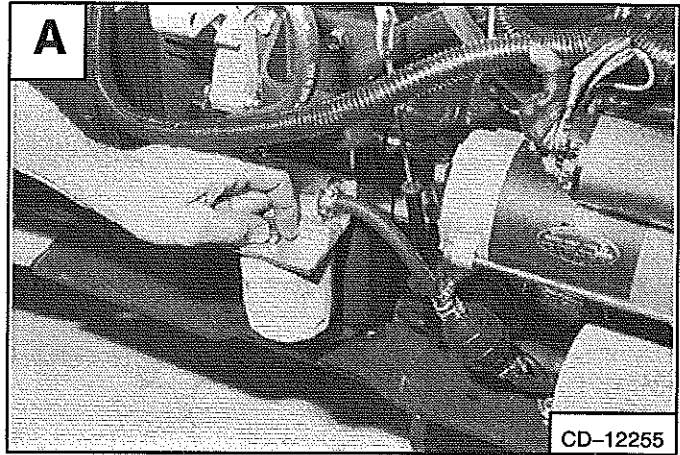

Operate the priming bulb until fuel flows from the filter vent plug [B]. Tighten the fuel filter vent plug.

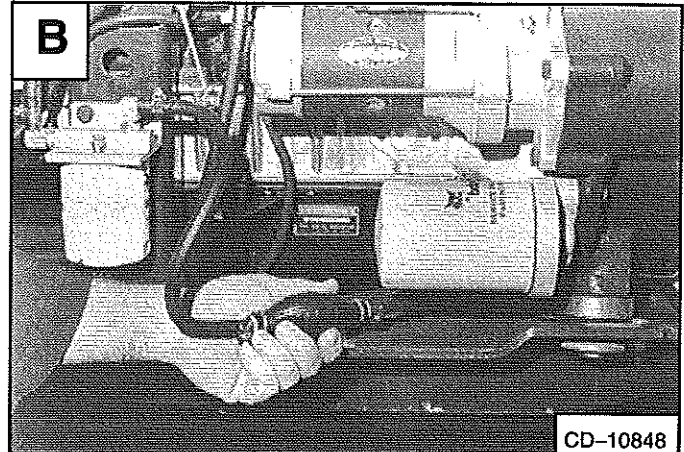

Loosen the air vent plug at the top of the fuel injection pump [C].

Again operate the priming bulb until fuel flows from the air vent plug with no air bubbles showing [B].

Tighten the air vent plug at the fuel injection pump [C].

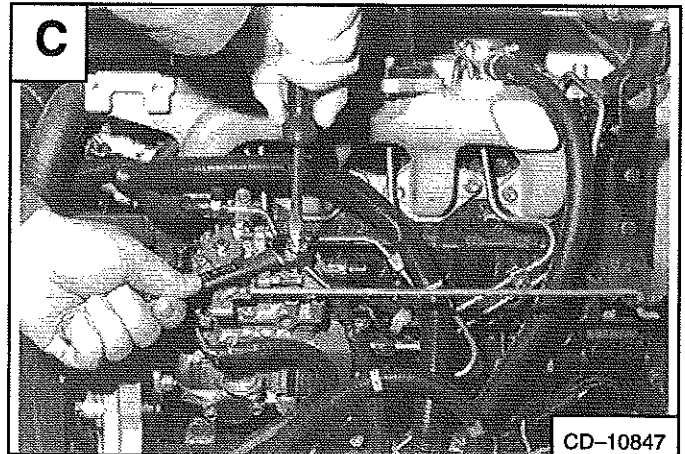

## WARNING

Always clean up spilled fuel or oil. Keep heat, flames, sparks or lighted tobacco away from fuel and oil. Failure to use care around combustibles can cause explosion or fire which can result in injury or death.

W-2103-1285

## ENGINE LUBRICATION SYSTEM

### Checking Engine Oil

Check the oil level every day.

Before starting the engine for the work shift, open the rear door remove the dipstick [A].

Keep the oil level between the marks on the dipstick.

Use a good quality motor oil that meets API Service Classification of CC, CD or CE (See Oil Chart Below).

### RECOMMENDED SAE VISCOSITY NUMBER (LUBRICATION OILS FOR ENGINE CRANKCASE)

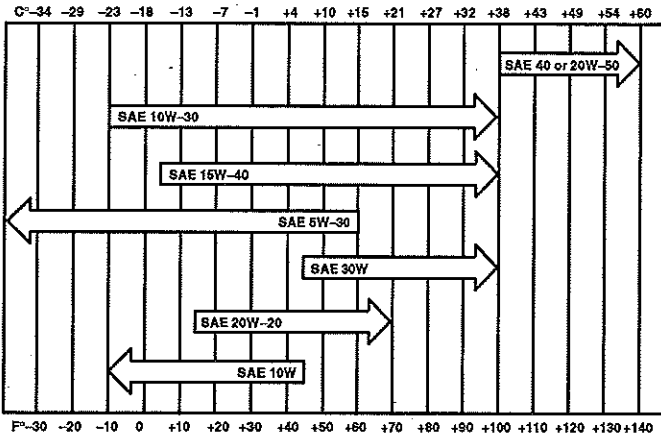

TEMPERATURE RANGE ANTICIPATED BEFORE  
NEXT OIL CHANGE  
DIESEL: USE API CLASSIFICATION CC, CD or SE)

### Replacing Oil And Filter

See the *SERVICE SCHEDULE* Page 29 for the service interval for replacing the engine oil and filter.

Run the engine until it is at operating temperature. Stop the engine.

Open the rear door. Remove the drain plug [B]. Drain the oil into a container.

Remove the oil filter [C].

Clean the filter housing surface. Put clean oil on the oil filter gasket. Install the filter and hand tighten only.

Install and tighten the drain plug.

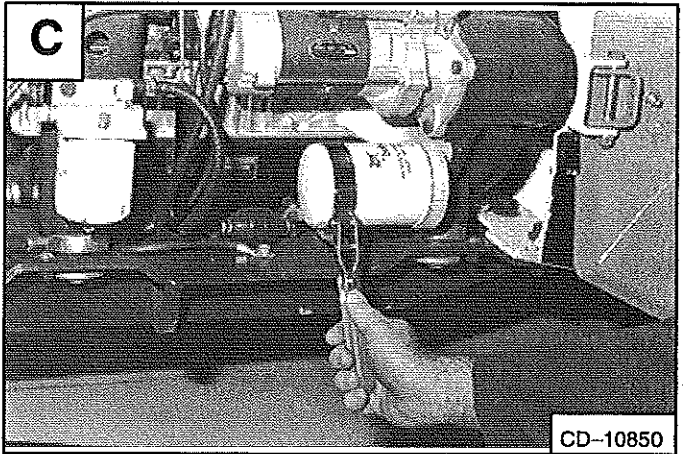
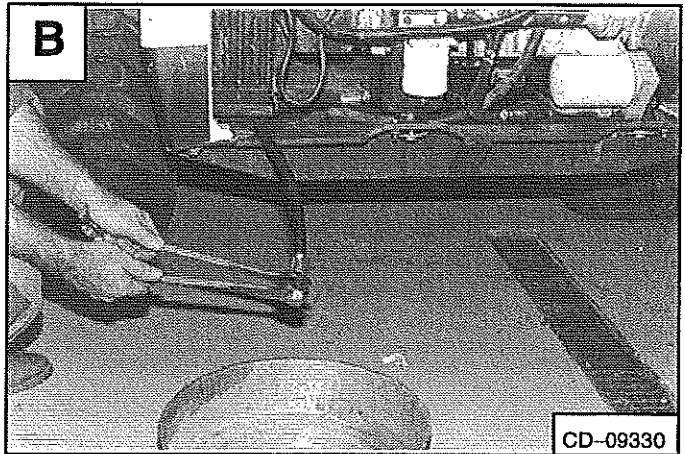
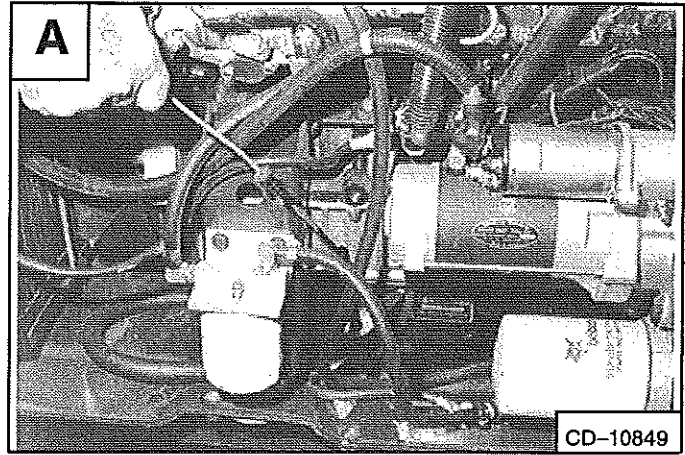

## ENGINE LUBRICATION SYSTEM (Cont'd)

### Replacing Oil And Filter (Cont'd)

Remove the filler cap [A].

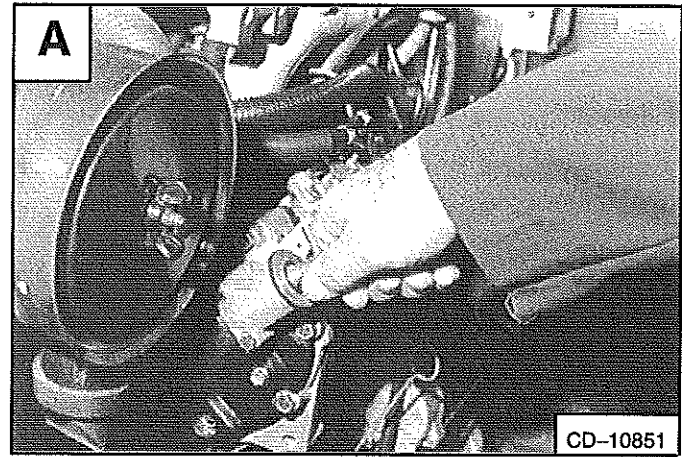

Put 8 qts. (7,6 L) of oil in the engine [B]. (See *Checking Engine Oil* Page 39.)

Start the engine and let it run for several minutes. Stop the engine. Check for leaks and check the oil level. Add oil as needed if not at the top mark on the dipstick.

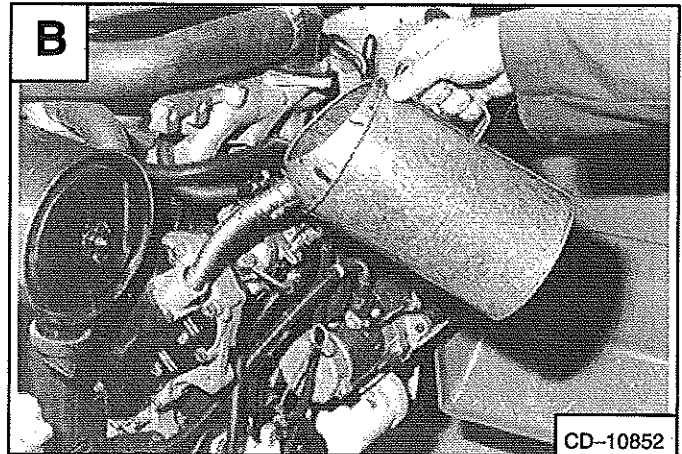

## **WARNING**

Always clean up spilled fuel or oil. Keep heat, flames, sparks or lighted tobacco away from fuel and oil. Failure to use care around combustibles can cause explosion or fire which can result in injury or death.

W-2103-1285



## COOLING SYSTEM

Check the cooling system every day to prevent overheating, loss of performance or engine damage.



# WARNING

Wear safety glasses to prevent eye injury when any of the following conditions exist:

- When fluids are under pressure.
- Flying debris or loose material is present.
- Engine is running.
- Tools are being used.

W-2019-1285

### Cleaning The Cooling System

Raise the rear grill.

Use air pressure or water pressure to clean the top of the oil cooler [A].

Raise the oil cooler and clean on the top of the radiator [B].

Check cooling system for leaks.

### Checking The Coolant Level

Open the rear door. Check the coolant level in the coolant recovery tank on the right side of the engine [C].

The coolant recovery tank must be 1/3 full (engine cold).

Add premixed coolant, 50% water and 50% ethylene glycol to the recovery tank if the coolant level is low.

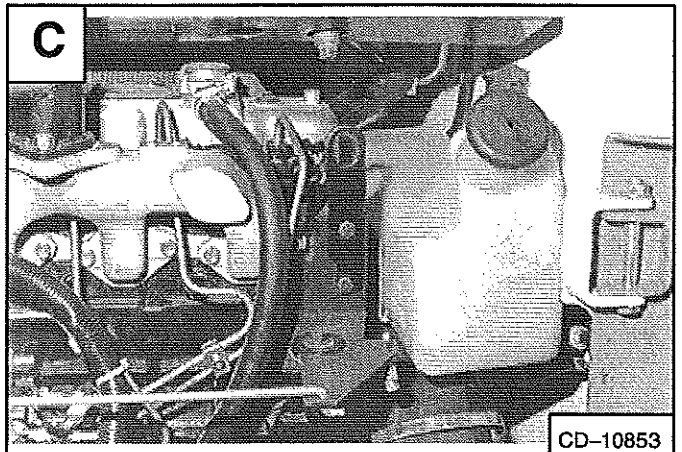
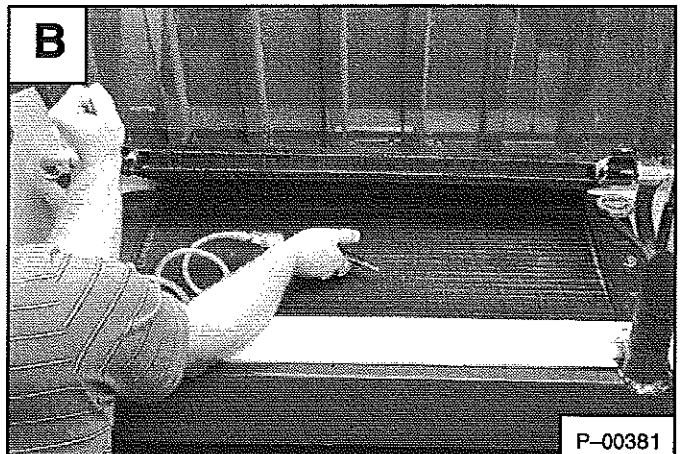
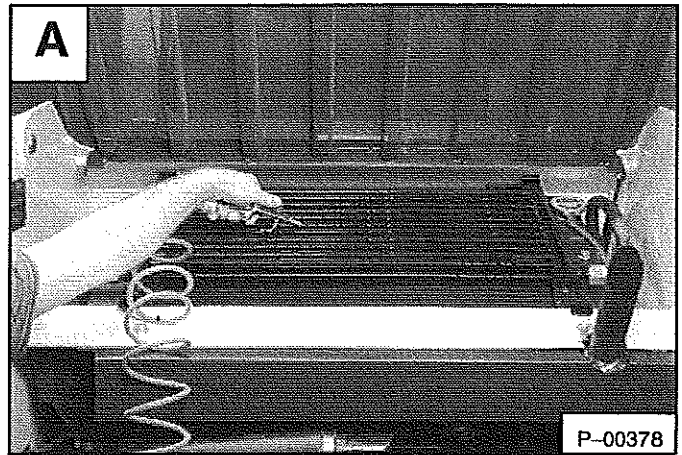

## COOLING SYSTEM (Cont'd)

### Removing Coolant From The Cooling System

# **WARNING**

Do not remove radiator cap when the engine is hot. You can be seriously burned.

W-2070-1285

Open the rear door. Open the rear grill.

Remove the radiator cap (Item 1) [A].

Connect the drain plug from the side of the engine block [B] drain the coolant into a container.

After the coolant is removed, install and tighten the drain plug.

**NOTE: The loader is factory filled with propylene glycol coolant. DO NOT mix propylene glycol with ethylene glycol.**

### Propylene Glycol

Add premixed coolant, 47% water and 53% propylene glycol to the recovery tank if the coolant level is low.

One gallon and one pint of propylene glycol mixed with one gallon of water is the correct mixture of coolant to provide a  $-34^{\circ}\text{F}$  ( $-37^{\circ}\text{C}$ ) freeze protection.

Use a refractometer to check the condition of propylene glycol in your cooling system.

Mix the coolant in separate container. (See *SPECIFICATIONS* Page 71 for correct capacity.)

Fill the radiator and engine block with the premixed coolant. Install the radiator cap.

Fill the coolant recovery tank 1/3 full.

Run the engine until it is at operating temperature. Stop the engine. Check the coolant level in the recovery tank when cool. Add coolant to the recovery tank as needed.

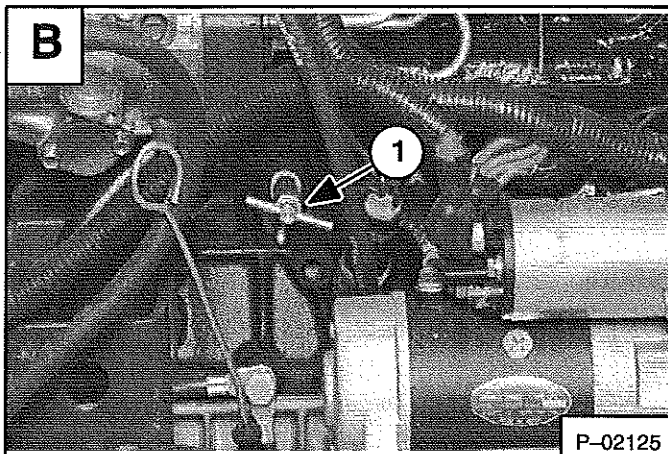
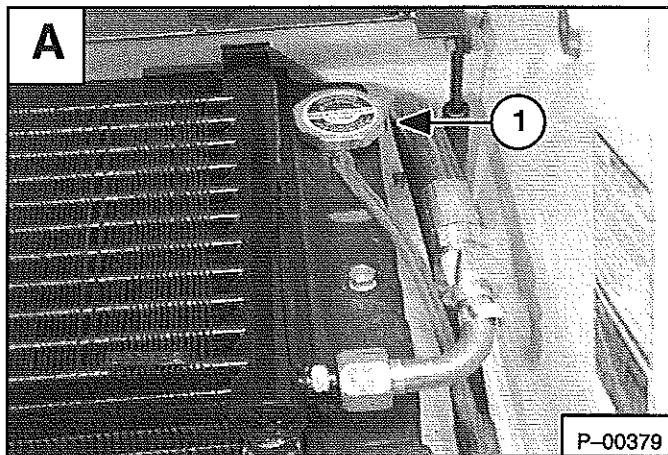

## ALTERNATOR BELT

### Adjusting The Alternator Belt

To adjust the belt tension for the alternator, use the following procedure:

Stop the engine.

Raise the operator cab. (See *Raising The Operator Cab* Page 31.)

Loosen the alternator mounting bolt (Item 1) [A].

Loosen the adjustment bolt (Item 2) [A].

Move the alternator until the belt has 5/16 inch (8,0 mm) movement at the middle of the belt span with 15 lbs. (66 N) force.

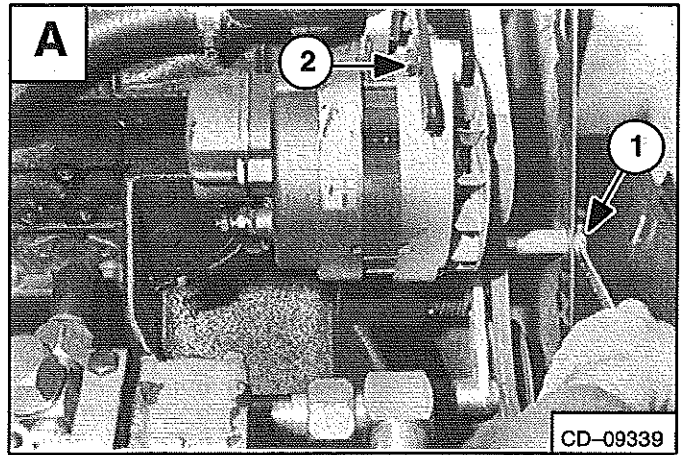

## ELECTRICAL SYSTEM

### Description

The loader has a 12 volt, negative ground alternator charging system. The electrical system is protected by fuses located in the instrument panel or the engine compartment. The fuses will protect the electrical system when there is an electrical overload. The reason for the overload must be found before starting the machine again.

### Servicing The Electrical System

The battery cables must be clean and tight. Check the water level in the battery. Remove any acid or corrosion from the battery and cables with a sodium bicarbonate and water solution [A].

Cover the battery terminals and cable ends with grease.

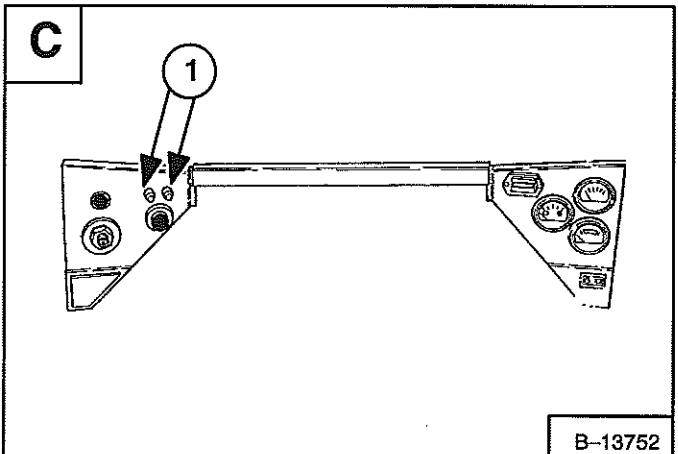
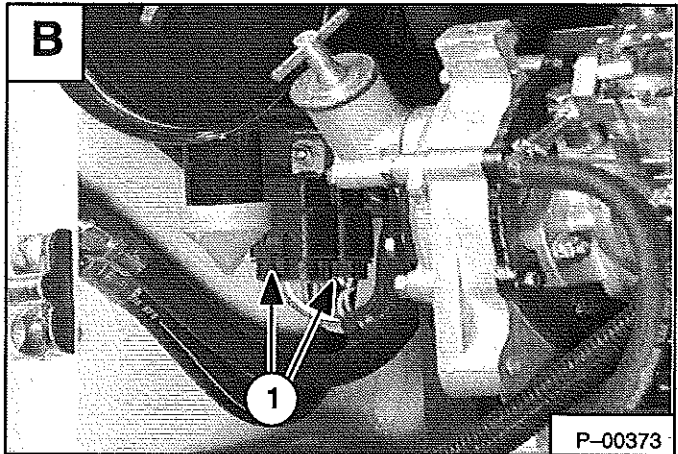
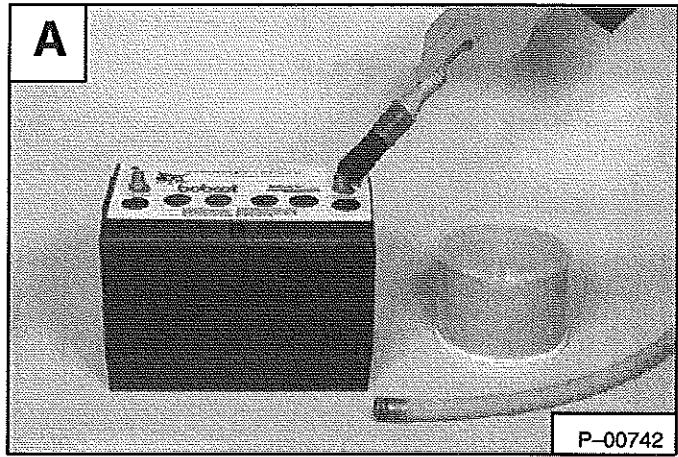

## WARNING

Batteries contain acid which burns eyes and skin on contact. Wear goggles, protective clothing and rubber gloves to keep acid off body.

In case of acid contact, wash immediately with water. In case of eye contact get prompt medical attention and wash eye with clean, cool water for at least 15 minutes.

If electrolyte is taken internally drink large quantities of water or milk! DO NOT induce vomiting. Get prompt medical attention.

W-2065-1296

### Fuse Location – 853 (Optional) & 853H (Option)

The electrical system for loaders is protected by two fuses (Item 1) [B] installed in the wiring harness. Fuses protect the electrical system from an overload. The fuses are located in the engine compartment under the air cleaner.

### Fuse Location – 853 (Standard)

The electrical system for this model loader is protected by two fuses (Item 1) [C] located in the instrument panel.

## ELECTRICAL SYSTEM

### Using A Booster Battery (Jump Starting)

# ⚠ WARNING

Keep arcs, sparks, flames and lighted tobacco away from batteries. When *jumping* from booster battery make final connection (negative) at engine frame.

Do not jump start or charge a frozen or damaged battery. Warm battery to 60°F. (16°C.) before connecting to a charger. Unplug charger before connecting or disconnecting cables to battery. Never lean over battery while boosting, testing or charging.

Battery gas can explode and cause serious injury.

W-2066-1296

If it is necessary to use a booster battery to start the engine, BE CAREFUL! There must be one person in the operator's seat and one person to connect and disconnect the battery cables.

The ignition must be in the OFF position. The booster battery use must be 12 volt.

Connect the end of the first cable (Item 1) [A] to the positive (+) terminal of the booster battery. Connect the other end of the same cable (Item 2) to the starter.

Connect the end of the second cable (Item 3) [A] to the negative (-) terminal of the booster battery. Connect the other end of the same cable (Item 4) [A] to the engine.

Keep cables away from moving parts. Start the engine. (See *STARTING THE ENGINE* Page 15.)

After the engine has started, remove the ground (-) cable (Item 4) [A] first.

Remove the cable from the starter.

# IMPORTANT

Damage to the alternator can occur if:

- Engine is operated with battery cables disconnected.
- Battery cables are connected when using a fast charger or when welding on the loader (Remove both cables from the battery).
- Extra battery cables (booster cables) are connected wrong.

I-2023-1285

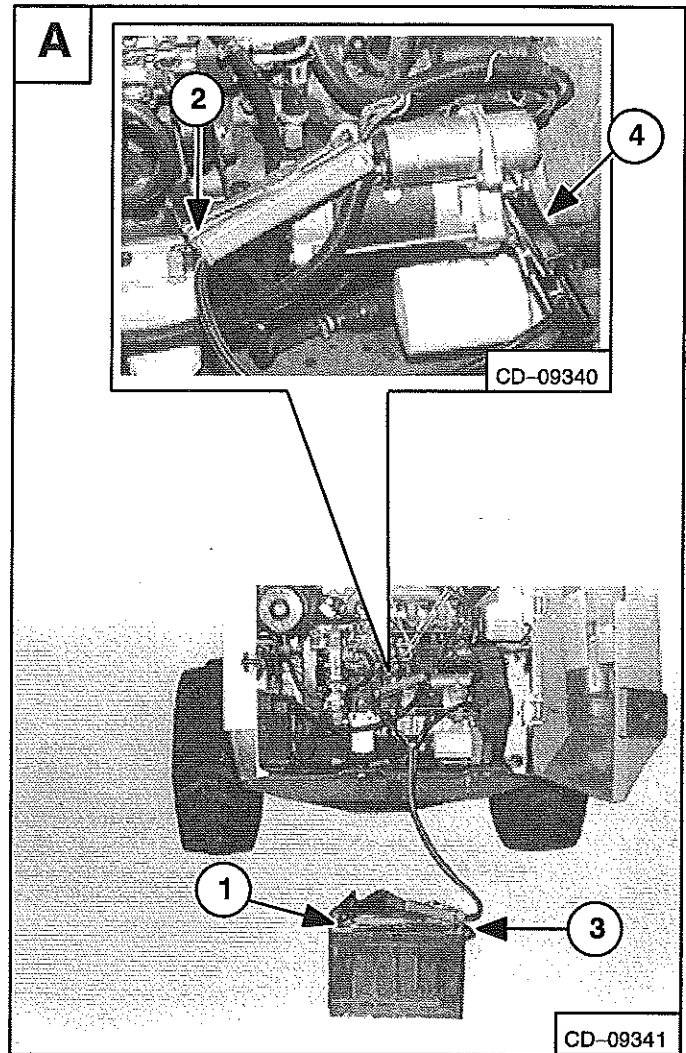



## ELECTRICAL SYSTEM (Cont'd)

### Battery Removal And Installation

Open the rear door. Disconnect the negative (-) battery cable [A].

Disconnect the positive (+) battery cable (Item 1) [A].

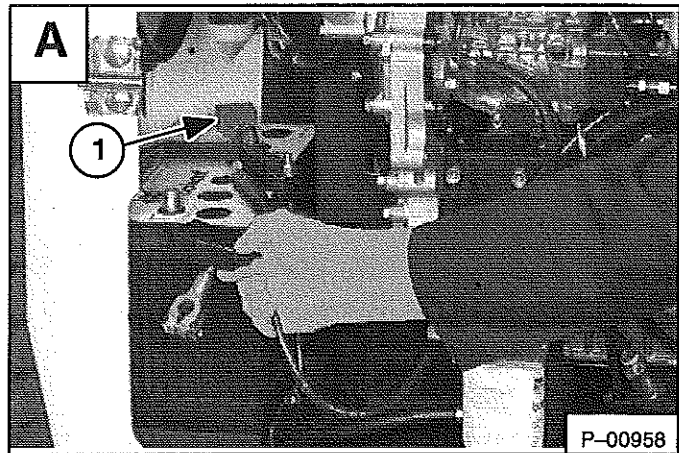

Remove the battery holddown clamp [B].

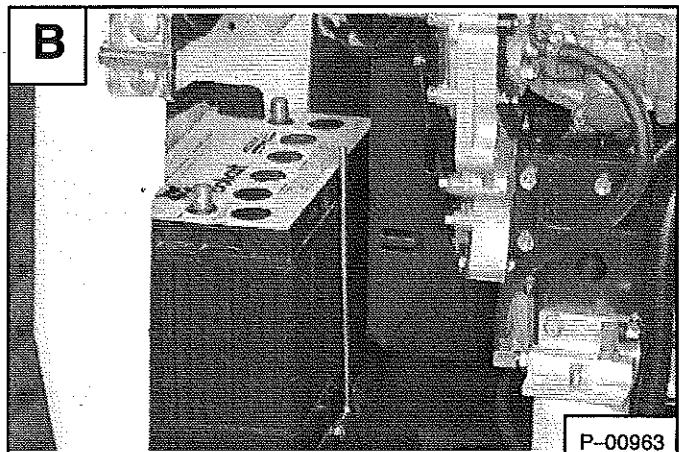

Remove the battery from the loader [C].

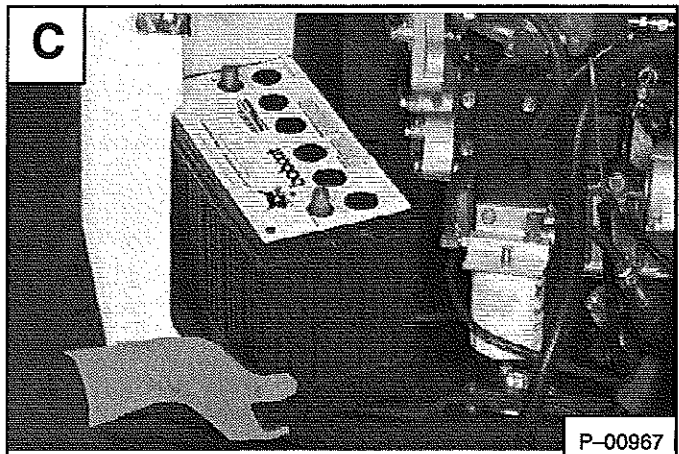

Always clean the terminals and cable ends when installing a new battery [D].

When installing the battery in the loader, do not touch any metal parts with the battery terminal posts.

Connect and tighten the battery cables. Connect the negative (-) cable last to prevent sparks.

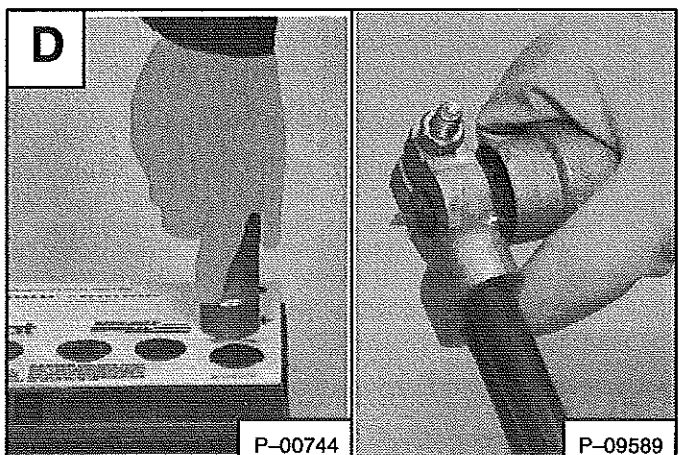

## HYDRAULIC/HYDROSTATIC SYSTEM

### Checking And Adding Fluid

Use only recommended fluid in the hydraulic system. (See *SPECIFICATIONS* Page 71 for the correct fluid.)

To check the reservoir use the following procedures:

Put the Bobcat loader on a level surface. Lower the lift arms and tilt the Bob-Tach fully back.

Remove the dipstick [A].

The fluid level must be between the marks on the dipstick.

The fluid is needed, remove the fill cap [B].

**NOTE:** Before installing the fill cap, make sure the rubber gasket is installed on the fill cap (Inset) [B].

Add the fluid as needed to bring the level to the top mark on the dipstick. [C].

### Hydraulic/Hydrostatic Filter Replacement

See the *SERVICE SCHEDULE* Page 29 for the correct service interval.

Raise the operator cab. (See *Raising The Operator Cab* Page 31.)

Use a filter wrench and remove both filter elements (Items 1 & 2) [D].

Clean the surface of the filter housing where the element seal contacts the housing. Put clean oil on the rubber seal of the filter elements.

Install and tighten the filter elements.

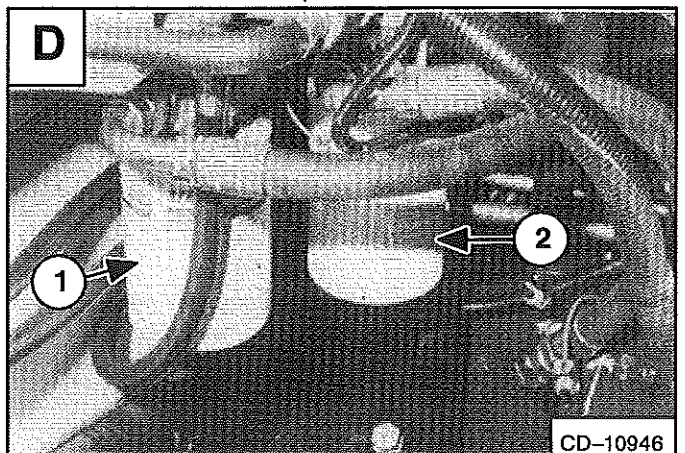
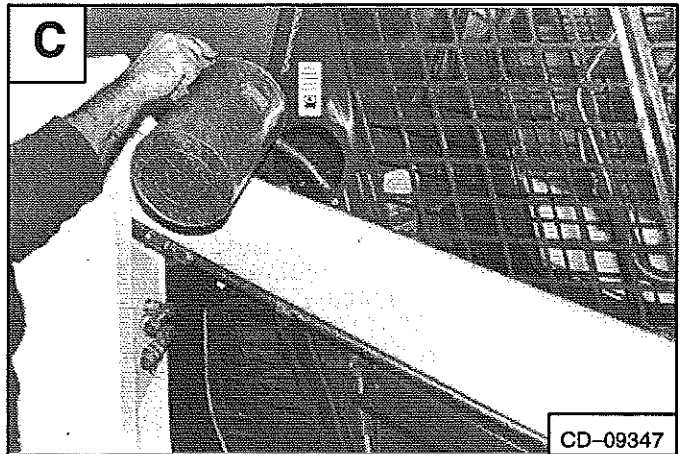
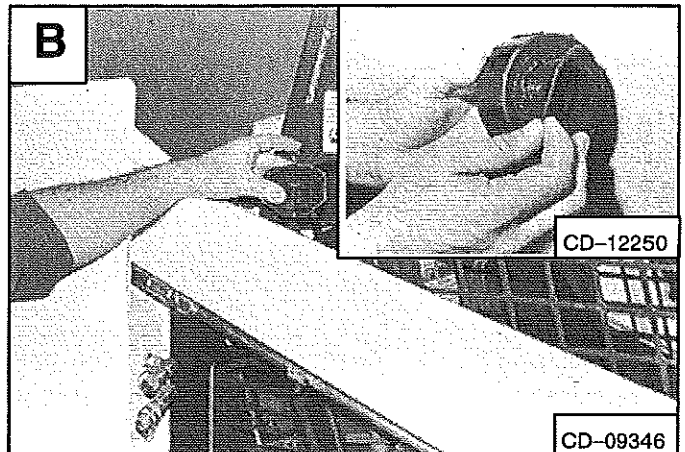
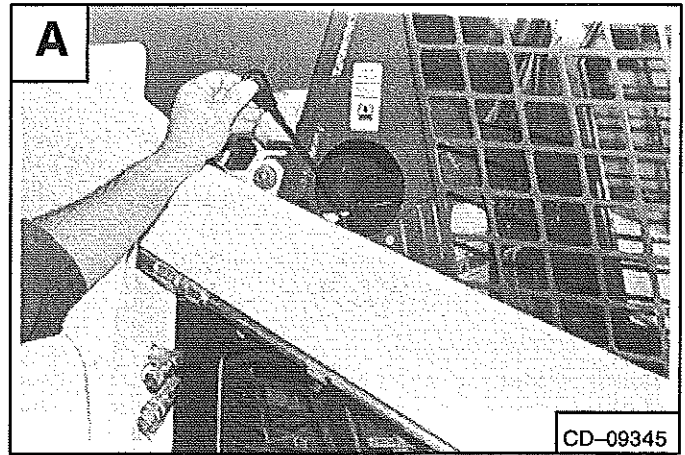



## HYDRAULIC/HYDROSTATIC SYSTEM (Cont'd)

### Hydraulic Fluid Replacement

See the *SERVICE SCHEDULE* Page 29 for the correct service interval.

Replace the fluid after it becomes contaminated or after major repair.

Clean the two hydrostatic motor case drain filters thoroughly after a major repair.

Remove the fill cap [A].

**NOTE:** Before installing the fill cap, make sure the rubber gasket is installed on the fill cap (Inset) [A].

Raise the operator cab. (See *Raising The Operator Cab* Page 31.)

Disconnect the hose from the hydrostatic motor case drain filter (Item 1) [B].

**NOTE:** There is a 90 micron filter in each hydrostatic motor case drain line.

Remove the case drain filters (Item 1) [B] and clean thoroughly from both hydrostatic motors.

When all the fluid is removed from the reservoir, connect and tighten the filters and case drain hoses.

Add the correct fluid to the reservoir until the fluid level is between the marks on the dipstick. Do not fill above the top mark on the dipstick.

## **⚠ WARNING**

Diesel fuel or hydraulic fluid under pressure can penetrate skin or eyes, causing serious injury or death. Fluid leaks under pressure may not be visible. Use a piece of cardboard or wood to find leaks. Do not use your bare hand. Wear safety goggles. If fluid enters skin or eyes, get immediate medical attention from a physician familiar with this injury.

W-2072-0496

Always clean up spilled fuel or oil. Keep heat, flames, sparks or lighted tobacco away from fuel and oil. Failure to use care around combustibles can cause explosion or fire which can result in injury or death.

W-2103-1285

Lower the operator cab. Start the engine and operate the loader hydraulic controls. Stop the engine. Check for leaks. Check the fluid level in the reservoir and add as needed.

### Hydraulic Reservoir Breather Cap

See the *SERVICE SCHEDULE* Page 29 for the correct service interval.

Remove the breather cap and replace it with a new cap [C].

**NOTE:** Make sure the rubber gasket is installed on the breather cap (Inset) [C].

Make sure the baffle washer is installed in the hydraulic reservoir [D].

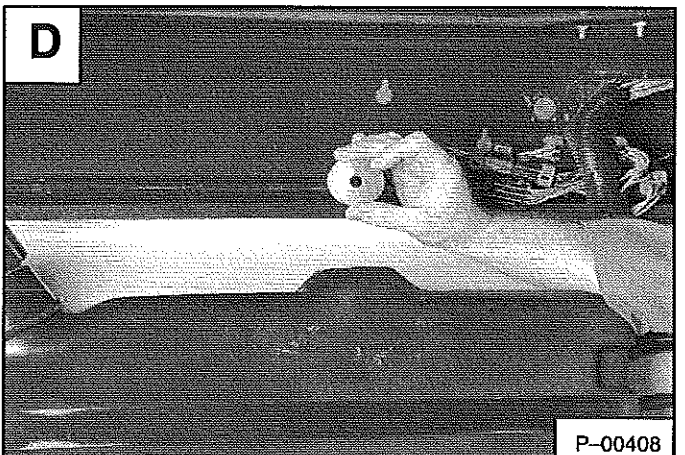
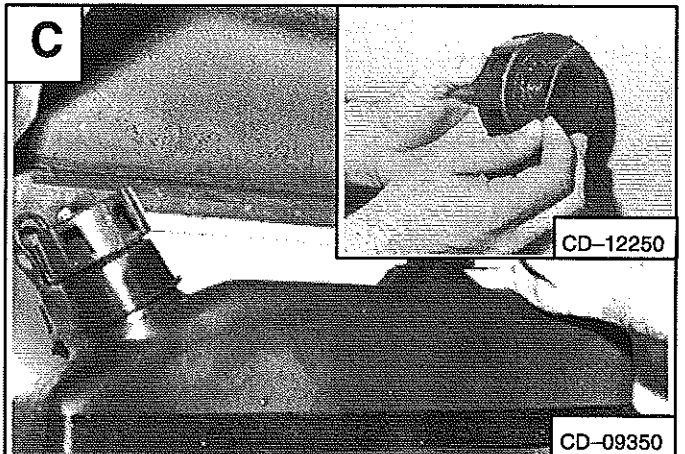
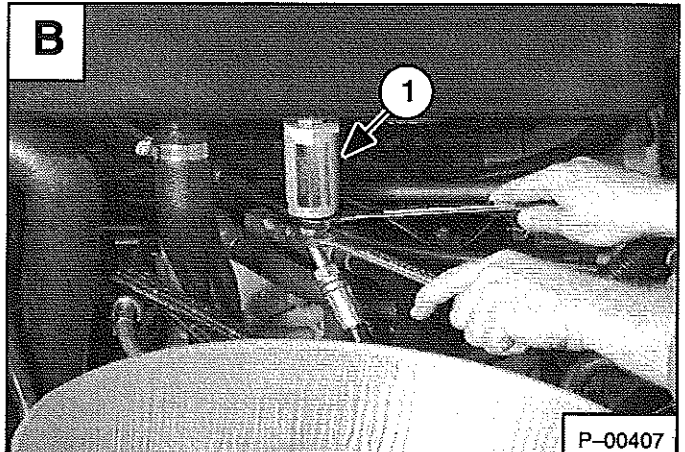
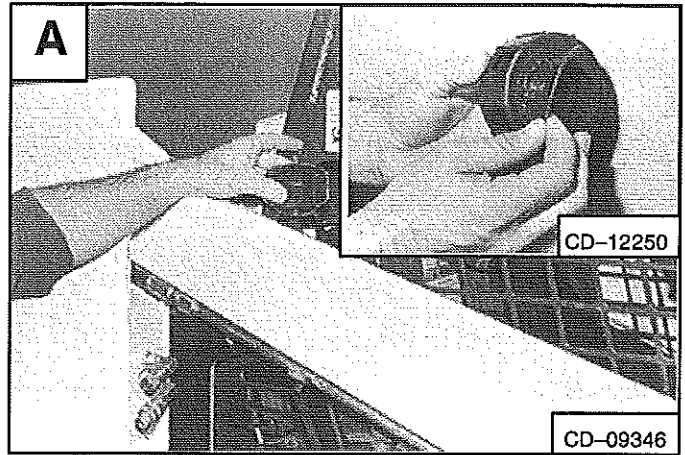

## SPARK ARRESTOR MUFFLER

See the *SERVICE SCHEDULE* Page 29 for the service interval for cleaning the spark arrestor muffler.

Do not operate the loader with a defective exhaust system.

### IMPORTANT

This loader is factory equipped with a U.S.D.A. Forestry Service approved spark arrestor muffler. It is necessary to do maintenance on this spark arrestor muffler to keep it in working condition. The spark arrestor muffler must be serviced by dumping the spark chamber every 100 hours of operation.

If this machine is operated on flammable forest, brush or grass covered land, it must be equipped with a spark arrestor attached to the exhaust system and maintained in working order. Failure to do so will be in violation of California State Law, Section 4442 PRC.

Make reference to local laws and regulations for spark arrestor requirements.

I-2022-0595

Stop the engine. Open the rear door and raise the rear grill.

Remove the plug (Item 1) [A] from the bottom of the muffler.

### ! WARNING

When the engine is running during service, the steering levers must be in neutral and the parking brake engaged. Failure to do so can cause injury or death.

W-2006-0284

Start the engine and run for about 10 seconds while a second person, wearing safety glasses, holds a piece of wood over the outlet of the muffler.

Stop the engine. Install and tighten the plug.

Lower the rear grill and close the rear door.

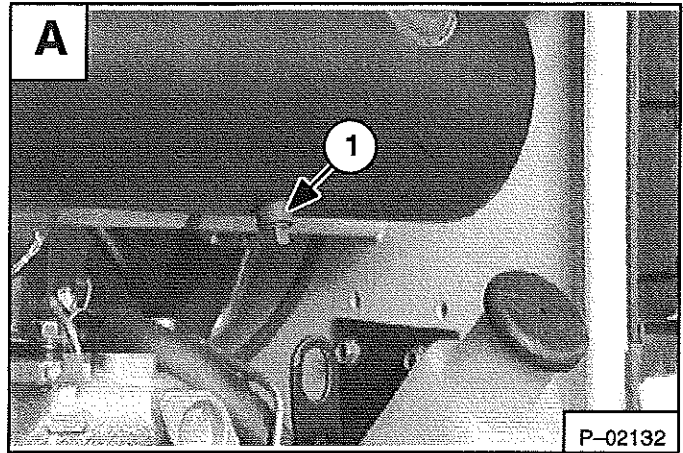

P-02132

### ! WARNING

When an engine is running in an enclosed area, fresh air must be added to avoid concentration of exhaust fumes. If the engine is stationary, vent the exhaust outside. Exhaust fumes contain odorless, invisible gases which can kill without warning.

W-2050-1285

Stop engine and allow the muffler to cool before cleaning the spark chamber. Wear safety glasses or goggles. Failure to obey can cause serious injury.

W-2011-1285

Never use machine in atmosphere with explosive dust or gases or where exhaust can contact flammable material. Failure to obey warnings can cause injury or death.

W-2068-1285

## TIRE MAINTENANCE

### Wheel Nuts

See the *SERVICE SCHEDULE* Page 29 for the service interval to check the wheel nuts. The correct torque is 105–115 ft.-lbs. (142–156 Nm) [A].

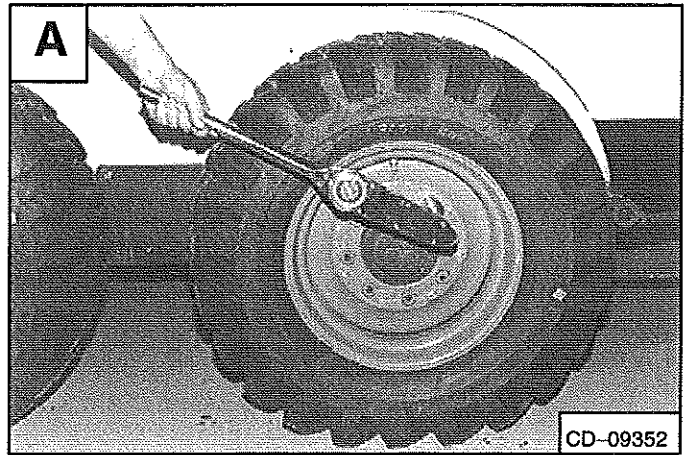

### Tire Rotation

Check the tires regularly for wear, damage and pressure. (See *SPECIFICATIONS* Page 71 for the correct tire pressure.)

Rear tires usually wear faster than front tires. To keep the tire wear even, move the front tires to the rear and the rear tires to the front [B].

It is important to keep the same size tires on each side of the loader to avoid excessive wear. If different sizes are used, each tire will be turning at a different rate and cause excessive wear. When tires wear, install two new tires on the same side of the loader. The tread bars of all the tires must face the same direction.

Recommended tire pressure must be maintained to avoid excessive tire wear and loss of stability and handling capability. Check for correct pressure before operating the loader.

### Tire Mounting

Tires are to be repaired only by an authorized person using the proper procedures and safety equipment. Tires and rims must always be checked for correct size before mounting. Check rim and tire bead for damage.

The rim flange must be cleaned and free of rust. The tire bead and rim flange must be lubricated with a rubber lubricant before mounting the tire. Avoid excessive pressure which can rupture the tire and cause serious injury or death. During inflation of the tire, check the tire pressure frequently to avoid overinflation.

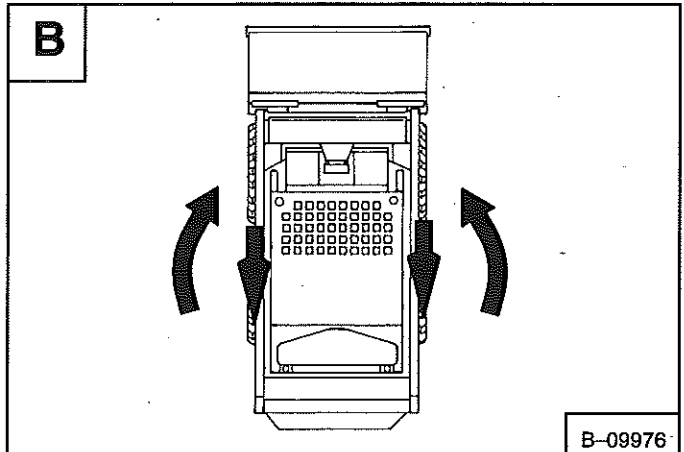

## **WARNING**

Do not inflate tires above specified pressure. Failure to use correct tire mounting procedure can cause an explosion which can result in injury or death.

W-2078-1285

## FINAL DRIVE TRANSMISSION (CHAINCASE)

### Checking And Adding Oil

The chaincase contains the final drive sprockets and chains and uses the same type of oil as the hydraulic/hydrostatic system. (See *SPECIFICATIONS* Page 71.)

To check the chaincase oil level, use the following procedure:

Drive the loader onto a level surface. Stop the engine.

Remove the plug (Item 1) [A] from the front of the chaincase housing.

If oil can be reached with the tip of your finger through the hole the oil level is correct.

If the level is low, add oil through the check plug hole until the oil flows from the hole. Install and tighten the plug.

To drain the oil from the chaincase, remove the drain plug (Item 1) [B] at the rear of the chaincase.

Drain the oil into a container.

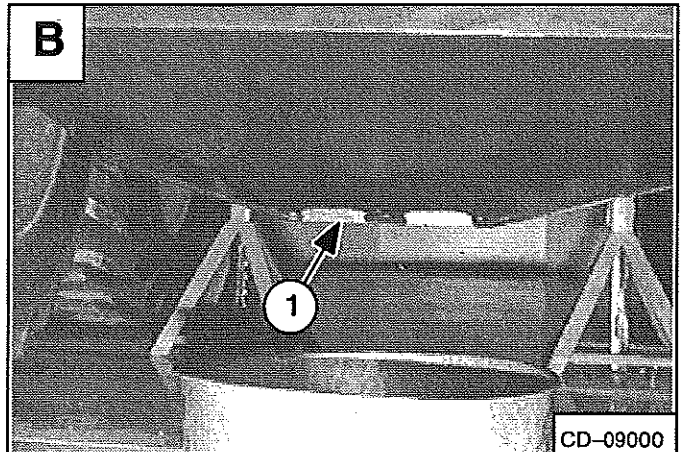
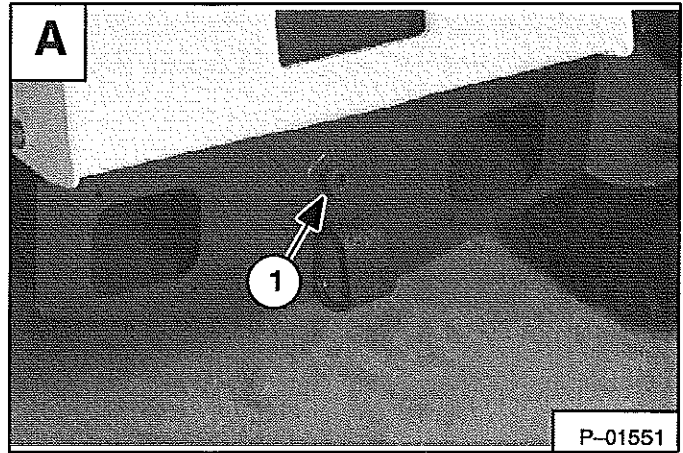

## FAN GEARBOX

See the *SERVICE SCHEDULE* Page 29 for the correct service interval.

Raise the operator cab. (See *Raising The Operator Cab* Page 31.)

Remove the plug (Item 1) [C] to check the lubricant level.

If the level is low, add 90W gear lube through the check plug hole until the lubricant flows from the hole. Install and tighten the plug.

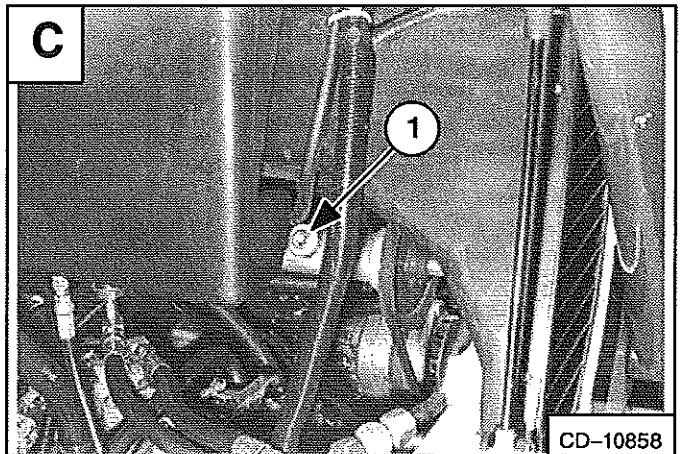



## DRIVE BELT

### Adjustment

See the *SERVICE SCHEDULE* Page 29 for the service interval.

To adjust the drive belt between the engine flywheel and the hydrostatic pump pulley, use the following procedure:

Stop the engine. Open the rear door.

Remove the belt shield holddown clips [A].

Remove the belt shield [B].

Use the following tools to check the belt tension.

MEL1404 – Bar

MEL1406 – Spring Scale

Install the tool on the drive belt. The pin (Item 1) [C] must be pulled tight against the engine drive pulley.

Make a mark (Item 2) [C] on the cast flange just above the tool handle.

Install the spring scale on the tool handle. The line of pull (Item 3) [C] on the spring scale must be approximately 90° from the tool handle.

Loosen bolt (Item 4) [C] and jam nut (Item 5) [C].

Tighten adjustment nut (Item 6) [C] to increase belt tension; loosen to decrease belt tension.

Tighten bolt (Item 4) [C] and jam nut (Item 5) [C].

**NEW BELT:** (Less than .5 hours use): with 14 lbs. (62 N) of force, the tool should move 1.250 inches (32 mm) (the width of the tool handle). Run the engine approximately 5 minutes and readjust the tension.

**USED BELT:** (More than .5 hours use): with 12 lbs. (53 N) of force, the tool should move 1.250 inches (32mm) (the width of the tool handle).

Always readjust if a tension check results in a reading of less than 10 lbs. (44 N) of force.

### Drive Belt Replacement

Stop the engine. Open the rear door.

Raise the operator cab. (See *Raising The Operator Cab* Page 31.)

Remove the belt shield holddown clips [A].

Remove the belt shield [B].

Loosen the belt (Item 1) [C] on the idler pulley tensioner housing.

Remove the belt from the hydrostatic pump pulley and flywheel. Remove the drive belt [D].

Install the new drive belt and adjust. (See *Adjustment* above.)

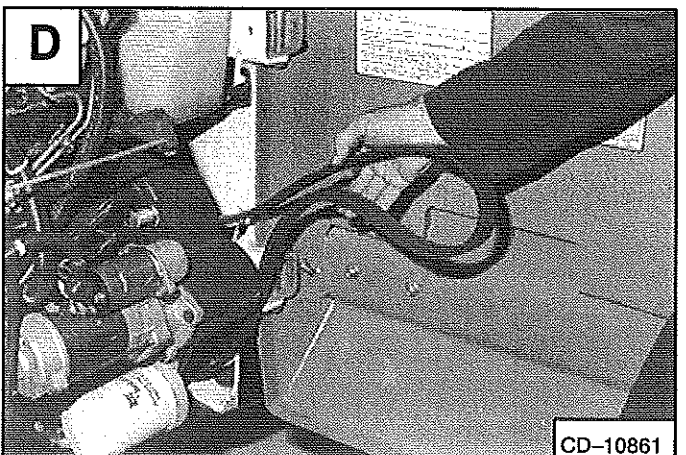
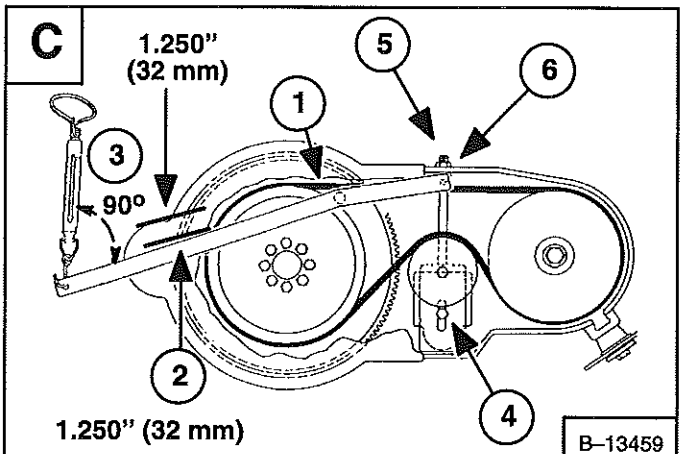
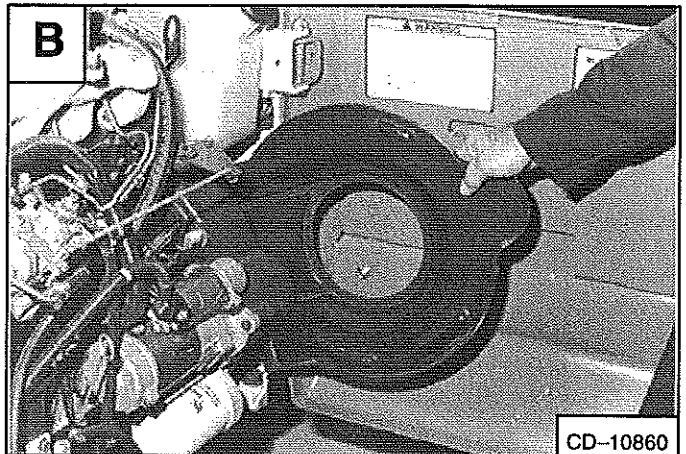
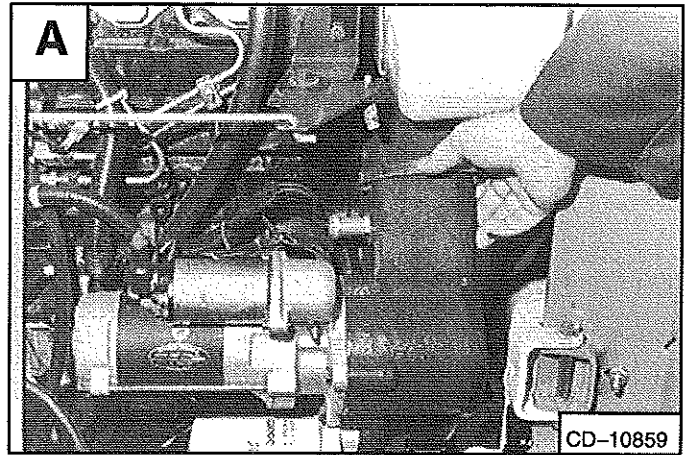

## LUBRICATION OF THE BOBCAT LOADER

Lubricate the loader as specified in the *SERVICE SCHEDULE* in this section for the best performance of the loader.

Record the operating hours each time you lubricate the Bobcat loader.

Always use a good quality lithium based multipurpose grease when you lubricate the loader. Apply the lubricant until extra grease shows.

Lubricate the following locations on the loader: 

1. Rod End Lift Cylinder (Both Sides) [A].

2. Base End Lift Cylinder (Both Sides) [B].

3. Lift Arm Pivot Pin (Both Sides) [C].

4. Base End Tilt Cylinder [D].

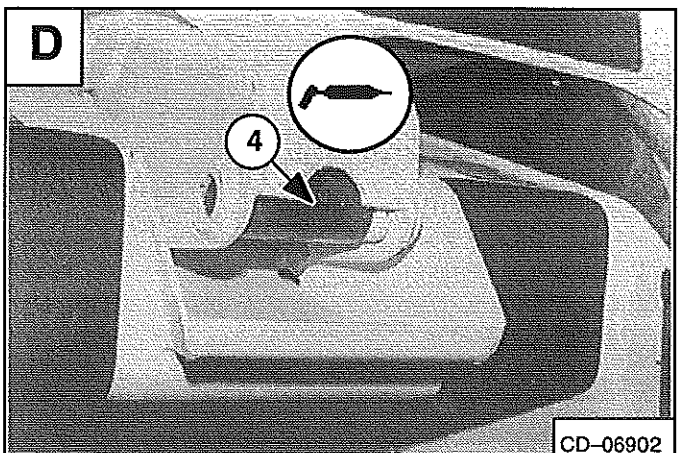
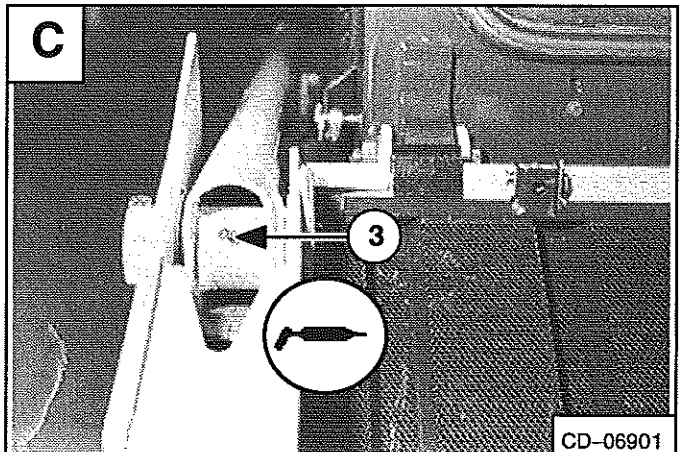
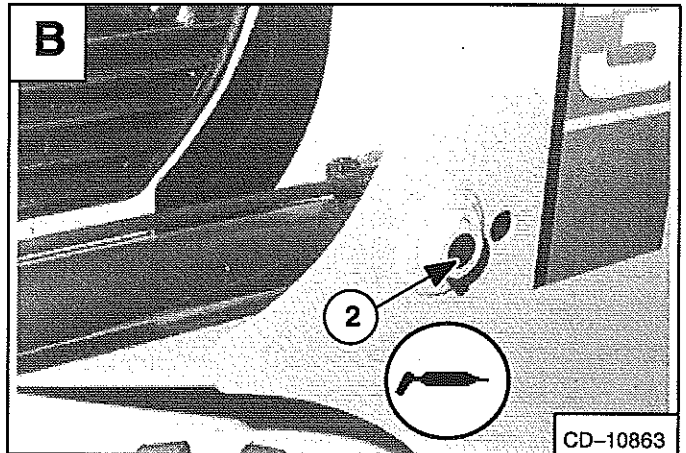
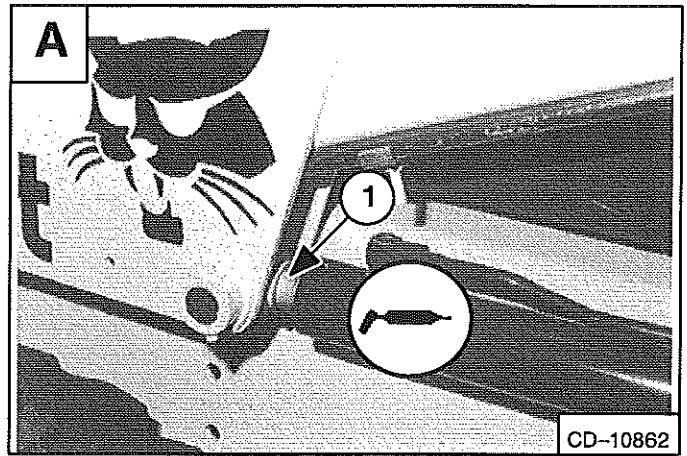



## LUBRICATION OF THE BOBCAT LOADER (Cont'd)

5. Rod End Tilt Cylinder [A].

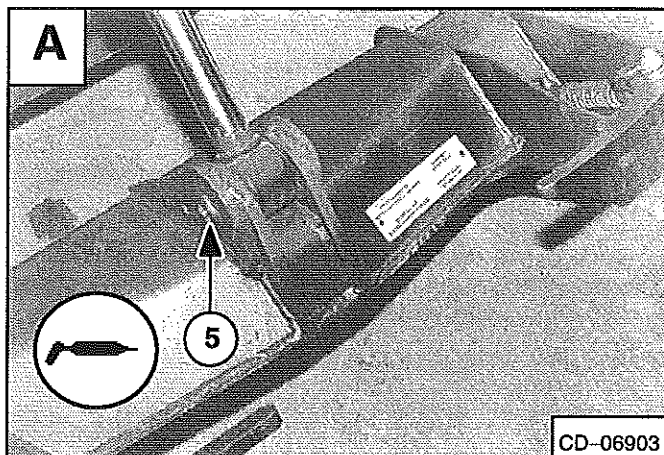

6. Bob-Tach Pivot Pin (Both Sides) [B].

7. Bob-Tach Wedge (Both Sides) [B].

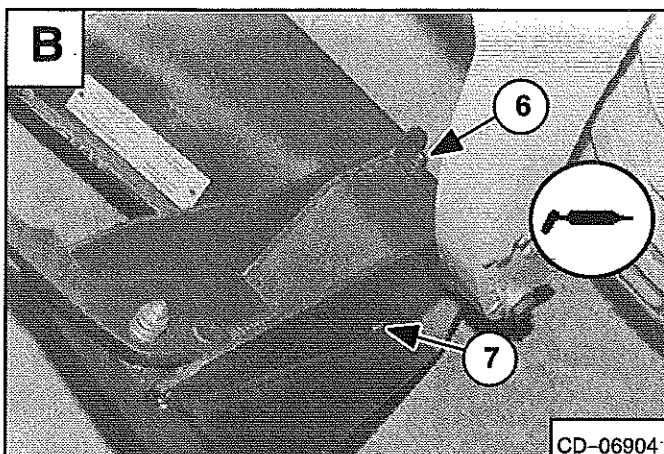

8. 250 Hours: Steering Lever Shaft (2) [C].  
Centering Mechanism (1)

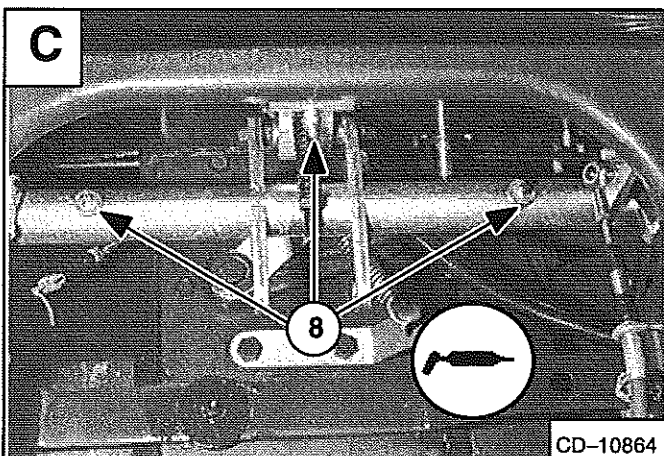

### PIVOT PINS

All lift arm and cylinder pivots have a large pin (Item 1) [D] held in position with a retainer bolt and lock nut.

Check that the lock nuts are tightened to 18–20 ft.-lbs. (24–27 Nm) torque.

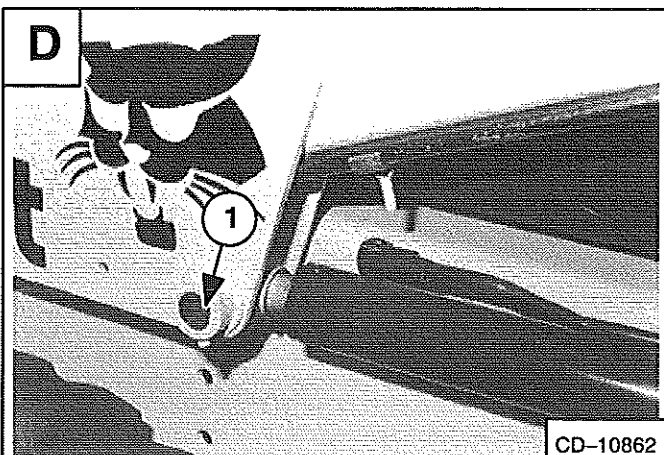

## BOB-TACH

Check for free movement of wedges and Bob-Tach levers.

The wedges (Item 1) [A] must extend far enough to engage the holes in the attachment.

### **WARNING**

Bob-Tach wedges must extend through the holes in attachment. Lever(s) must be fully down and locked. Failure to secure wedges can allow attachment to come off and cause injury or death.

W-2102-0497

Replace wedges that are bent or broken.

## PARKING BRAKE PEDAL

### Adjustment

Raise the operator cab. (See *Raising The Operator Cab* Page 31.)

Loosen the two nuts (Item 1) [B] and turn them to adjust the brake pedal.

With the brake released, lift and release pedal to remove linkage end play.

Adjust the release pedal so there is 2.0 inches  $\pm$  0.100 inches (51 mm  $\pm$  2 mm) from the top of the release pedal to the top of the chaincase cover [C].

Tighten the two nuts when the adjustment is correct.

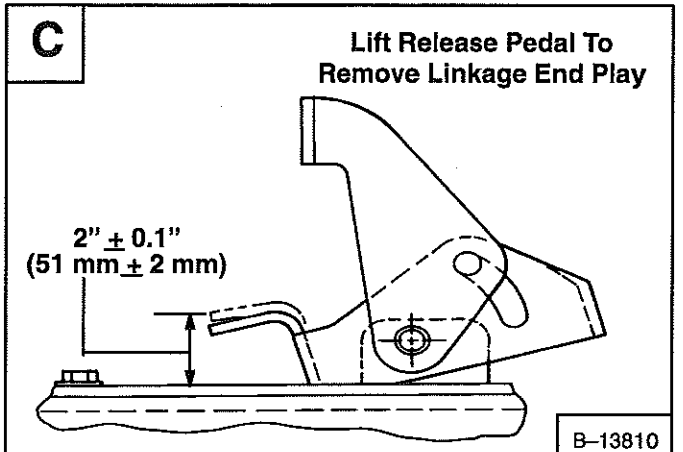
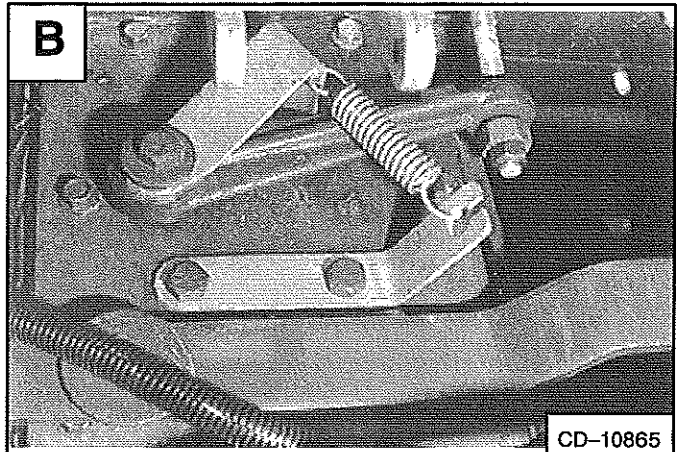
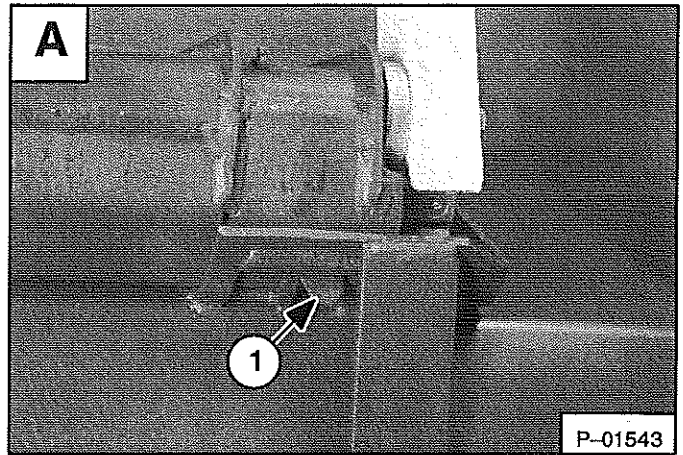









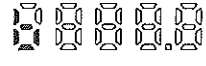
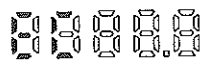

**SYSTEMS ANALYSIS**

SERVICE CODES ..... 59







**SYSTEMS  
ANALYSIS**

# MONITOR SERVICE CODES

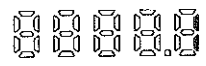
One of the following Alphabetic Codes may appear on your monitor.

- |   |   |
|---|---|
|  Engine Coolant Level          |  battery                  |
|  Engine Coolant Temperature    |  FUEL Level               |
|  Engine Oil Pressure           |  Hydraulic Filter         |
|  Engine Speed                  |  Hydraulic Fluid Pressure |
|  Air Filter                    |   |
|  Hydrostatic Fluid Temperature |   |

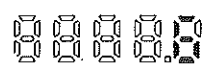
One of the following Numeric Codes will appear following one of the above Alphabetic Codes. Example: 

- |  |
|--|
|  Shut Down            |
|  Warning              |
|  Wiring Not Connected |
|  Wiring Shorted       |
|  High Sensor Voltage  |
|  Sensor No Signal     |
|  Sensor Out of Range  |





## SERVICE CODES

The following list references the defect codes that are transmitted to the instrument panel display which can occur. Some service procedures for correcting the problems can be found in this manual and other procedures must be performed ONLY BY QUALIFIED BOBCAT SERVICE PERSONNEL.

# WARNING

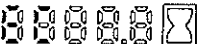
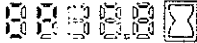
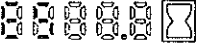

Instructions are necessary before operating or servicing machine. Read Operation & Maintenance Manual, Handbook and signs (decals) on machine. Follow warnings and instructions in the manuals when making repairs, adjustments or servicing. Check for correct function after adjustments, repairs or service. Failure to follow instructions can cause injury or death.

W-2003-0797

SERVICE CODES		
SUBJECT	DISPLAY READS	CONDITION
Engine Coolant Level 	ECL 1	SHUTDOWN, No Coolant
Engine Coolant Temp. 	EC-1.1	SHUTDOWN, Engine Temperature
	EC-2.1	WARNING, Engine Temperature
	EC 3	Wiring Not Connected
	EC 4	Wiring Shorted
	EC 5	High Sensor Voltage
	EC 7	Sensor Out Of Range
Engine Oil Pressure 	EP 1	SHUTDOWN, Pressure
	EP 2	WARNING, Pressure
	EP 3	Wiring Not Connected
	EP 4	Wiring Shorted
	EP 5	High Sensor Voltage
	EP 7	Sensor Out Of Range
Engine Speed 	ES 1	SHUTDOWN, Engine Speed Too High
	ES-2.1	WARNING, Engine Speed Slightly High
	ES-6	Sensor No Signal
	ES-7	Sensor Out Of Range
Air Filter 	AF 2	WARNING, Restriction Too High
	AF 6	Sensor No Signal
Battery 	b-2.1	WARNING, Bad Battery
	b-2.2	WARNING, Battery Voltage
Fuel Level 	FUEL2	WARNING, Low Level
	FUEL3	Wiring Not Connected
	FUEL4	Wiring Shorted
	FUEL5	High Sensor Voltage
	FUEL7	Sensor Out Of Range

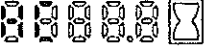

## SERVICE CODES

SUBJECT	DISPLAY READS	CONDITION
Hydrostatic Charge Filter Condition 	HF1-2	WARNING, High Restriction
	HF1-6	Sensor No Signal
Hydrostatic Fluid 	HP 1	SHUTDOWN, Pressure
	HP 2	WARNING, Pressure
	HP 3	Wiring Not Connected
	HP 4	Wiring Shorted
	HP 5	High Sensor Voltage
	HP 7	Sensor Out Of Range
Hydrostatic Fluid Temperature 	HC 1	SHUTDOWN, Temperature
	HC 2	WARNING, Temperature
	HC 3	Wiring Not Connected
	HC 4	Wiring Shorted
	HC 5	High Sensor Voltage
	HC 6	Sensor No Signal
	HC 7	Sensor Out Of Range

## MACHINE SIGN TRANSLATIONS

IMPORTANT (6560573) .....	63
SERVICE SCHEDULE (6708212) .....	65
WARNING (6579510) .....	67
WARNING (6579511) .....	64
WARNING (6577754, 6579528) .....	68
DANGER (6702301, 6702302) .....	68

**MACHINE SIGN  
TRANSLATIONS**

### MACHINE SIGNS (DECALS)

Machine signs (decals) are an essential part of the loader (See Page xiv & xv). This section provides French and Spanish translations of the machine signs that are in English. The Operator's Handbook is also available in a combination English, French, German, Spanish, Italian and Dutch editions.



## IMPORTANTE (SPANISH)

ESTA MAQUINA ESTA EQUIPADA POR LA FABRICA CON UN AMORTIGUADOR DE CHISPAS DEL SILENCIADOR, APROBADO POR EL SERVICIO DE SILVICULTURA DEL U.S.D.A. (DEPARTAMENTO DE AGRICULTURA DE LOS ESTADOS UNIDOS).

ES NECESARIO LIMPIAR ESTE AMORTIGUADOR DE CHISPAS DEL SILENCIADOR PARA MANTENERLO EN BUEN ESTADO. HAY QUE DARLE SERVICIO AL AMORTIGUADOR, VACIANDO LA CAMARA DE CHISPAS CADA 100 HORAS DE FUNCIONAMIENTO.

SI ESTA MAQUINA ESTA DESTINADA PARA TRABAJAR EN BOSQUES, MATORRALES O EN PASTOS QUE PUEDAN INCENDIARSE, ENTONCES TIENE QUE ESTAR EQUIPADA CON UN AMORTIGUADOR DE CHISPAS EN EL SISTEMA DEL ESCAPE Y TIENE QUE MANTENERSE EN PERFECTAS CONDICIONES DE TRABAJO. ES NO HACER ESTO CONSTITUYE UNA INFRACCION DE LA LEY ESTATAL DE CALIFORNIA, SECCION 4442, PRC.

REFIERASE A LAS LEYES Y REGULACIONES LOCALES EN CUANTO A LOS REQUISITOS DEL AMORTIGUADOR DE CHISPAS.

## IMPORTANT (FRENCH)

CETTE CHARGEUSE EST EQUIPEE A LA SORTIE DE L'USINE D'UN SILENCIEUX PARA-ETINCELLES APPROUVE PAR LE SERVICE DES EAUX ET FORETS DES ETATS-UNIS.

IL EST INDISPENSABLE D'EFFECTUER UN ENTRETIEN REGULIER DE CE PARE-ETINCELLES AFIN DE LE GARDER EN BON ETAT DE MARCHÉ. L'ENTRETIEN CONSISTE A VIDER LA CHAMBRE A ETINCELLES TOUTES LES 100 HEURES DE MARCHÉ.

SI CET ENGIN EST UTILISE SUR UN TERRAIN COUVERT D'ARBRES, DE BROUSSAILLES, OU D'HERBAGES INFLAMMABLES, IL FAUT INSTALLER LE PARE-ETINCELLES ET LE GARDER EN BON ETAT DE MARCHÉ.

CONSULTER LES REGLEMENTATIONS LOCALES APPLICABLES.

## IMPORTANT

THIS MACHINE IS FACTORY EQUIPPED WITH A U.S.D.A. FORESTRY SERVICE APPROVED SPARK ARRESTOR MUFFLER.

IT IS NECESSARY TO CLEAN THIS SPARK ARRESTOR MUFFLER TO KEEP IT IN WORKING CONDITION. THE SPARK ARRESTOR MUFFLER MUST BE SERVICED BY DUMPING THE SPARK CHAMBER EVERY 100 HOURS OF OPERATION.

IF THIS MACHINE IS OPERATED ON FLAMMABLE FOREST, BRUSH OR GRASS COVERED LAND, IT MUST BE EQUIPPED WITH A SPARK ARRESTOR ATTACHED TO THE EXHAUST SYSTEM AND MAINTAINED IN WORKING ORDER. FAILURE TO DO SO WILL BE IN VIOLATION OF CALIFORNIA STATE LAW, SECTION 4442, PRC.

REFER TO LOCAL LAWS AND REGULATIONS FOR SPARK ARRESTOR REQUIREMENTS.

SEE THE OPERATION AND MAINTENANCE MANUAL FOR MORE INSTRUCTIONS.

PARA MÁS INSTRUCCIONES, VEA EL MANUAL DE OPERACIÓN Y MANTENIMIENTO.

WEITERE ANWEISUNGEN FINDEN SIE IN DER BETRIEBUNGS- UND INSTANDHALTUNGSANLEITUNG.

VOIR LE MANUEL DE L'OPÉRATEUR ET D'ENTRETIEN POUR D'AUTRES RENSEIGNEMENTS.

6560573

## ADVERTENCIA (SPANISH)

### EVITE HERIDAS O LA MUERTA

- Mantenga la puerta cerrada excepto para dar servicio.
- Mantenga el motor limpio y que no tenga material inflamable.
- Mantenga el cuerpo, objetos sueltos y la ropa lejos de los conductores eléctricos, piezas móviles, piezas calientes y del escape.
- No use el cargador en lugares donde hay polvo o gases explosivos o materiales inflamables cerca al escape.
- Todos los gases del escape pueden matar. Ventile siempre el lugar de trabajo.

- No use nunca éter o líquido del arranque en los motores de diesel que tienen tapones encendedores. Use solamente las ayudas para el arranque que sean aprobados por el fabricante del motor.
- Escapes de líquido bajo presión pueden penetrar en la piel y causar heridas graves. Se requiere atención médica inmediata. Use gafas. Use cartón para revisar si hay fugas.
- El ácido de la batería puede causar quemaduras severas, use gafas. Si el ácido hace contacto con los ojos, la piel o la ropa, lávelos bien con agua. Si el contactor fuel en los ojos, lávelo bien y vaya al médico.
- Las baterías producen gas inflamable y explosivo. Mantenga lejos, arcos, chispas, llamas y tabaco encendido.
- Para arranque con batería auxiliar, conecte de último el cable negativo al motor del cargador (nunca la batería). Después de hacer el arranque con cables, quite primero la conexión negativa del motor.



## WARNING

### AVOID INJURY OR DEATH

- Keep door closed except for service.
- Keep engine clean of flammable material.
- Keep body, loose objects and clothing away from electrical contacts, moving parts, hot parts and exhaust.
- Do not use loader in space with explosive dusts or gases or with flammable material near exhaust.
- All exhaust gases can kill. Always ventilate.
- Never use ether or starting fluid on diesel engine with glow plugs. Use only starting aids as approved by engine manufacturer.
- Leaking fluids under pressure can enter skin and cause serious injury. Immediate medical attention is required. Wear goggles. Use cardboard to check for leaks.
- Battery acid causes severe burns wear goggles. If acid contacts eyes, skin or clothing, flush well with water. For contact with eyes flush and get medical attention.
- Battery makes flammable and explosive gas. Keep arcs, sparks, flames and lighted tobacco away.
- For jump start, connect negative cable to the loader engine last (never at the battery). After jump start, remove negative connection at the engine first.

6579511

- Les liquides sous pression peuvent pénétrer au travers de la peau et causer de graves blessures. Consulter immédiatement un médecin Porter des lunettes de sécurité. Utiliser du carton pour repérer les fuites.
- L'acide des batteries provoque de graves brûlures, porter des lunettes de sécurité. S'il entre en contact avec les yeux, la peau ou les vêtements, rincer généreusement à l'eau. Pour les yeux, appeler un médecin.
- Les batteries dégagent des gaz inflammables et explosifs. Tenir les arcs électriques les étincelles, les flammes et les cigarettes allumées à l'écart.
- En cas de démarrage par pontage, effectuer le dernier branchement (Câble négatif) au moteur (jamais à la batterie). Pour débrancher, déconnecter d'abord le câble négatif du moteur.
- Ne jamais utiliser d'éther ou de liquide de démarrage sur un moteur diesel avec des bougies de préchauffage. N'employer que les aides au démarrage approuvées par le fabricant.

## AVERTISSEMENT (FRENCH)

### EVITER LES BLESSURES, VOIRE LA MORT

- Maintenir la porte arrière fermée, sauf pour les entretiens.
- Débarasser le moteur de toute matière inflammable.
- Maintenir le corps, les objets non attachés et les vêtements à l'écart des contacts électriques, des pièces mobiles et brûlantes et de l'échappement.
- Ne pas utiliser la machine dans un endroit chargé de poussières ou de gaz explosifs, et où l'échappement risque de toucher des matériaux inflammables.
- Les gaz d'échappement peuvent être mortels. Toujours aérer.

## SERVICE SCHEDULE

### EVERY 10 HOURS (BEFORE STARTING THE LOADER)

1. Engine Oil — Check level — do not overfill. (See Operation & Maintenance Manual for recommended oil).
2. Engine Air Filter — Check gauge and/or display. Service only when required.
3. Engine Cooling System — Clean debris from oil cooler, radiator and grill. Check coolant level each shift. Add 50% propylene glycol premixed with 47% water as needed.
4. Loader Lift Arm, cylinders, Bob-Tach pivot and wedges, lubricate with multi-purpose lithium base grease.
5. Engine Air System — Check for leaks and damaged components.
6. General — Check for loose or broken parts, damaged operator cab, instrument operations, loose wheel nuts, oil leaks. Repair or replace as needed.
7. Seat Belt/Seat Bar and Control Interlocks — Check function. Repair or replace as needed. Clean dirt and debris from moving parts.
8. Fuel Filter — Remove trapped water (diesel engine only).
9. BICS — Check for function. Clean dirt, debris or objects from under and back of seat as required.
10. Tires — Check inflation pressure. Inflate tires to the MAXIMUM pressure shown on the sidewall of the tire.

### EVERY 50 HOURS

1. Hydraulic Fluid — Check the fluid level. See your Operation & Maintenance Manual for recommended fluid.
2. Chaincase — Check the fluid level. See your Operation & Maintenance Manual for recommended fluid.
3. Battery — Check condition.
4. Controls — Check operation, adjust if needed.
5. Engine Oil (450 Loader Only) — Drain when engine is at operating temperature. See Operation & Maintenance Manual.

### EVERY 100 HOURS

1. Spark Arrestor Muffler — Empty spark chamber.
2. Ignition System — If using leaded fuel, check spark plugs and ignition system. If using unleaded fuel, service only as required to maintain good starting and smooth operation (Gas Engine Only).
3. Engine Oil — Drain when engine is at operating temperature and replace filter. See Operation & Maintenance Manual. (Every 250 hours for 700 models with a KUBOTA engine.)
4. Check all belt drives — Water pump and alternator and fan drive for condition and tension. Adjust or replace as needed.
5. Hydraulic/Hydrostatic System (400's and 500's only) — Replace the filter element. NOTE: The filter element must be replaced sooner if transmission warning indicator remains on for more than 5 minutes after hydraulic fluid is at operating temperature.

### EVERY 250 HOURS (OR EVERY 12 MONTHS)

1. Final Fuel Filter — Replace filter element.
2. Steering Lever Pivots — Lubricate with multi-purpose lithium based grease (2 places).
3. Transmission Drive Belt — Check and adjust if needed. Check replacement drive belt after the first 50 hours of operation and adjust if needed.
4. Drive Line (500's only) — Lubricate U-joint. See Operation & Maintenance Manual for recommended grease.
5. Hydraulic/Hydrostatic System — Replace reservoir breather cap and replace the filter element (SES-Replace two (2) filter elements). NOTE: The filter element must be replaced sooner if transmission warning indicator remains on for more than 5 minutes after hydraulic fluid is at operating temperature.

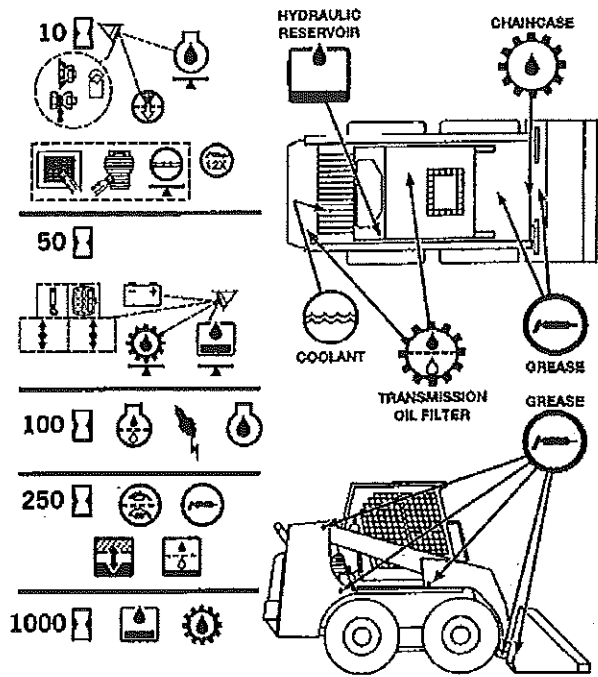

### EVERY 1000 HOURS (OR EVERY 12 MONTHS)

1. Hydraulic Reservoir — Replace fluid. See Operation & Maintenance Manual for recommended fluid.
2. Drive Motor Case Drain Filters — Clean or Replace if equipped.
3. Chaincase — Drain fluid and replace. See your Operation & Maintenance Manual for recommended fluid.
4. Fan Drive Gearbox — Check fluid level. See your Operation & Maintenance Manual for recommended fluid.
5. BICS — Check lift arm bypass control. See the Operation & Maintenance Manual for more instructions. Weitere Anweisungen finden sie in der Bedienungs- und Instandhaltungsanleitung. Para más instrucciones, vea el Manual de Operación y Mantenimiento. Voir le Manuel de l'opérateur et d'entretien pour d'autres renseignements.

## PROGRAMA DE SERVICIO (SPANISH)

### CADA 10 HORAS

1. Aceite del Motor—Revise el nivel—no lo llene demasiado (Consulte el Manual del Operario para saber que aceite recominenda).
2. Filtro del Aire del Motor—Revise el medidor y/o el cuadrante. Dele servicio solamente cuando se necesite.
3. Sistema de refrigeración del motor—Eliminar suciedad del refrigerador, del radiador y de las rejillas. Medir el nivel con el refrigerante frio. Completar con mezcla etilenglicol y agua (53/47).
4. Brazo de Elevación del Cargador, Cilindros, Pivote y Cuñas del Bob—Tach—Lubriquearlos con grase de base de litio para uso múltiple (12 sitios).
5. Sistema de Aire del Motor—Revise para ver si hay fugas o componentes dañados.
6. En General—Verifique a ver si hay piezas flojas o rotas, daños en el cinturón de seguridad o en la cabina del operario, revise también el funcionamiento de los instrumentos, vea si hay tuercas flojas en las ruedas y fugas de aceite. Inspeccione el funcionamiento de la barra del aciento y arregle o reemplace la que sea necesario antes e poner a trabajar el cargador.
7. Cinturón de seguridad/Dispositivos de bloque de la barra de asiento y controles—Compruebe función. Repare o reemplace como sea necesario. Limpie suciedad y escombros en las partes móviles.
8. Filtro del Combustible—Purgue el agua atrapada (Únicamente motor de diesel).
9. BICS—Verifique la función. Limpie la suciedad, escombros u objetos de abajo o de atrás del asiento tal como se requiere.

10. Liantas—Controle la presión de inflación. Infle las liantas hasta la presión. MAXIMA que se indica en la pared del costado de la llanta.

### CADA 50 HORAS

1. Líquido Hidráulico—Revise el nivel del líquido. Vea el Manual del Operario para saber el líquido recomendado.
2. Caja de la Cadena—Revise el nivel del líquido. Vea su Manual del Operario para saber el líquido recomendado.
3. Bateria—Revise su condición.
4. Mandos y Frenso—Verifique su funcionamiento, ajustelos si es necesario.
5. Aceite del motor (solo en las cargadoras 450)—Vaciar cuando el motor está a su temperatura de trabajo. Ver Manual de Utilización y de Mantenimiento.

### CADA 100 HORAS

1. Silenciador con Amortiguador de Chispas—Desocupe la cámara de las chispas.
2. Sistema del Encendido—Si usa combustible que contine plomo, inspeccione las bujías y el sistema del encendido. Si usa combustible sin plomo, de servicio únicamente cuando sea necesario para mantener un encendido bueno y funcionamiento suave (Únicamente para Motores de Gasolina).
3. Vacie el aceite del motor cuando este está a su temperatura de trabajo. Ver Manual de Utilización y de Mantenimiento. (Cada 250 horas para 700 modelos con la KUBOTA motor.)
4. Inspeccione todas las correas de impulso—Verifique las condición y la tensión de todas las correas—Impulso del hidrostático, impulso de la bomba del agua, el alternador y el ventilador. Ajustelas y reemplácelas a media que sea necesario.



5. Sistema hidráulico/hidrostatico (solamente modelos 400 y 500)—Cambiar el filtro. Nota: El filtro ha de cambiarse antes si el indicador de aviso de la transmisión permanece encendido más de 5 minutos después de que el fluido hidráulico haya alcanzado su temperatura de trabajo.

#### **CADA 250 HORAS (O CADA 12 MESES)**

1. Filtro Final del Combustible—Reemplace el elemento del filtro.
2. Pivotes de la Palanca de la Dirección—Lubríquelos con grasa de base de litio para uso múltiple (2 sitios).
3. \*Correa de transmisión. Comprobar si está desgastada o deteriorada. Ajustar si es necesario.  
\*Inspeccione la nueva correa después de transcurridas las primeras 50 horas de funcionamiento. Ajustar si es necesario.
4. Transmisión (500 solamente)—Engrasar acoplamiento universal de la transmisión (modelo 500's solamente). Ver tipo de grasa en el Manual de Utilización y de Mantenimiento.
5. Sistema hidráulico/hidrostatico—Reemplazar el tapón respiradero del depósito hidráulico y cambiar el elemento del filtro. (853—reemplazar 2 elementos de filtro). Nota: El elemento filtrante debe ser cambiado antes si el indicador de la transmisión permanece encendido más de 5 minutos después de que el fluido hidráulico haya alcanzado su temperatura de trabajo.

#### **CADA 1000 HORAS (O CADA 12 MESES)**

1. Depósito hidráulico—Reemplazar el aceite. Véase tipo de aceite en el Manual de Utilización y de Mantenimiento.
2. Filtro de purge de los motores hidráulicos—Limpiar o cambiar si existen.
3. Carter de la cadena—Vaciar y reemplazar el aceite. Véase tipo de aceite en el Manual de Utilización y de Mantenimiento.
4. Carter de engranajes del ventilador—Comprobar el nivel. Véase tipo de aceite en el Manual de Utilización y de Mantenimiento.
5. BICS—Comprobar el mando auxiliary de derivación de los brazos de elevación.

### **PROGRAMME D'ENTRETIEN (FRENCH)**

#### **TOUTES LES 10 HEURES**

1. Huile moteur—Contrôler le niveau—Ne pas dépasser le niveau (consulter le Manuel de l'Opérateur et d'Entretien pour l'huile recommandée).
2. Filtre à air du moteur—Contrôler la jauge et/ou l'affichage. Entretien uniquement si nécessaire.
3. Circuit de refroidissement du moteur—Nettoyer les débris du refroidisseur d'huile, du radiateur et des grilles. Contrôler à froid le niveau de liquide de refroidissement et rajouter si nécessaire un mélange d'éthylène-glycol/eau à 53/47.
4. Bras de levage de la chargeuse, vérins, pivots et du Bob—Tach: lubrifier avec de la graisse tous usages à base de lithium (12 points).
5. Circuit d'air du moteur—Rechercher les fuites et les éléments endommagés.
6. Généralités—Rechercher les pièces desserrés ou brisées, voir si la ceinture de sécurité est endommagée de même que la cabine de l'opérateur, contrôler le fonctionnement des instruments, rechercher les écrous de roue desserrés, les fuites d'huile, etc... Vérifier l'arceau de sécurité et réparer ou remplacer selon besoin avant d'utiliser la chargeuse.
7. Ceinture de sécurité/Verrouillages de barre de siège et de commandes—Fonction de vérification. Réparer ou remplacer selon les besoins. Nettoyer la saleté et les débris.
8. Filtre d'alimentation—Vidanger l'eau de condensation (moteur diesel uniquement).

9. BICS—Vérifiez le fonctionnement. Nettoyez la saleté, les débris ou les objets se trouvant sous ou derrière le siège selon le besoin.
10. Pneus—Vérifiez la pression de gonflage. Gonflez les pneus à la pression MAXIMUM indiquée sur la paroi latérale des pneus.

#### **TOUTES LES 50 HEURES**

1. Huile hydraulique—Vérifier le niveau d'huile. Consulter le Manuel de l'Opérateur et d'Entretien pour l'huile.
2. Carter de chaînes—Vérifier le niveau. Consulter le Manuel de l'Opérateur et d'Entretien pour l'huile.
3. Batterie—Contrôler l'état de la batterie.
4. Commandes et freins—Contrôler le fonctionnement et régler si nécessaire.
5. Huile moteur (série 450 uniquement)—Vidanger à chaud. Consulter le Manuel de l'Opérateur et d'Entretien.

#### **TOUTES LES 100 HEURES**

1. Silencieux para-étincelles—Vider la chambre à étincelles.
2. Circuit d'allumage—Si on utilise de carburant au plomb, vérifier les bougies et l'allumage. Si on utilise du carburant sans plomb, effectuer l'entretien uniquement selon besoin afin de maintenir de bonnes performances au démarrage et un fonctionnement régulier (moteur à essence uniquement).
3. Huile moteur—Vidanger à chaud et changer le filtre. Consulter le Manuel de l'Opérateur et d'Entretien. (Toutes les 250 heures pour les séries 700 équipées d'un moteur KUBOTA.)
4. Contrôler tous les entraînements par courroie: hydrostatique, pompes à eau, alternateur et ventilateur; vérifier l'état et la tension des courroies. Régler ou remplacer selon besoin.
5. Circuit hydraulique/hydrostatique (séries 400 et 500 uniquement)—Replacer l'élément du filtre.

Remarque: L'élément de filtre doit être remplacé plus tôt si le signal d'avertissement pour la transmission reste allumé plus de 5 minutes après que l'huile ne soit à température.

#### **TOUTES LES 250 HEURES (OU TOUS LES 12 MOIS)**





1. Filtre d'alimentation final—Remplacer l'élément du filtre.
2. Pivots des leviers de direction—Lubrifier avec de la graisse tous usages à base de lithium (2 points).
3. Courroie de transmission—Vérifier et tendre si nécessaire. Vérifier la courroie de remplacement après 50 heures d'utilisation et régler si nécessaire.
4. Transmission (série 500 uniquement)—Graisser le cardan. Consulter le Manuel de l'Opérateur et d'Entretien.
5. Circuit hydraulique/hydrostatique—Remplacer le bouchon de reniflard du réservoir hydraulique et remplacer l'élément de filtre (853—remplacer deux (2) éléments de filtre). Remarque: L'élément de filtre doit être remplacé plus tôt si le signal d'avertissement de transmission reste allumé plus de 5 minutes après que le liquide hydraulique soit à température.

#### **TOUTES LES 1000 HEURES (OU TOUS LES 12 MOIS)**

1. Réservoir hydraulique—Remplacer l'huile. Consulter le Manuel d'Opération et d'Entretien pour l'huile recommandée.
2. Filtre de drain de moteurs de transmission—Nettoyer ou remplacer si existant.
3. Carter de chaînes—Vidanger l'huile et la remplacer. Consulter le Manuel de l'Opérateur et d'Entretien pour l'huile recommandée.
4. Réducteur du ventilateur—Contrôler le niveau d'huile. Consulter le Manuel de l'Opérateur et d'entretien pour l'huile recommandée.
5. BICS—Vérifier le fonctionnement de la vanne de descente du bras de levage.

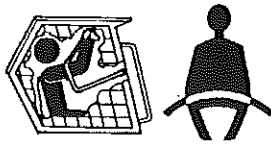
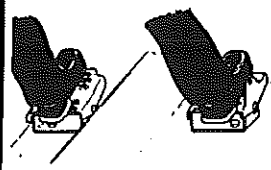
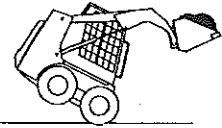
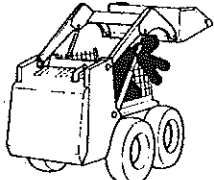
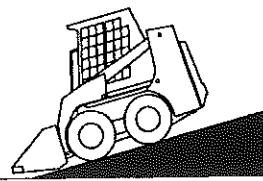
# ⚠ WARNING

## AVOID INJURY OR DEATH

 <p>NEVER USE THE LOADER WITHOUT INSTRUCTIONS. READ OPERATION AND MAINTENANCE MANUAL AND HANDBOOK.</p>	 <p>USE SEAT BAR. FASTEN SEAT BELT SECURELY.</p>	 <p>KEEP FEET ON PEDALS.</p>	<b>TO LEAVE THE LOADER:</b>	
 <p>DO NOT TRAVEL OR TURN WITH LIFT ARMS UP. LOAD, UNLOAD AND TURN ON FLAT LEVEL GROUND. DO NOT EXCEED RATED OPERATING CAPACITY (SEE SIGN ON LOADER).</p>	 <p>NEVER MODIFY EQUIPMENT OR USE ATTACHMENTS NOT APPROVED BY MELROE COMPANY.</p>	 <p>ON SLOPES, KEEP HEAVY END OF LOADER UPHILL.</p>	1  <p>LOWER THE LIFT ARMS PUT ATTACHMENT FLAT ON GROUND.</p>	2  <p>STOP THE ENGINE</p>
			3  <p>ENGAGE THE BRAKE.</p>	4  <p>RAISE SEAT BAR. MOVE PEDALS UNTIL BOTH LOCK.</p>
<p>Weltere Anweisungen finden sie in der Bedienungs- und Instandhaltungsanleitung. Para más instrucciones, vea el Manual de Operación y Mantenimiento. Voir le Manuel de l'opérateur et d'entretien pour d'autres renseignements.</p> <p>6579510</p>				

### ADVERTENCIA (SPANISH)

#### EVITE HERIDAS O LA MUERTE

NO USE NUNCA EL CARGADOR SIN LEER LAS INSTRUCCIONES.  
LEA EL MANUAL DEL OPERATIO, EL MANUAL DE SERVICIO Y LA GIA DEL OPERARIO.

NO VIAJE O DE LA VUELTA CON LOS BRAZOS DE ELEVACION ARRIBA.  
CARGUE, DESCARGUE Y DE LA VUELTA ESTANDO EN UN SITIO PLANO Y NIVELADO.  
NO EXCEDA LA CAPACIDAD NOMINAL DE FUNCIONAMIENTO (VEA EL AVISO EN EL CARGADOR).

USE LA BARRA DEL ASIENTO.  
ASEGURESE BIEN EL CINTURON DE SEGURIDAD.

NUNCA MODIFIQUE EL EQUIPO NI USE ADITAMENTOS QUE NO ESTEN APROBADOS POR LA COMPAÑIA MELROE.

MANTENGA LOS PIES EN LOS PEDALES.

EN LA PENDIENTES, MANTENGA EL EXTREMO PESADO DE CARGADOR EN POSICION ASCENDENTE.

#### ANTES DE BAJARSE DEL CARGADOR

1. BAJE LOS BRAZOS DE ELEVACION.  
COLOQUE EL ADITAMENTO BEIN EN EL SUELO.
2. PARE EL MOTOR.
3. PONGA EL FRENO.
4. LEVANTE LA BARRA DEL ASIENTO.  
MUEVA LOS PEDALES HASTA QUE AMBOS SE TRABEN.

### ATTENTION (FRENCH)

#### EVITER LES BLESSURES OU LA MORT

NE JAMAIS SE SERVIR DE LA CHARGEUSE SANS INSTRUCTIONS.  
LIRE LE MANUEL DE L'OPERATEUR EL D'ENTRETIEN AINSI QUE LE GUIDE D'UTILISATION.

NE PAS SE DEPLACER NI VIRER AVEC LE BRAS RELEVES.  
CHARGER, DECHARGER ET VIRER SUR UN SOL PLAT ET HORIZONTAL.  
NE PAS DEPASSER LE CAPACITE NOMINALE (CONSULTER L'AUTOCOLLANT APOSE SUR LA CHARGEUSE).

UTILISER L'ARCEAU DE SECURITE.  
ATTACHER SOIGNEUSEMENT LA CEINTURE DE SECURITE.

NE JAMAIS MODIFIER L'EQUIPEMENT NI SE SERVIR D'ACCESSOIRES QUE NE SONT PAS APPROUVES PAR MELROE COMPANY.

MAINTENIR LES PIEDS SUR LES PEDALES.

DANS LES PENTES, TOUJOURS MAINTENIR LA PARTIE LA PLUS LOURDE DE LA CHARGEUSE VERS LE HAUT.

#### POUR QUITTER LA CHARGEUSE:

1. ABAISSER LES BRAS DE LEVAGE.  
POSER L'EQUIPEMENT A PLATE SUR LE SOL.
2. ARRETER LE MOTEUR.
3. ENCLENCHER LE FREIN DE STATIONNEMENT.
4. RELEVER L'ARCEAU DE SECURITE.  
DEPLACER LES PEDALES JUSQU'A CE QU'ELLES SOIENT TOUTES DEUX VERROILLEES.



**ADVERTENCIA (SPANISH)**

**EVITE HERIDAS O LA MUERTE**

**LLEVE LA CARGA EN POSICION BAJA**

EL NO OBEDECER ESTA ADVERTENCIA PUEDE CAUSAR LADEAMIENTO O VUELCOS O PERDIDA DE LA CARGA Y DE LA VISIBILIDAD.

**AVERTISSEMENT (FRENCH)**

**EVITER DES BLESSURES OU LA MORT**

**TENIR LA CHARGE VERS LE BAS.**

LE NON RESPECT PEUT ENTRAINER UN BASCULEMENT OU UN RENVERSEMENT DE LA MACHINE, UNE PERTE DE LA CHARGE OU DE VISIBILITE.

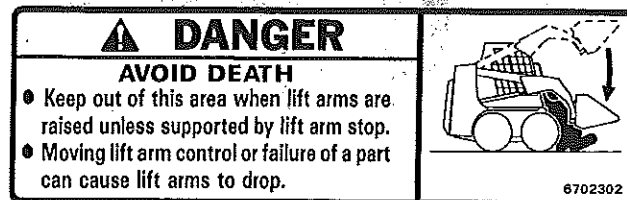

**PELIGRO (SPANISH)**

**EVITE LA MUERTE**

- MANTENGASE RETIRADO DE ESTA AREA CUANDO LOS BRAZOS DE ELEVACION ESTAN ELEVADOS, A MENOS QUE ESTEN TRABADADOS POR EL TOPE.
- EL MOVER EL PIE DEL PEDAL O FALLA DE UNA PIEZA PUEDEN CAUSAR LA CAIDA DE LOS BRAZOS DE ELEVACION.

**DANGER (FRENCH)**

**EVITER LA MORT**

- EVITER CETTER ZONE LORSQUE LES BRAS DE LEVAGE RELEVÉS NE SONT PAS ASSURÉS PAR DES ARRETS DE BRAS DE LEVAGE.
- UNE PEDALE ACTIONNÉE OU UNE PICE DEFECTUEUSE. PEUT PROVOQUER L'ABAISSEMENT DES BRAS DE LEVAGE.



**ADVERTENCIA (SPANISH)**

EL CILINDRO CONTIENE GAS BAJO ALTA PRESION. EL ABRIR EL CILINDRO PUEDE SOLTAR LA VARILLA Y CAUSAR HERIDAS O LA MUERTE.

**AVERTISSEMENT (FRENCH)**

LES VERINS RENFERMENT UN GAZ SOUS PRESSION. NE JAMAIS OUVRIR UN VERIN CAR LA TIGE RISQUE DE S'ÉCHAPPER BRUTALEMENT ET DE CAUSER DES BLESSURES OU MEME LA MORT.

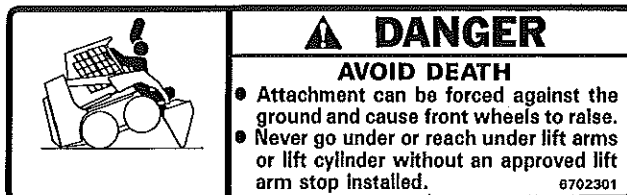

**PELIGRO (SPANISH)**

**EVITE LA MUERTE**

- EL FORZAR EL IMPLEMENTO CONTRA EL SUELO HACE QUE LA RUEDDAS DELANTERAS SE ELEVEN.
- NUNCA SE META DEBAJO NI ALCANCE NADA DEBAJO DE LOS BRAZOS DE ELEVACION O DEL CILINDRO DE ELEVACION SIN QUE ESTE INSTALADO UN TOPE APROBADO EN LOS BRAZOS DE ELEVACION.

**DANGER (FRENCH)**

**EVITER LA MORT**

- L'ACCESSOIRE PEUT ETRE APPUYE CONTRE LE SOL ET SOULEVER LES ROUES AVANT.
- NE JAMAIS ALLER SOUS NI METTRE LES MAINS SOUS LES BRAS OU LE VERIN DE LEVAGE SANS QU'UN ARRET DE BRAS DE LEVAGE APPROUVE SOIT INSTALLE.

## SPECIFICATIONS

CAPACITIES .....	74
DRIVE SYSTEM .....	74
ELECTRICAL .....	74
ENGINE SPECIFICATIONS .....	73
HYDRAULIC SYSTEM .....	74
OPERATION & PERFORMANCE .....	73
TIRES .....	74

**SPECIFICATIONS**



# LOADER SPECIFICATIONS

## LOADER DIMENSIONS

- Dimensions are given for loader equipped with standard tires and dirt bucket. Dimensions may vary with other types. All dimensions are shown in inches. Respective metric dimensions are given in millimeters enclosed by parentheses.
- Where applicable, specifications conform to SAE standards and are subject to change without notice.

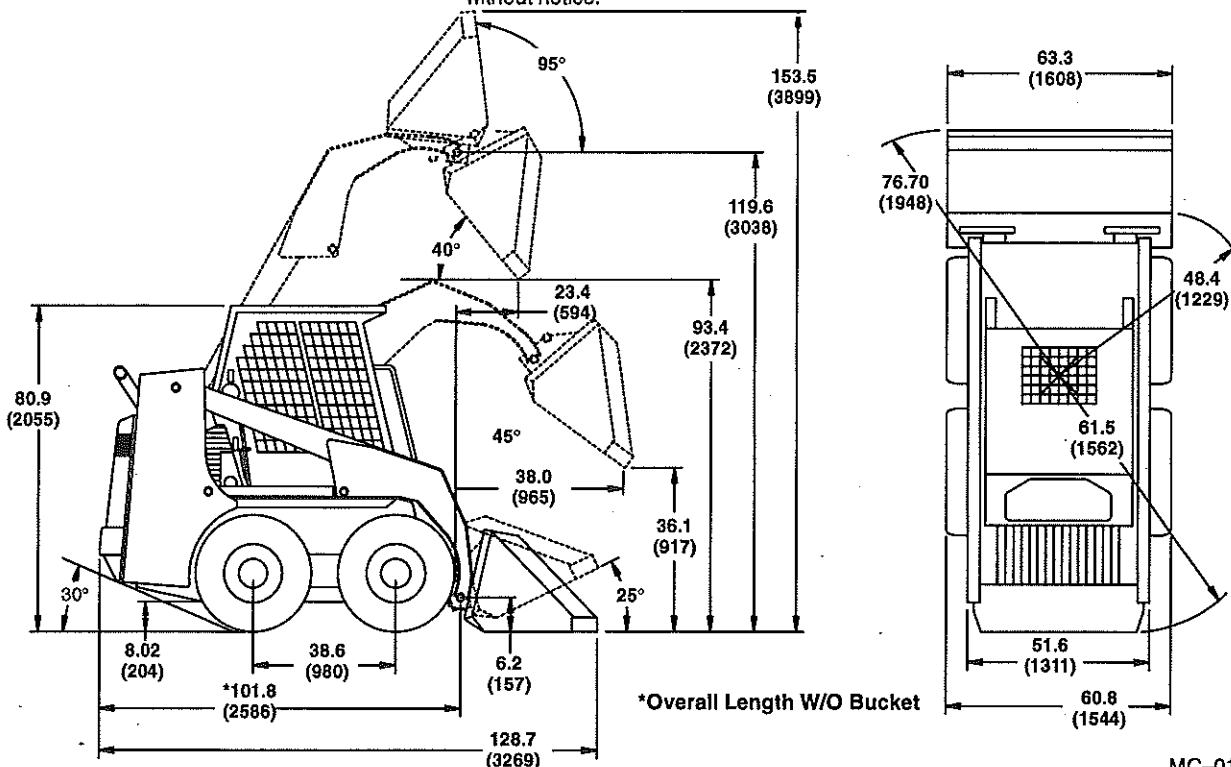

MC-01113

This loader was designed without counterweights or ballasts. Changes of structure or weight distribution of the loader can cause changes in control and steering response and can cause failure of the loader parts.

## OPERATION & PERFORMANCE

### Weights

Operating Weight .....  
 Rated Operating Capacity .....  
 Tipping Load .....

6497 lbs. (2950 kg)  
 1700 lbs. (722 kg)  
 3420 lbs. (1553 kg)

### Travel Speed

Infinitely variable 0-6.4 MPH (10,3 km/hr.)

### Controls

Vehicle .....  
 Loader Function .....

Direction & speed controlled by two hand levers.  
 Lift, tilt function controlled by separate foot pedals. Auxiliary functions controlled by electrical push buttons on steering levers  
 Hand lever speed control; key-type starter switch;  
 Hydrostatic  
 Mechanical disc, foot operated pedal

Engine .....  
 Main Drive .....  
 Parking Brake .....

## ENGINE

Make .....  
 Model .....  
 Fuel .....  
 Horsepower .....  
 Maximum Governed RPM .....  
 Torque .....  
 Number of Cylinders .....  
 Bore/Stroke .....  
 Displacement .....  
 Cooling System .....  
 Lubrication .....  
 Crankcase Ventilation .....  
 Air Cleaner .....  
 Ignition .....  
 Low Idle .....  
 High Idle .....

Isuzu  
 4JB1 PK-03  
 Diesel  
 62 HP (46 kw)  
 2600 RPM  
 137 ft.-lbs. (186 Nm) @ 1800 RPM  
 Four  
 3.66/4.02 (93/102)  
 169.0 cu.in. (2769 cu. cm.)  
 Liquid  
 Pressure System W/Filter  
 External  
 Dry replaceable cartridge, dual safety element  
 Diesel-Compression  
 1150 RPM  
 2750-2850 RPM



## LOADER SPECIFICATIONS (Cont'd)

### HYDRAULIC SYSTEM

<b>853</b>	
Pump .....	Engine driven gear type
Pump Capacity .....	18.0 GPM (68,1 L/min.) @ 2750 RPM @ 1150 PSI (7929 kPa)
Hi Flow Pump Capacity (Optional) .....	24 GPM (90,8 L/min.) @ 2750 RPM @ 1150 PSI (7929 kPa)
System Main Relief .....	2550-2600 PSI (17582-17927 kPa) @ Quick Couplers
Filter .....	Full flow replaceable #3 micron synthetic medial element
Hydraulic Cylinders .....	Doubleacting
Bore Diameter:	
Lift Cylinder (2) .....	2.25 (57,2)
Tilt Cylinder (1) .....	3.25 (82,6)
Rod Diameter:	
Lift Cylinder (2) .....	1.5 (38,1)
Tilt Cylinder (1) .....	1.50 (38,1)
Stroke:	
Lift Cylinder (2) .....	35.3 (851)
Tilt Cylinder (1) .....	18.9 (480)
Control Valve .....	3-spool, open center, series type W/float detent on lift, single spool electrical control front. Auxiliary & electrical controlled rear auxiliary
Fluid Lines .....	SAE standard tubes, hoses & fittings
Hydraulic Function Time:	
Raise Lift Arms to Maximum Height .....	4.0 Seconds
Lower Lift Arms from Maximum Height ..	3.6 Seconds
Move Empty Bucket to Dump Position ..	2.3 Seconds
Move Bucket to Retracted Position .....	1.9 Seconds
Fluid Type .....	Bobcat Fluid (P/N 6563328) If fluid is not available, use 10W-30/10W-40 Class SE Motor Oil for temperatures above 0°F. (-18°C) & 5W-30 Motor Oil for temperatures below 0°F (-18°C).
<b>ELECTRICAL</b>	
Alternator .....	Belt drive, 55 amps. Open
Battery .....	12 volt, 700 cold crank amps. @ 0°F (-18°C) 170 min. reserve capacity
Starter .....	12 volt, 3.7 HP (2,8 kW)
<b>DRIVE SYSTEM</b>	
Transmission .....	Tandem hydro. pumps infinitely variable, driving 2 fully reversing hydrostatic motors
Final Drive .....	Gear reduction & #100 HS roller chain & sprockets in sealed chaincase with oil lubrication
Total Engine to Wheel Reduction .....	47:27:1
Filters .....	Case drain 90 micron
<b>CAPACITIES</b>	
Cooling System .....	22 qts. (20,8 L)
Fuel .....	25 gals. (95 L)
Engine Oil W/Filter .....	8 qts. (7,6 L)
Hydraulic Reservoir .....	15.5qts. (14,7 L)
Hydraulic/Hydrostatic System .....	8 gals. (30,3 L)
Chaincase Reservoir .....	9 gals. (34,1 L)
<b>TIRES</b>	
Standard .....	8.25-15, 6 Ply Rating, Nylon W/Bar Lug Tread
Pressure .....	45-50 PSI (310-345 kPa)
Flotation .....	12:00-16.5, 6 Ply Rating, Nylon W/Sure Grip Lug
Pressure .....	30-35 PSI (207-240 kPa)
Flotation .....	12:00-16.5, 8 Or 10 Ply Rating
Pressure .....	45-50 PSI (310-345 kPa)

**MELROE COMPANY APPROVED ATTACHMENTS & ACCESSORIES – For use on 853 Bobcat Loaders**

These and other attachments are approved for use on this model Bobcat loader. Do not use unapproved attachments. Attachments not manufactured by Melroe Company may not be approved.

The versatile Bobcat loader quickly turns into a multi-job machine with a tight-fit attachment hook-up . . . from bucket to grapple to pallet fork to backhoe and a variety of other attachments. See your Bobcat loader dealer for more details on the attachments and field accessories shown on the following pages.

Increase the versatility of your Bobcat loader with a variety of bucket styles and sizes. Styles and sizes include:

BUCKETS	DESCRIPTION
6576902	66" Construction & Industrial Bucket
6576903	66" Construction & Industrial with Teeth
6703274	66" Low Profile Bucket
6703927	66" Low Profile with Teeth
6576893	60" Dirt Bucket
6704549	60" Utility Bucket
6704486	66" Utility Bucket
6705057	72" Utility Bucket
6558681	60" Fertilizer Bucket
6569905	66" Fertilizer Bucket
6576900	66" Light Material Bucket
6565774	78" Scraping Bucket

Combination Bucket	
- 60 inch	6594519
W/Teeth	6594517
- 66 inch	6594312
W/Teeth	6594134



Perform a wide variety of job functions. The versatile Melroe Bobcat Combination Bucket is ideal for dozing, grapping, leveling, digging, loading and dumping comes with or without teeth.

**Rear Stabilizer** 6701019  
(Recommended for use with backhoe)

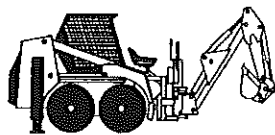

Increase your backhoe performance. Increase your versatility in a wide range of jobs with a set of frame mounted Bobcat Loader rear stabilizers.

**709 Backhoe** 6532700  
**811 Backhoe** 6536300

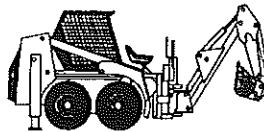

Bobcat backhoe attachments are designed for the pipeliner, municipal worker or contractor, for high production digging.

**Angle Broom** 6536901



Put your Bobcat loader to work and clean up almost everything in sight with the hydraulically driven Angle Broom attachment. Use it to sweep driveways, sidewalks, parking lots, loading docks, warehouses, or countless other applications.

**Grader Scarifier Kit** 6578027  
6578506



Turn your Bobcat loader into a high performance grading machine. Designed for use by landscaping, asphalt, curb and gutter and concrete flatwork contractors. Featuring a seven foot, six-way hydraulically controlled moldboard, operated with switches mounting on the loader's steering levers for precise control.

**Econo-Grader** 6703787



Two attachment options in one! Use it as an economical, but effective grader OR a box blade by utilizing locking end plates. Angle of the seven-foot moldboard is manually adjusted. Blade pitch adjusted by hydraulically tilting the Bob-Tach.

**Sweeper**  
- 60 inch 6594347  
- 72 inch 6594354

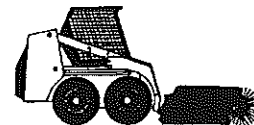

Cleans up construction sites. Cutting edge for scraping mud. Sweeps parking lots, warehouse, docks, etc. Sweeps and collects debris with one attachment.

**Landscape Rake**  
Model 5 A 6594600  
Model 6 A 6594700



Break up lumpy soil, pick up rocks as small as 3/4", grade, level and scarify in close quarters with the Bobcat Landscape Rake. Use it for ground preparation, for seeding, sodding and lawn leveling. Pick up rocks or hard-packed clumps of soil and dump them where you need them with the Bobcat Landscape Rake.

**Vibratory Roller**  
W/Smooth Drum 6578029  
or W/Padded Drum 6578034

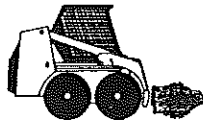

Pack and level smooth and easy. The Bobcat Loader Vibratory Roller features either a smooth or padded 48-inch wide drum. The roller provides up to 4156 pounds of force at 2153 vibrations per minute and is ideal for flatwork, trenching and asphalt patchwork contractors. A bolt-on smooth outer shell is also available for converting the padded drum to a smooth drum.

**Planer (853H Only)**  
Hydraulic Adjust 6704002  
Manual Adjust 6704001



The Bobcat becomes an effective, cost-efficient planing machine with the Melroe Planer attachment. Quickly removes deteriorated asphalt surfaces. An ideal tool for busy municipal and construction contractors.

Some attachments may not be available from your local dealer.

## MELROE COMPANY APPROVED ATTACHMENTS & ACCESSORIES (Cont'd)

### Scarifier

6563526

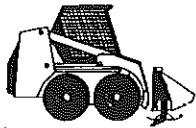

Adjustable depth skids for presetting digging depth. Prepares hard-packed ground for digging or landscaping. One-to-seven-tooth versatility. Standard five-tooth unit with additional teeth available. Rips asphalt for removal.

### Industrial Bucket Grapple

- 60 inch 6706599  
- 66 inch 6704770



Clamp onto heavy and odd-shaped objects, and move them with ease. The Bobcat Industrial Grapple is the ideal attachment for handling scrap, waste or pipe. It's built strong for tough working conditions.

### Pallet Fork

6702382

(30, 36, 42 & 48 inch teeth available)



Move bulky or bagged materials in one load. Hook on a pallet fork and move your bagged or bulk material fast. Ideal for all kinds of farm chores and fertilizer handling. In industrial plants and landscaping, handle baled or pallet materials.

### Stump Grinder (853H Only)

6707021

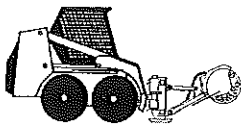

Remove stumps from hard to access areas. The stump grinding attachment is ideal for landscapers, rental yards and stump removal companies. Sideshift a full 50", cut 20" below grade and telescope 11" forward and backward, all from the operator's seat. The Bobcat Loader mounted stump grinder adds versatility and maneuverability, when compared to tow-behind stump cutters.

### Auger

Model 12 6704375  
Model 12H 6704371  
Model 20 6538563  
Model 20H 6704383

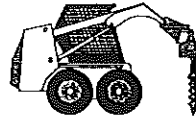

Dig 6" - 36" holes with speed and plumbline accuracy. Utilizing Bobcat Loader hydraulics, the heavy-duty hydraulic auger bites in with low speed, high torque power. Because of a unique knuckle-joint design, the auger will dig vertical holes even though the Bobcat Loader is working on uneven terrain.

### Industrial Fork Grapple

- 66 inch 6706305



The Fork Grapple is perfect for handling irregular-shaped metal and other assorted scrap and heavy-duty agricultural applications.

### Hydraulic Breaker

Model 2560 6706179  
Model 3500 6538972



Up to 500 ft.-lb. impact energy class. Backhoe or loader mounting. 2-position loader mounting frame for vertical and horizontal breaking. Quick-change tool system - variety of tools available. Low recoil operating cycle.

\*SPECIAL APPLICATIONS KIT WHICH INCLUDES A 1/2 INCH LEXAN FRONT DOOR WITH 1/4 INCH TOP AND REAR WINDOWS MUST BE USED WHEN OPERATING THE BOB-TACH MOUNTED HYDRAULIC BREAKER.

### Wheel Saw (853H Only)

WS12 6705615  
WS18 6705616

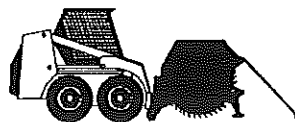

Precise cuts through concrete, asphalt, rebar or frozen ground. Excellent for a variety of road repair or utility applications. Two models for 12- or 18-inch cutting depths. Hydraulic depth and sideshift controlled from the operator's seat.

### Trencher

LT204 6704204  
LT405 (853H Only) 6707051

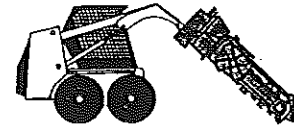

Versatile trenching ability. Use these Bobcat trencher attachments for a variety of jobs. The LT204 digs two or three feet deep and 4 to 12 inch trenching widths. The LT405 digs three to five feet deep and 5 to 12 inches wide. Hydraulic sideshift to get close to walls. Optional trench cleaner.

### Utility Fork/Grapple

- 60 inch 6704311  
- 66 inch 6704312  
- 72 inch 6706241  
Farm Grapple 6704788



Cut down on daily hand chores and free up your time. The Bobcat Loader Utility Fork and Grapple is the ideal attachment for handling bundled material, loose straw, and manure.

### Tiller

6662801

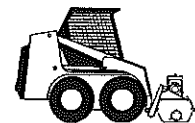

Till and mix for seed or sod bed preparation. The Bobcat Tiller attachment is great for jobs such as breaking up clumps and mixing compost or other materials into existing soil. The Bobcat Tiller features:

- \* 52-inch working width.
- \* Tills at a maximum 6-inch depth.
- \* Bi-directional rotation allows the loader to be driven forward or in reverse.

Some attachments may not be available from your local dealer.

## MELROE COMPANY APPROVED ATTACHMENTS & ACCESSORIES (Cont'd)

### Box Scraper

Approved by Melroe Company &  
Sold through Bobcat Loader Dealers

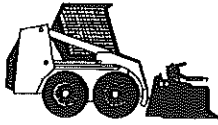

Grade, scarify, backfill or level. With this tool, a Bobcat Loader operator can grade, scarify, backfill or level in close quarters. Use it on road construction, lawn leveling, ripping hard packed soil or gravel, piling and leveling dirt, manure or other materials. Drag a load or doze it right where you need it.

### Longwood Grapple

Approved by Melroe Company &  
Sold through Bobcat Loader Dealers

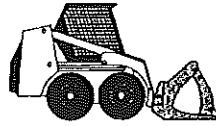

Turn your Bobcat Loader into a high performance log handler. The Longwood Grapples are made of high quality steel providing strength and durability for rough working conditions.

\*SPECIAL APPLICATIONS KIT WHICH INCLUDES A 1/2 INCH LEXAN FRONT DOOR WITH 1/4 INCH TOP AND REAR WINDOWS MUST BE USED WHEN OPERATING THE BOB-TACH MOUNTED HYDRAULIC BREAKER.

### Bale Handler

Approved by Melroe Company &  
Sold through Bobcat Loader Dealers

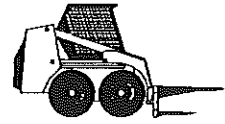

Manage large round bales easily with the Bale Handler. It's a handy and efficient way to move bales from the ground onto a trailer or into a bale feeder. The Bale Handler can be replaced with other attachments quickly, thanks to the Bob-Tach™ mounting system.

### Snow Blower

Approved by Melroe Company &  
Sold through Bobcat Loader Dealers

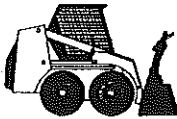

Blow snow with this perfect winter clean-up tool. Blow snow off driveways, sidewalks or in those tight quarters where only a Bobcat skid-steer loader can manage. Powered from the Bobcat Loader auxiliary hydraulics. Rotational spout directs snow where you want it to go.

### Tree Transplanter

Approved by Melroe Company &  
Sold through Bobcat Loader Dealers

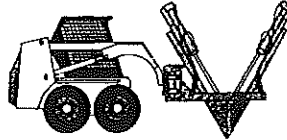

Turn your Bobcat Loader into a tree transplanter. The Tree Transplanter will dig trees and also load them on a truck or trailer in minutes. It's simple to operate with complete control from the operator's seat.

### Angle Blade

Approved by Melroe Company &  
Sold through Bobcat Loader Dealers

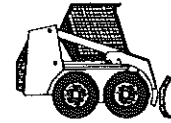

Remove heavy snow from the surface, before it's compacted. It's the ideal attachment for cleaning sidewalks, driveways, parking lots, alleys, service stations and warehouse lots. Use a heavy duty version for dozing and backfilling dirt.

### Rake

Approved by Melroe Company &  
Sold through Bobcat Loader Dealers

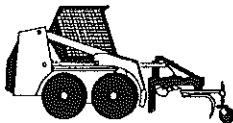

Turn your Bobcat Loader into a versatile landscape machine. The triple-duty Rake rips up soil with scarifier teeth, blades down high spots and fills holes, and rakes the surface to remove big rocks and debris.

### Tracks

Approved by Melroe Company &  
Sold through Bobcat Loader Dealers

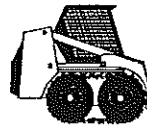

You'll get better performance in sand, snow and mud. Float over soft, sandy, or muddy ground and get better traction on slippery surfaces with over-tire metal or rubber tracks.

### Demolition Shear

Approved by Melroe Company &  
Sold through Bobcat Loader Dealers



Turn your Bobcat loader into a demolition contractor's dream! The LaBounty Shear cuts through a variety of materials such as rebar, scrap metal, concrete, pipe, etc. The 360° rotation capability allows the shear to work in a variety of positions.

\*SPECIAL APPLICATIONS KIT WHICH INCLUDES A 1/2 INCH LEXAN FRONT DOOR WITH 1/4 INCH TOP AND REAR WINDOWS MUST BE USED WHEN OPERATING THE BOB-TACH MOUNTED HYDRAULIC BREAKER.

Some attachments may not be available from your local dealer.

**NOTE: Use of unapproved attachments and unapproved machine modifications will void contracts and warranties and must conform to all local, state, federal and global regulations.**

**ATTACHMENTS & ACCESSORIES (Cont'd)**

**STANDARD OPERATOR CAB ENCLOSURE PANELS**

(Includes Front Door W/Wiper, Top and Side Windows)

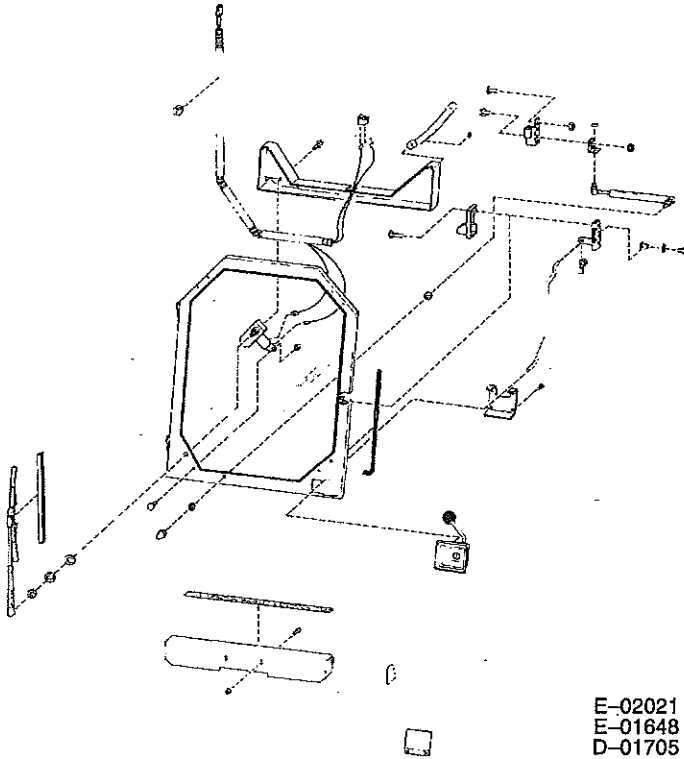

E-02021  
E-01648  
D-01705

**SUSPENSION SEAT**

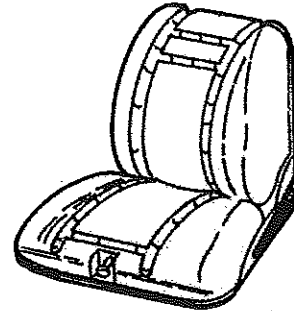

D-01897

**SPECIAL APPLICATIONS KIT\***

(Includes 1/2 inch Lexan Front Door & 1/4 inch Lexan Top and Rear Windows)

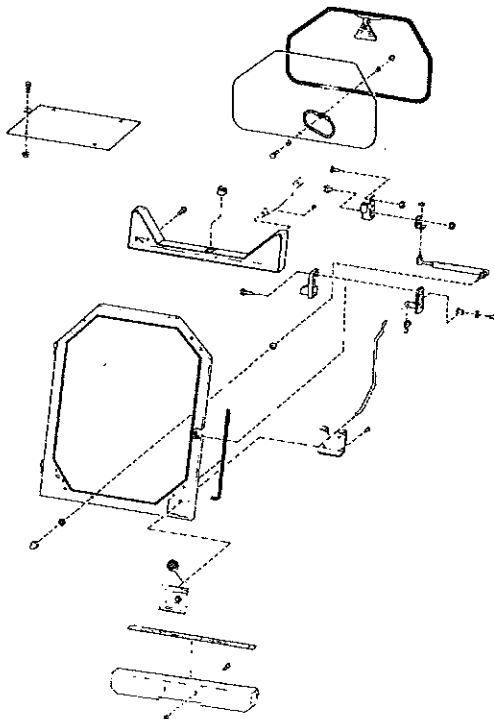

E-02022

\*USED TO PREVENT OBJECTS FROM ENTERING THE OPERATOR CAB





**ADDITIONAL PUBLICATIONS**

The following publications are also available for your Bobcat Loader. You can order them from your Bobcat dealer.

**SKID STEER LOADER  
OPERATOR  
TRAINING COURSE  
6722720**

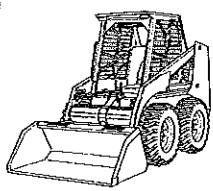

-Introduces operator to step-by-step basics of Skid-Steer loader operation. Also available in Spanish P/N 6724036.

<b>8</b>	 <b>Operation &amp; Maintenance Manual</b>
<b>5</b>	
<b>3</b>	
	
 	

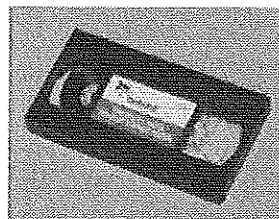

**OPERATION &  
MAINTENANCE  
MANUAL  
6722906**

-complete instruction on the correct operation and the routine maintenance of the BOBCAT loader.

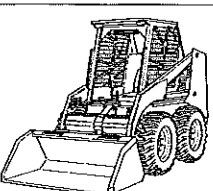

**SAFETY  
VIDEO  
6724793**

-provides basic safety instructions.

<b>8</b>	 <b>Service Manual</b>
<b>5</b>	
<b>3</b>	
	
 	



**SERVICE  
MANUAL  
6720755**

-complete maintenance and overhaul instructions for your BOBCAT loader.



**SAFETY  
MANUAL  
6556500**

-provides basic safety procedures and warnings for your BOBCAT loader. Also available in Spanish P/N 6724451.

 <b>OPERATOR'S HANDBOOK</b>
 <b>WARNING</b>
<ul style="list-style-type: none"> <li>• _____</li> <li>• _____</li> <li>• _____</li> <li>• _____</li> <li>• _____</li> <li>• _____</li> <li>• _____</li> </ul>

**OPERATOR'S  
HANDBOOK  
6723728**

**6700986  
(853H Plus - 5103  
853 Plus - 5102)  
6704762  
(853 Base - 5101)**

-gives basic operation instruction and safety warnings.

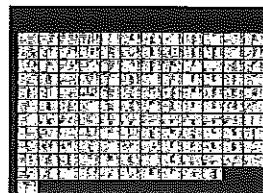

**PARTS  
MICROFICHE**

-Up-to-date PARTS information is also available. See your BOBCAT dealer.



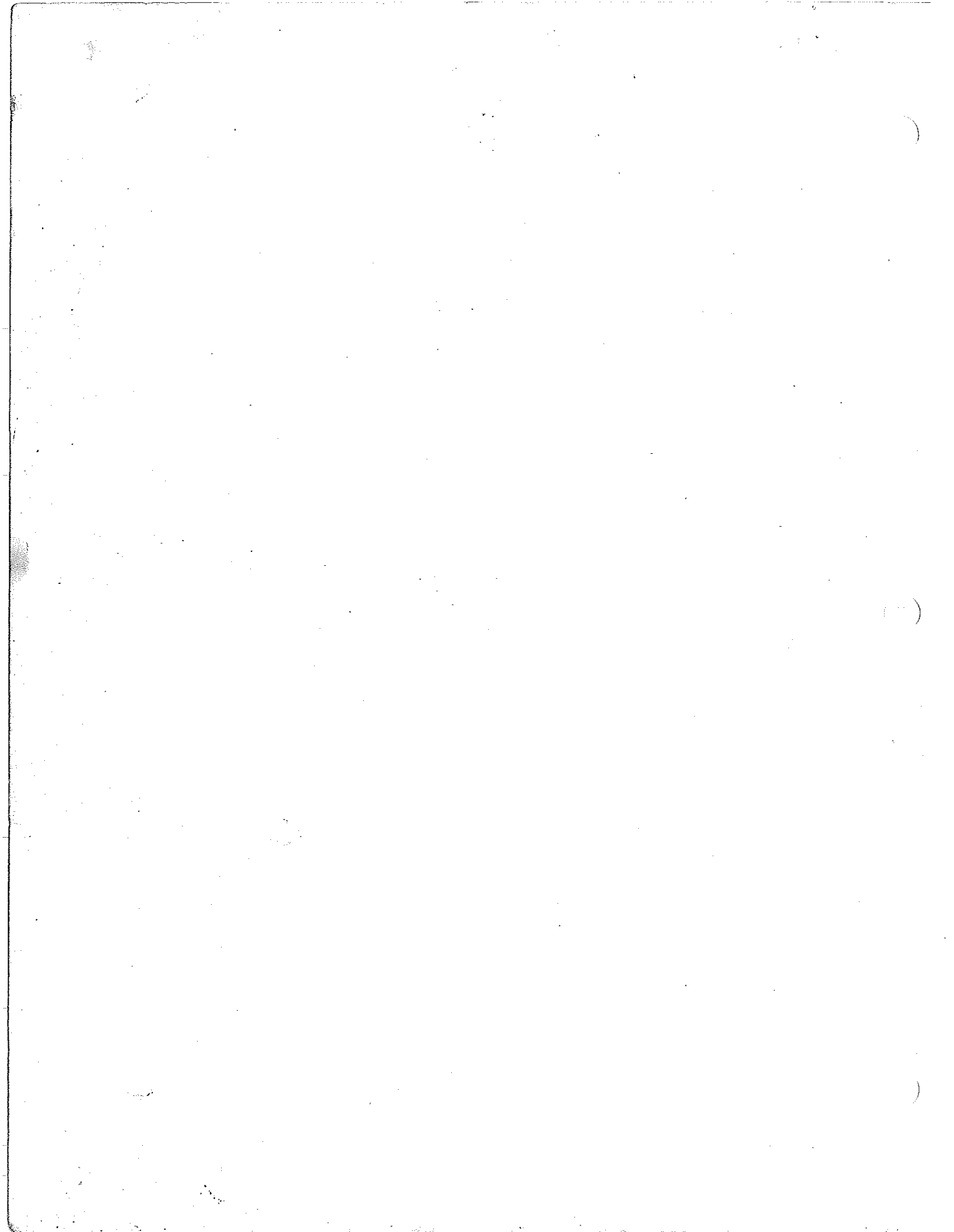

# **WARRANTY**

## **400-900 Series Bobcat Loaders**

The Melroe Company warrants to its authorized dealer and authorized dealers of Melroe Equipment, Ltd., who in turn warrants to the original buyer (owner) that each new Bobcat Loader will be free from proven defects in material and workmanship for 12 months after delivery to the owner.

During the warranty period, the authorized selling Melroe dealer shall repair or replace, at his option, without charge for parts and labor, any part of the Melroe product which fails because of defects in material and workmanship. The owner shall provide the authorized dealer with prompt written notice of the defect and allow reasonable time for replacement or repair. Melroe may, at its option, request failed parts to be returned to the factory. Travel time of mechanics and transportation of the Melroe product to the authorized Bobcat Loader dealer for warranty work are the responsibility of the owner.

The warranty does not apply to tires or other trade accessories not manufactured by Melroe. The owner shall rely solely on the existing warranty, if any, of the respective manufacturers thereof. Warranty does not cover replacement of scheduled service items such as oil, filters, tune-up parts, and other high-wear items. The warranty does not cover damages resulting from abuse, accidents, alterations, air flow obstructions, or failure to maintain or use the Melroe product according to the instructions applicable to it.

**THIS WARRANTY IS IN LIEU OF ALL OTHER WARRANTIES (EXCEPT THOSE OF TITLE), EXPRESSED OR IMPLIED, AND THERE ARE NO WARRANTIES OF MERCHANTABILITY OR FITNESS FOR A PARTICULAR PURPOSE. IN NO EVENT SHALL THE AUTHORIZED SELLING DEALER OR MELROE BE LIABLE FOR DOWNTIME EXPENSES, LOSS OF MACHINE USE OR OTHER INCIDENTAL, CONSEQUENTIAL OR SPECIAL DAMAGES.**

**MELROE**  

---

**INGERSOLL-RAND**

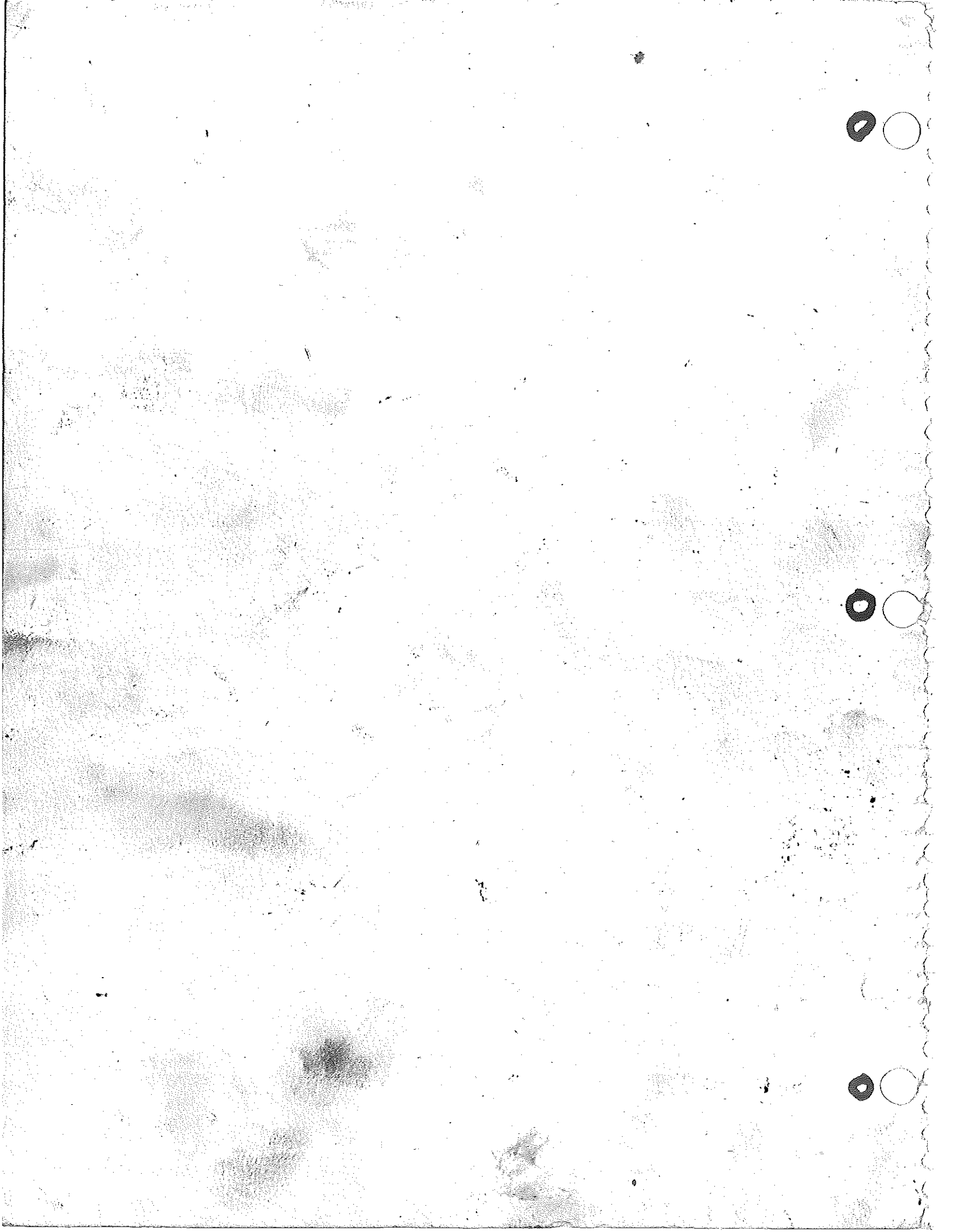



**Bobcat**

**PALLET FORK ATTACHMENT**



***One Tough Animal™***



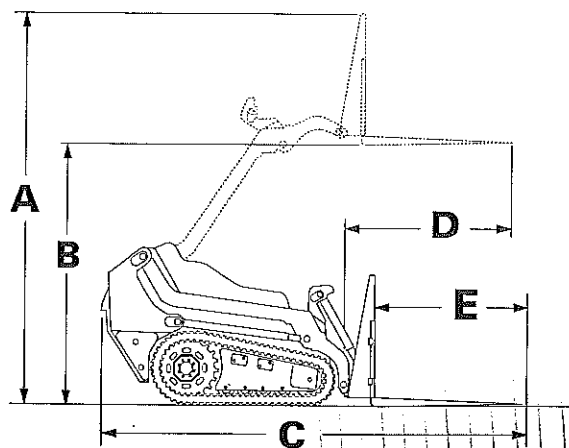
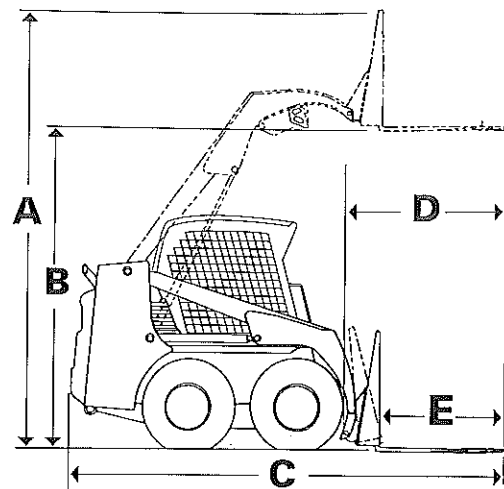
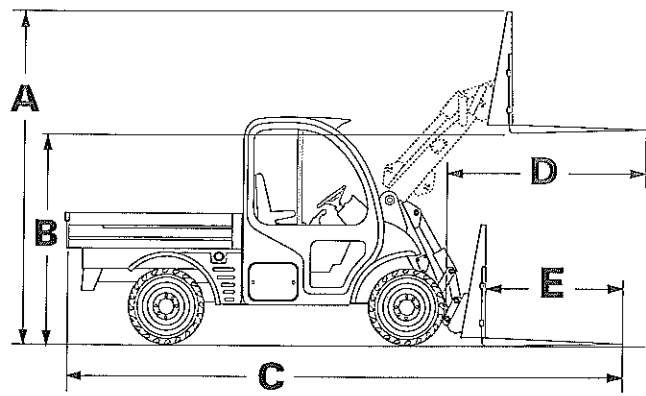

# Bobcat® Pallet Fork

## Specifications

### PALLET FORK SPECIFICATIONS

Frame	Frame Width	Frame Height	Frame Weight	Tooth Length	Tooth Wt. (set of 2)	Total Weight
Small	37 in.	34.5 in.	105 lb.	30 in.	130 lb.	235 lb.
				36 in.	147 lb.	252 lb.
Standard	46 in.	39 in.	200 lb.	30 in.	130 lb.	330 lb.
				36 in.	147 lb.	347 lb.
				42 in.	164 lb.	364 lb.
Heavy-Duty	60 in.	49 in.	470 lb.	48 in.	214 lb.	684 lb.
				48 in.	238 lb.	708 lb.

### SMALL PALLET FORK (with 36 in. teeth)

Loader Size	A	B	C	D	E
MT52	101 in.	66 in.	110 in.	45 in.	36 in.
MT55	101 in.	66 in.	113 in.	51 in.	36 in.
463	124 in.	90 in.	120 in.	40 in.	36 in.

### HEAVY-DUTY PALLET FORK (with 48 in. teeth)

Loader Size	A	B	C	D	E
S220	167 in.	117 in.	169 in.	70 in.	48 in.
S250*	173 in.	123 in.	169 in.	78 in.	48 in.
S300*	171 in.	123 in.	172 in.	78 in.	48 in.
S330	171 in.	123 in.	172 in.	77 in.	48 in.
A300*	171 in.	123 in.	172 in.	78 in.	48 in.
T250	166 in.	117 in.	169 in.	70 in.	48 in.
T300/T320*	173 in.	123 in.	169 in.	78 in.	48 in.

### PALLET FORK RATINGS (Small)

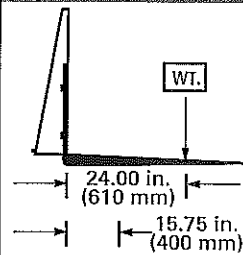
	Loader Rated Operating Capacity		Pallet Fork Load Rating at 15.75 in.	
		500 lb.	(230 kg)	260 lb.
	600 lb.	(270 kg)	350 lb.	(160 kg)
	700 lb.	(320 kg)	440 lb.	(200 kg)

### PALLET FORK RATINGS (Standard)

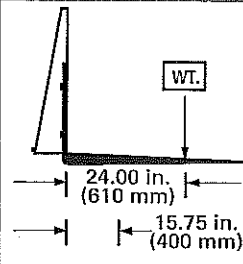
	Loader Rated Operating Capacity		Pallet Fork Load Rating at 24 in.	
		950 lb.	(430 kg)	410 lb.
	1200 lb.	(540 kg)	660 lb.	(300 kg)
	1300 lb.	(590 kg)	770 lb.	(350 kg)
	1500 lb.	(680 kg)	950 lb.	(430 kg)
	1700 lb.	(770 kg)	1120 lb.	(510 kg)
	1900 lb.	(860 kg)	1270 lb.	(580 kg)
	2100 lb.	(950 kg)	1380 lb.	(630 kg)
	2300 lb.	(1040 kg)	1500 lb.	(680 kg)
	2500 lb.	(1130 kg)	1560 lb.	(710 kg)

### PALLET FORK RATINGS (Heavy Duty)

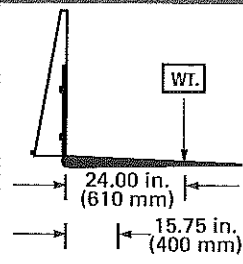
	Loader Rated Operating Capacity		Pallet Fork Load Rating at 24 in.	
		2000 lb.	(910 kg)	1300 lb.
	2200 lb.	(1000 kg)	1430 lb.	(650 kg)
	2400 lb.	(1090 kg)	1560 lb.	(710 kg)
	2600 lb.	(1180 kg)	1690 lb.	(770 kg)
	2800 lb.	(1270 kg)	1820 lb.	(830 kg)
	3000 lb.	(1360 kg)	1950 lb.	(880 kg)
	3200 lb.	(1450 kg)	2080 lb.	(940 kg)
	3400 lb.	(1540 kg)	2210 lb.	(1000 kg)
	3600 lb.	(1630 kg)	2340 lb.	(1060 kg)

### STANDARD PALLET FORK (with 48 in. teeth)

Loader Size	A	B	C	D	E
553	137 in.	98 in.	142 in.	55 in.	48 in.
S100	137 in.	98 in.	—	58 in.	48 in.
S130	142 in.	103 in.	150 in.	61 in.	48 in.
S150/S160	148 in.	109 in.	156 in.	57 in.	48 in.
S175/S185	151 in.	113 in.	158 in.	67 in.	48 in.
S205	151 in.	112 in.	156 in.	68 in.	48 in.
S220	156 in.	116 in.	169 in.	62 in.	48 in.
S250*	156 in.	123 in.	169 in.	70 in.	48 in.
T140	143 in.	104 in.	150 in.	61 in.	48 in.
T180	151 in.	109 in.	156 in.	57 in.	48 in.
T190	151 in.	112 in.	158 in.	68 in.	48 in.
5600-C	117 in.	77 in.	202 in.	79 in.	48 in.
5600-D	117 in.	79 in.	202 in.	78 in.	48 in.

\*Dimensions A and B will be 2 inches less on machines older than K-series

