

Operator Manual



CROWN

TSP

You Must be Trained

WARNING

It's the law, you must be trained and certified to operate this truck. (OSHA § 1910.178, Rev. 1999)

You or others around you can be seriously injured or even killed if you don't use this truck correctly.

Read and obey all warnings and instructions in this Manual* and on the truck.

Falling from a platform can cause serious injury or death. **Put on the operator harness and attach lanyard when elevated and working with an open side gate or with the narrow front rail option.**

Head, arms, hands, legs or feet outside the operator area can be pinned or crushed whenever the truck is moving. Stay within the operator area and **stop the truck completely before getting off.**

A dockboard can move or drop while you are on it. Or you could drive off a dock. Falls from docks or dockboards can cause serious injury or even death. **Make sure you are safe.**

Inspect your truck before starting work, make sure it is in good working order.

* Additional copies of this Operator Manual and all Truck Labels can be obtained from Crown Equipment Corporation, New Bremen, Ohio 45869 U.S.A.

All rights reserved under International and Pan American copyright conventions
Copyright 2007 Crown Equipment Corp.

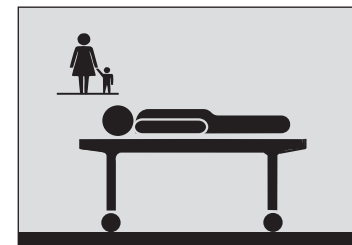
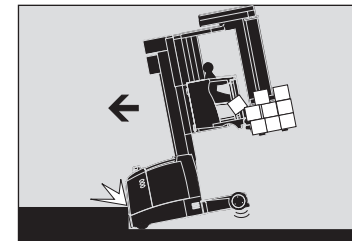

IT'S THE LAW, YOU MUST BE TRAINED AND CERTIFIED

Federal law states that only properly trained operators are permitted to operate a powered industrial truck and that your employer must train you and certify that you are qualified to operate this powered industrial truck. (OSHA §1910.178, Rev. 1999)

Do not operate this truck in your work place until you have been trained and certified by your employer.

You could be killed or seriously injured if you are not adequately trained for lift truck operation!

Protect Yourself

! Know the Hazards

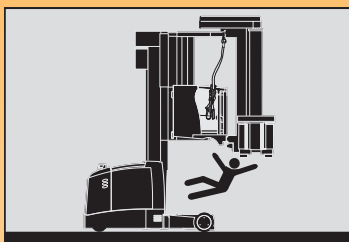

WEAR YOUR OPERATOR HARNESS

Falls from a platform can cause serious injury or even death.

- Use your operator harness and lanyard when elevated and working with an open side gate or with the narrow front rail option. Read the warnings on the harness.
- Check your harness and lanyard. Replace them if they have ever been used to stop a fall, or if damaged or worn.

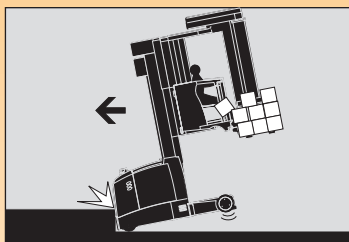

LOOK WHERE YOU'RE DRIVING

- If you run into things you can be injured. You could fall from the truck or the load could shift and hit you. Make certain there is nothing in your path, on the floor or sticking out of the racks.
- Always be alert to the area around you and watch where you are driving. You could be pinned or crushed by objects intruding or poking into the operator area.

DRIVE CAREFULLY

- Keep your hands on the controls and feet on the pedals. Keep your entire body in the operator area. A foot or hand caught between the truck and a fixed object will be crushed or even cut off.
- Keep your truck under control at all times. Drive at a speed that allows you to stop safely. Be even more careful on slippery or uneven surfaces. Do not drive over objects on the floor.

CHECK YOUR LOADS

- Before you pivot a load, make certain it won't intrude or poke into the operator area. Do not handle long, wide or unstable loads. Check clearances before using traverse.

! Know the Hazards

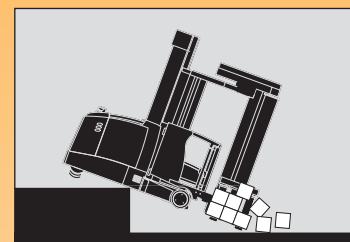

AVOID FALLS AND TIPOVERS

Tipovers are very serious accidents, you can be crushed or even killed. The best way to prevent injury is to know where you are at all times and follow the rules of safe truck operation. There is no sure way to avoid injury during a tipover or a drop from a dock.

- Be careful if driving around docks or ramps. Stay away from the edge. Watch where you're going.
- When traveling out of the aisle, keep the forks or load close to the ground. Watch for overhead obstructions. Perform all truck movements smoothly and at a speed that will give you time to react in an emergency.
- Turret Stockpickers should not be used on ramps or grades. If you must drive on a grade, travel slowly and don't turn. If carrying a load, point the forks upgrade. If unloaded, point the forks downgrade.
- An unloaded truck can also tip over. Be just as careful using an unloaded truck as you are using a loaded one.



USE YOUR TRUCK SAFELY

- Keep hands and feet away from all moving parts such as the load handler, masts or wheels. Don't sit or stand on the side gates.
- Never stand on or under the forks, or allow anyone else to stand on or under them. Never allow passengers on the truck. There is no safe place for them.
- Before you leave your truck:
 - Come to a complete stop.
 - Lower the forks to the floor.
 - Shut the truck off with the key switch.

Warning	1
You Must be Trained	2
Protect Yourself	3
Contents	5
What's in it for You?	6
Your Turret Stockpicker	7
Turret Truck Parts	9
Capacity & Load Center	11
Capacity Plate	13
Display Panel	15
Power On & Off	17
Sit or Stand Operation	18
Braking	19
Platform Safety	21
Traverse & Pivot	23
Raise & Lower	25
Steering & Travel	27
Traveling & Plugging	29
Wire Guidance Option	31
Daily Safety Check	33
Be a Safe Driver	35
Battery Maintenance	39
Warning Labels	42

WHAT'S IN IT FOR YOU?

The better you understand your truck and how to use it, the better and safer operator you can be. Here are some guides to using this manual.

Capacity & Load Center

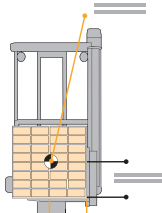

WHAT IS YOUR TRUCK CAPACITY?
Capacity is the load (including pallet or container) that can be lifted to a given height at a given load center. See the capacity plate on your truck. Make certain you use the correct units of measure.

WHAT IS LOAD CENTER?
Load center is the distance from the faces of the forks to the center of an evenly distributed load.

LOADS MUST BE EVENLY DISTRIBUTED
Your truck could tip over, in any direction, if a load is placed or shifted to the front, back or side of a pallet or container

Know the Hazards

KNOW YOUR LOAD
Do not exceed the capacity shown on your truck's capacity plate. Be careful when handling long, high or wide loads. Do not handle unstable loads.

EXCEEDING TRUCK CAPACITY CAN CAUSE AN ACCIDENT
Know the capacity of your truck as shown on your capacity plate. Make certain you use the correct units of measure. Pay attention to:

- Weight of load
- Load center
- Lift height

HYDRAULIC OPERATIONS CAN AFFECT STABILITY
Be careful when using operations such as traverse, extend or pivot. Remember that anytime the forks move, the load moves also. This can affect stability. Perform all operations smoothly.

CENTER THE LOAD
Your truck could tip over if a load is placed to the front, back or side of a pallet or container. Make sure your load is evenly distributed centered over the forks.

SAMPLE

Capacity & Load Center

QUICK LOCATORS

In addition to the "Contents" page you can use page headings to find topics. Some pages also have a picture of the truck in the corner showing features or functions covered on that page.

"KNOW THE HAZARDS"

Watch for and read these special blocks. You will find information about possible safety hazards and how to avoid them.

HOW-TO-DRAWINGS

On many pages you will find pictures as well as text to help you understand how to use your truck safely and productively.

Your Turret Stockpicker

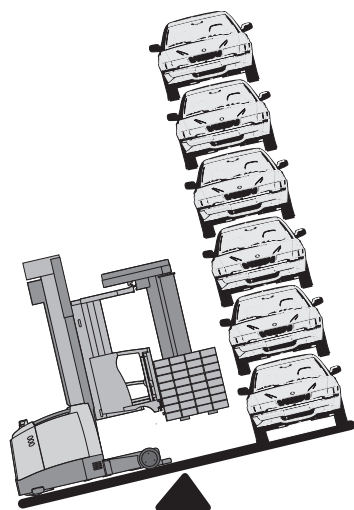

TURRET STOCKPICKERS

Your turret truck is designed to transport, stack and retrieve loads.

YOUR TURRET TRUCK IS NOT AN AUTOMOBILE

With a load it may weigh more than 6 automobiles.

- You don't steer the same.
- You don't brake the same.
- You don't accelerate the same.

HOW TO DRIVE YOUR TRUCK

Put the side gates down. Keep your hands and feet inside the operator compartment and on the controls. Look in the direction you're going.

WHEN TO USE THE HARNESS AND LANYARD

Wear your harness and attach the lanyard whenever the operator compartment is elevated and you have a side gate open. (The harness may be either a belt or a full body harness, depending on company and state requirements.) See chart below.

Wear your harness and lanyard at all times if your truck has a narrow front rail option.

GIVE YOUR BODY A BREAK

Take advantage of stop time. Flex your arms and legs. Staying alert will help you be a better and safer driver.

FALL PROTECTION/PREVENTION SELECTION CHART

Fall Protection Devices	Operator Weight kg (lbs.)					
	Less than 100 kg (220 lbs.)	100 - 140 kg ¹⁾ (220 - 310 lbs.) ¹⁾	141 - 181 kg ¹⁾ (311 - 400 lbs.) ¹⁾	182 - 222 kg ¹⁾ (401 - 490 lbs.) ¹⁾	223 - 263 kg ¹⁾ (491 - 580 lbs.) ¹⁾	264 - 304 kg ¹⁾ (581 - 670 lbs.) ¹⁾
Body Belt	X					
Full Body Harness		X	X	X	X	X
Energy Absorber - max total length 1.8m (6ft)			X	X		
Self-Retracting Lanyard - max total length 2.4m (8ft)	X	X			X	X ²⁾

1) Truck capacity shall be reduced by the operator(s) weight in excess of 100kg (220 lbs)

2) Self-Retracting Lanyard - shall be rated for the operator's weight. For operator weight over 140kg (310 lbs) - contact Crown.

BUILT TO STANDARDS

This truck was designed and built to current industry and government standards and guidelines. For more information see the following:

- American National Standards Institute (ANSI/ITSDF) B56.1 (Download free from www.itsdf.org)
- Occupational Safety and Health Act (OSHA) §1910.178, Rev. 1999 (Download free from osha.gov)
- Underwriters Laboratory (UL 583)
- National Fire Prevention Association (NFPA 505)



Hands on controls

Side gates down

Feet on pedals

Turret Truck Parts

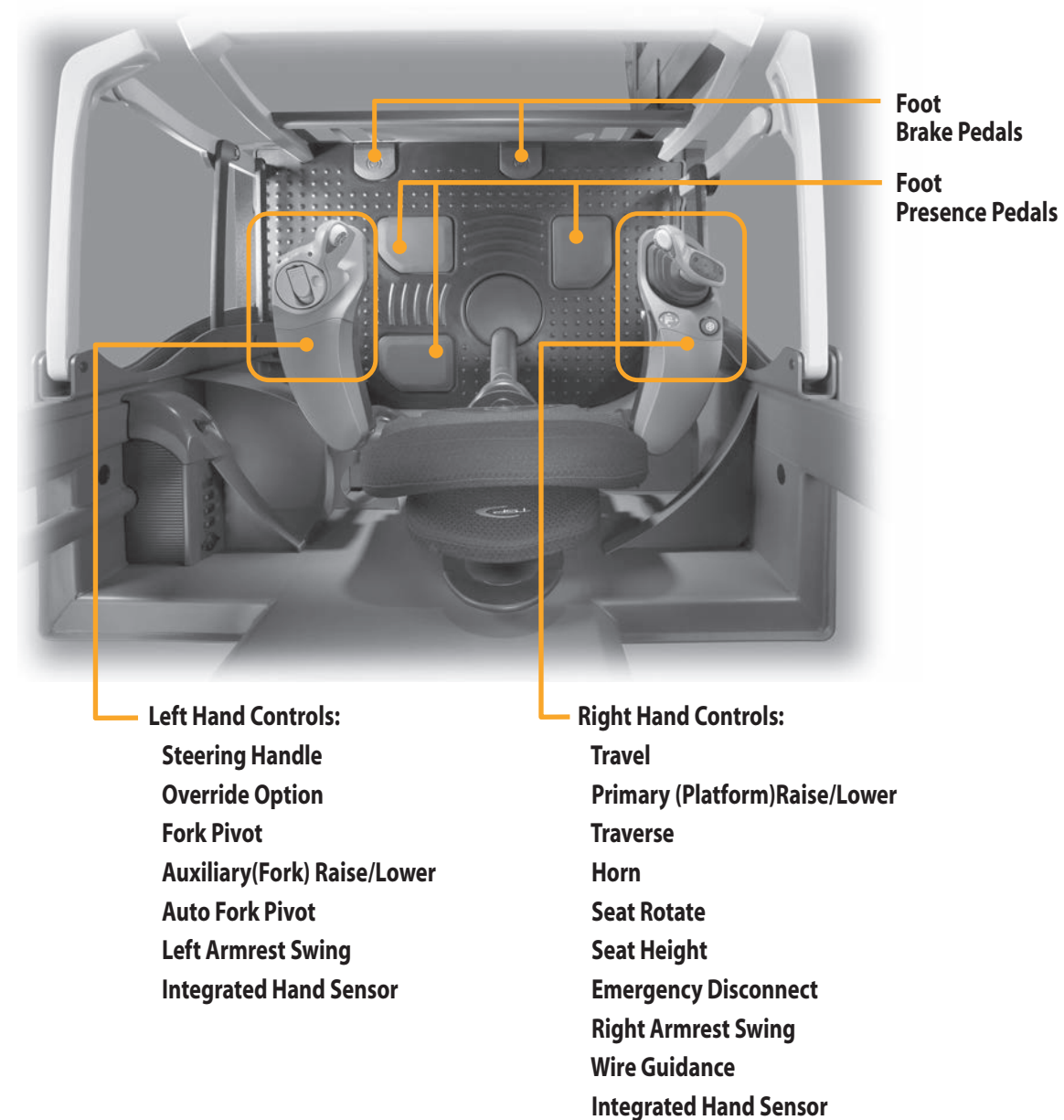
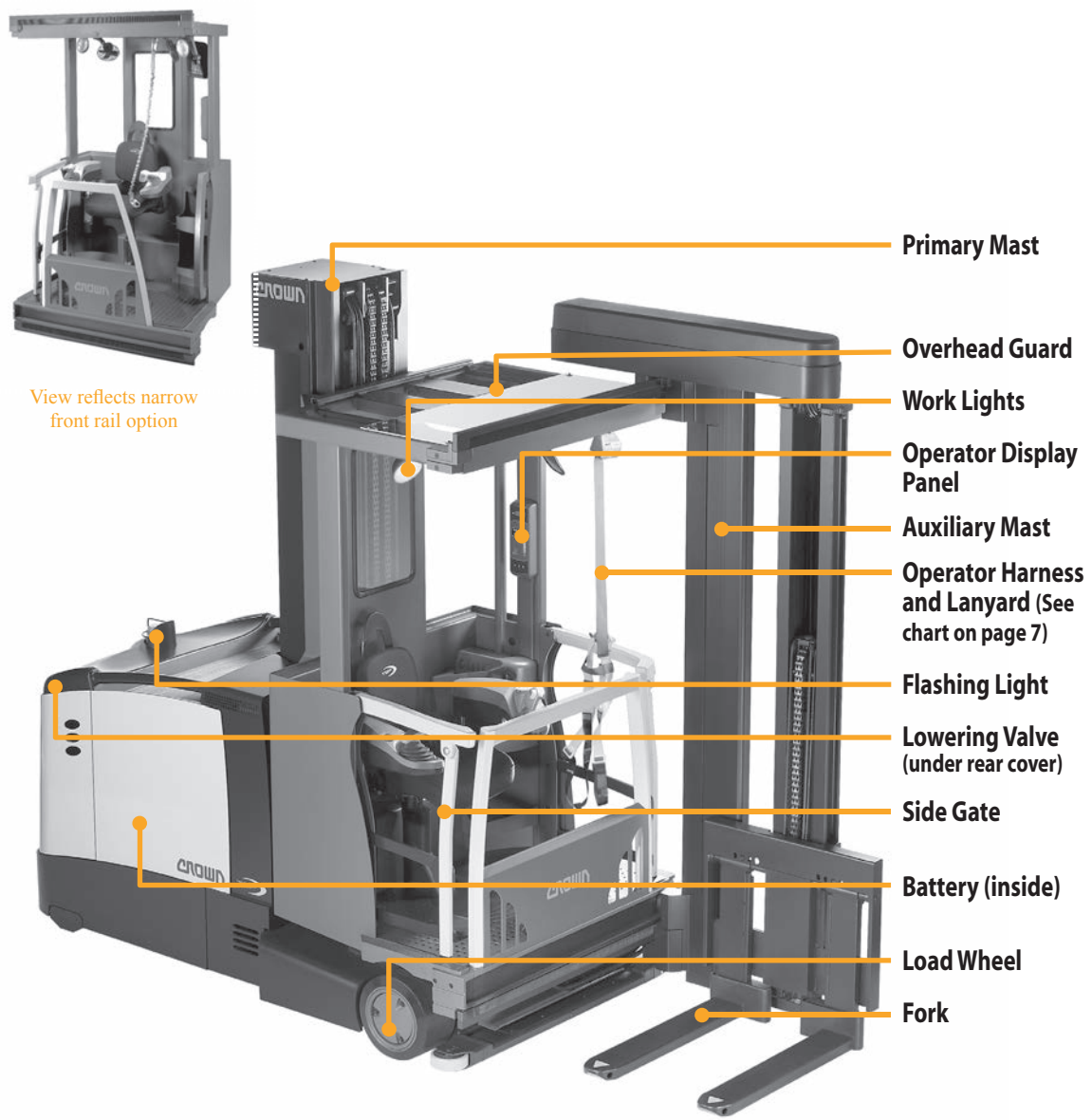

Capacity & Load Center

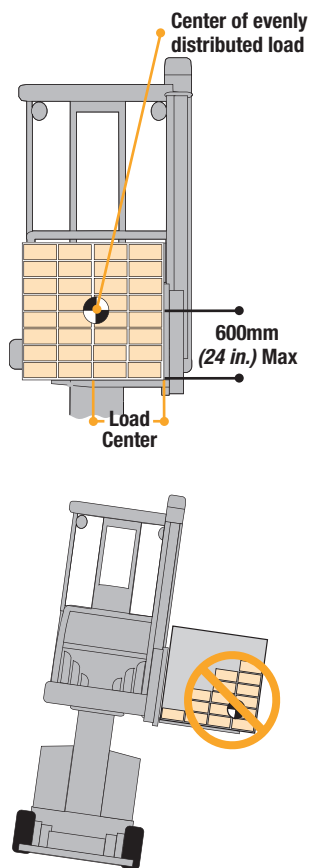

WHAT IS YOUR TRUCK CAPACITY?

Capacity is the load (including pallet or container) that can be lifted to a given height at a given load center. See the capacity plate on your truck. Make certain you use the correct units of measure.

WHAT IS LOAD CENTER?

Load center is the distance from the faces of the forks to the center of an evenly distributed load.

LOADS MUST BE CENTERED & EVENLY DISTRIBUTED

Your truck could tip over, in any direction, if a load is placed or shifted to the front, back or side of a pallet or container.

! Know the Hazards

Units of measure, kg/mm (lb/in)	
Truck Weight with Max. Battery	3715 (8193)
Truck Type	E
Attachment Data	PLATFORM
Serial Number	1A23456
Capacity with Mast Vertical	
Load Center (mm)	Capacity (kg/mm)
1125 (2500)	7010 (276)
1350 (3000)	6095 (240)
1575 (3500)	5180 (180)
1800 (4000)	4265 (150)
2025 (4500)	3350 (120)
2250 (5000)	2435 (90)

*Truck capacity must be reduced by operator weight in excess of 100kg (220 lb)

KNOW YOUR LOAD

Do not exceed the capacity shown on your truck's capacity plate. Be careful when handling long, high or wide loads. Do not handle unstable loads.

EXCEEDING TRUCK CAPACITY CAN CAUSE AN ACCIDENT

Know the capacity of your truck as shown on your capacity plate. Make certain you use the correct units of measure. Pay attention to:

- Weight of load
- Load center
- Lift height

HYDRAULIC OPERATIONS CAN AFFECT STABILITY

Be careful when using operations such as traverse, extend or pivot. Remember that anytime the forks move, the load moves also. This can affect stability. Perform all operations smoothly.

CENTER THE LOAD

Your truck could tip over if a load is placed or shifted to the front, back or side of a pallet or container. Make sure your load is evenly distributed and centered over the forks.

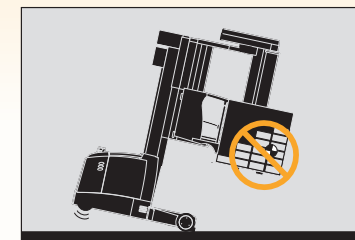

Capacity Plate



CAPACITY PLATE INFORMATION

The capacity plate is on the platform, above the operator display. It contains:

- Truck serial number
- Capacity information (load, load center and lift height)
- Truck type (a fire safety rating)
- Truck weight with battery (does not include load)
- Attachment information (if any)

OTHER LIFT HEIGHTS AND LOAD CENTERS

Contact Crown for capacities at lift heights or load centers not given on your capacity plate.

READING YOUR CAPACITY PLATE

Capacity may be reduced as lift height **A** increases. *For example: On the sample plate, 1360kg (3000 lb) can be lifted to 8000mm (315 in). But above 8000 (315), to 9220 (363), capacity is reduced from 1360 (3000) to 1180 (2600).*

Capacity is reduced as load center **B** increases. *For example: On the sample plate, 1360kg (3000 lb) can be lifted if the load center is 600mm (24 in). But if the load center is increased to 865 (34), capacity is reduced from 1360 (3000) to 955 (2100).*

CAUTION

Truck capacity must be reduced by operator weight over 100kg (220lb). You may not increase capacity if load center is less than shown on your capacity plate.

Note: ANSI/ITSDF B56.1 requires that all data be shown first in Metric units and then USA units.

SAMPLE CAPACITY PLATE
The information shown on this sample plate does not apply to your truck.

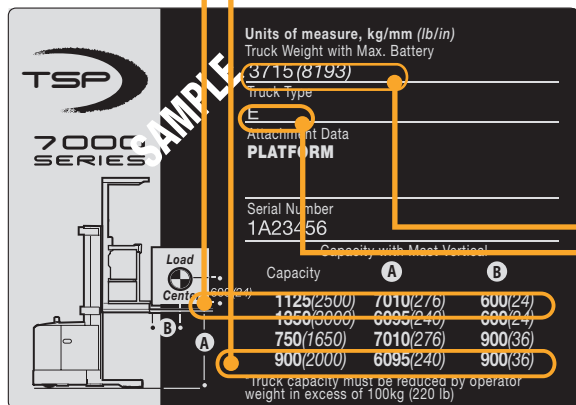

Know the Hazards

TRUCK WEIGHT

Some floors have limited capacity. Check your capacity plate for the weight of your truck. Remember to add the weight of the load you have on the forks. Make certain you use the correct units of measure.

TRUCK TYPE

Some truck types are not permitted in areas where there are fire hazards. Watch for marked areas. *For example: You must not drive a type E or ES truck into an area restricted to EE or EX trucks.*

Display Panel

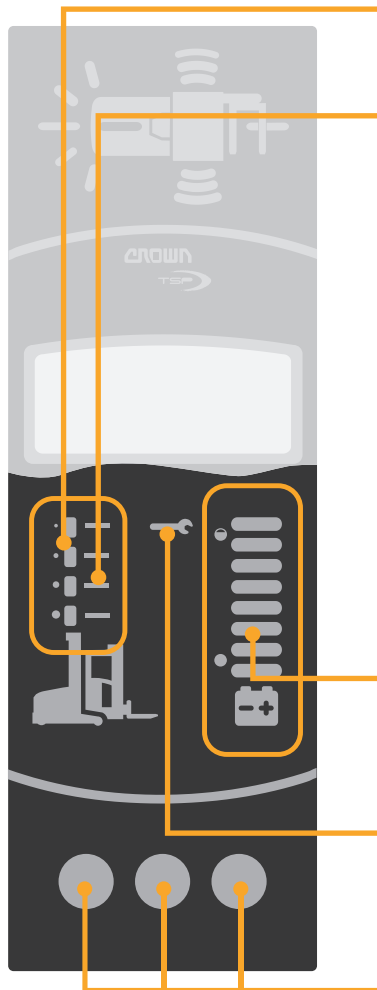
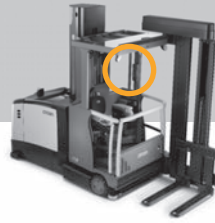

CAPACITY DATA MONITOR (see Caution)

- **Fork height limit lights:** The green bars will light to show how high, or to which lift zone you can raise the load.
- **Fork height lights:** A yellow bar will light to show which lift zone the forks are in. If any of these lights are on, it means the auxiliary mast is higher than the collapsed height of the primary mast. Make certain the load and auxiliary mast will clear any overhead obstructions.
- **Overload warning:** If load is too heavy for the lift zone the forks are in, the alarm will "beep" and message display will read **REDUCE LIFT HEIGHT**. Immediately lower the load.

Caution: All information displayed by the fork position lights and/or the Capacity Data Monitor is for reference only. You must always be alert to load center, load distribution, load height and load weight. You must also be aware when the load or auxiliary mast extends above the top of the primary mast, and how much overhead clearance is needed.

BATTERY CHARGE DISPLAY

The green bars show how much charge is left. A flashing yellow light means the battery needs to be changed or recharged.

SERVICE LIGHT

A yellow light means something needs to be serviced. Report the trouble to your supervisor, even if the truck seems to be working OK.

SERVICE & OPTION BUTTONS

See service manual.

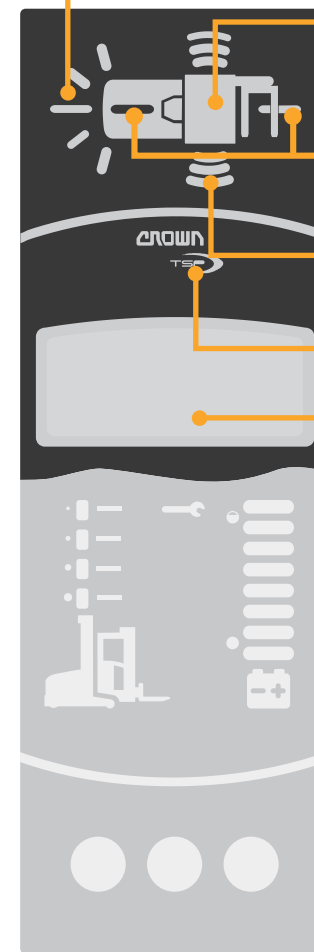

DRIVE WHEEL DIRECTION INDICATOR LIGHTS, see page 28

MANUAL STEERING LIGHT, OPTION

Red light means you are in manual steering mode. Take control of steering tiller.

GUIDANCE LIGHTS, OPTION

Green lights means you are in wire guided mode.

WIRE SIGNAL LIGHTS, OPTION

Amber lights means signal is weak. See message panel.

POWER ON LIGHT

MESSAGE PANEL

The upper half of the message panel is continually updating fork height, load on forks and battery charge remaining.

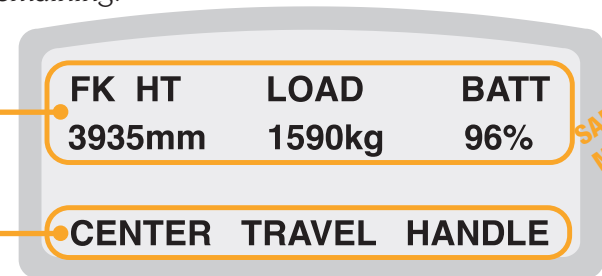

The bottom line of the message panel will usually show time and date. However if truck status or operation requires your attention, instructions will be displayed here.

Anytime you hear a beep, or if the truck slows down or won't work, check message panel for instructions.

Power On & Off



KEY SWITCH

- Turn the key clockwise as far as it will go, to the TEST position. Check that the alarm and all indicator lights are working.
- Let go of the key and it will return to the ON position.
- Turn the key back to the OFF position to shut the truck off. Always turn the key to OFF when leaving the truck.

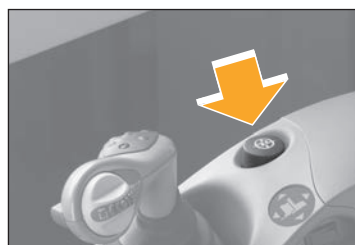

EMERGENCY DISCONNECT

Anytime the truck isn't working right, first stop the truck and then press the emergency disconnect to cut power to all truck functions, including steering.

Don't use the truck. Report the problem to your supervisor.

Turn the key switch to OFF and back to ON to reconnect the battery and reset the emergency disconnect button.

Sit or Stand Operation

SIT/STAND OPTION

You can drive while seated, with the seat in one of four locked positions. Or, with the seat locked in the straight ahead position, flip the seat up to drive while standing.

Braking and foot presence pedal operation is not the same for the two operating positions. See pages 19, 20 & 22.

SEAT ADJUSTMENTS

- Pull the release arm under the right armrest to move the seat up or down.
- Press the trigger on the front of the right multi-task handle, and rotate the seat until it locks in one of the four positions.



SIDE SIT ADVANTAGES

The side facing seat position gives you the best view for driving power unit first. A faster travel speed is also available with the seat in this position.



ARMREST ADJUSTMENT

You can swing each armrest to the most comfortable operating position, or to make it easier to get on or off the truck.

Press the button on the inside of the armrest to release and swing the armrest.

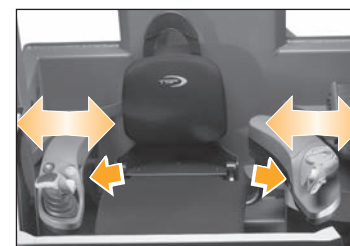

Braking

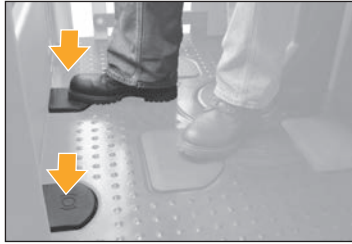

BRAKE PEDAL BRAKING WHEN SEATED

When seated step down on either of the front pedals to apply the brake.

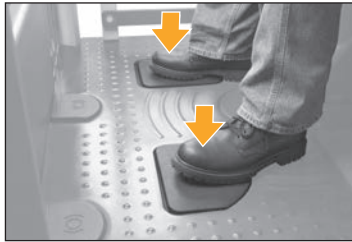

PRESENCE PEDAL BRAKING WHEN STANDING

In the standing position only, the brake will be applied if you remove either foot from a presence pedal.

Note: When in the seated position, the truck will coast if you remove either foot from a presence pedal. You can stop the truck with the brake pedals or by plugging (see page 29).

Know the Hazards



MAKE SURE YOUR BRAKES WORK

Test your brakes at the start of each shift. Know the distance it takes to stop before you start working. If the stopping distance is too long for you to stop safely, don't drive the truck. Report any problem to your supervisor.

SEATED VS STANDING OPERATION

Braking and presence pedal operation is not the same for the two operating positions. Make certain you understand all operations and stay alert, especially when changing operating positions.

Platform Safety



KEEP THE SIDE GATES DOWN

- Keep the side gates down unless you are leaving the truck, or required to pick from the side. The truck will not operate with a gate up.
- Don't leave the platform when it is elevated.
- Don't sit or climb on the side gates.
- Keep your entire body in the operator area.

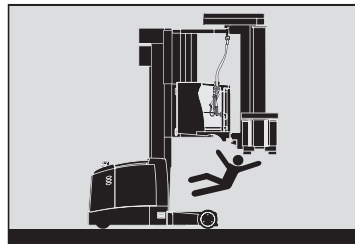

HARNES AND LANYARD

Use your harness and lanyard whenever you are working from a raised platform and have a side gate open.

Note: Trucks equipped with the narrow front rail option have only a right side gate. The harness and lanyard must be worn at all times.

Check the harness, lanyard, snap hooks, and mounting points daily for wear or breakage. If it doesn't look safe don't use the truck. Report the problem to your supervisor.



HAND SENSORS

You must have a hand on each of the multi-task controls for the following load handling functions:

- To initiate platform lift
- Auxiliary raise or lower
- Traverse & extend/retract
- Pivot (manual & auto)

You must have a hand on the right multi-task control for the following to operate:

- Travel
- Platform raise or lower

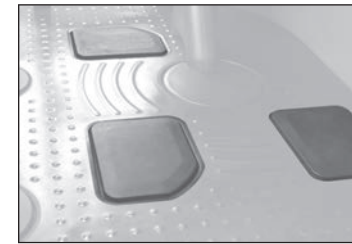

FOOT PRESENCE PEDALS

Whether sitting or standing, you must have your feet on two of the three foot presence pedals to operate the truck.

Note: If you remove a foot from one of the presence pedals while standing, the brake is applied. However if you remove a foot from one of the presence pedals while seated, the truck will coast. You must use the brake pedals or plugging to stop the truck (see pages 19 & 20).

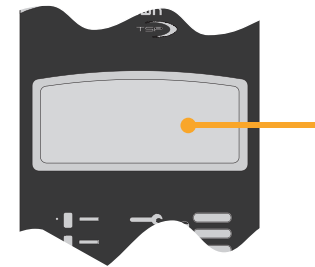

CHECK YOUR DISPLAY

If any truck function doesn't work, your hands or feet may be out of position, check the message area of the display for instructions.

! Know the Hazards

! DANGER

Falling from a raised platform can cause serious injury or even death.



Attach safety harness and lanyard when elevated and working with an open side gate or with narrow front rail option.

FALLS CAN KILL

You can reduce the risk of injury by being extra careful while working on an elevated Turret Stockpicker.

- Put the side gates down and keep your entire body inside the operator area.
- Always watch where you're going. Running into an object could cause you to fall.
- Wear your harness and keep your lanyard fastened when working with an open side gate, or if your truck has the narrow front rail option.

Traverse & Pivot



TRAVERSE ←| |→ (right multi-task handle)

Roll the thumb ball to the left to move the carriage or forks to the left. Roll the ball to the right to move the carriage or forks to the right.

The farther you move the ball from neutral, the faster the carriage or forks will move.

Before you traverse a load, make certain it will clear the platform.



PIVOT ↑| ↓ (left multi-task handle)

Push the thumb ball to the left to pivot the forks clockwise. Push the ball to the right to pivot the forks counter clockwise.

Before you pivot a load, make certain it will not poke or intrude into the operator area.



AUTO PIVOT

This feature allows you to traverse and pivot at the same time, keeping the mast and forks within the running lines of the truck.

Press the trigger on the front of the left multi-task handle. Then roll the traverse thumb ball in the direction you want the mast and forks to traverse. The forks will traverse and pivot automatically.



OPTIONAL FUNCTIONS (right multi-task handle)

This thumb ball movement is available to control optional functions such as fork tilt or fork position. Your company must train you how to operate any options.

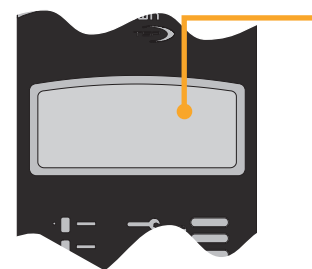

CHECK YOUR DISPLAY

If any hydraulic function doesn't work, check the message area of the display for instructions.

- The gates must be down.
- The hand sensors and foot-presence pedals must be actuated.
- Some service conditions may also prevent you from operating your truck.



MANUAL TRAVERSE

If there is a problem with traverse, you can have someone on the floor assist you by using the power unit manual traverse switch. The switch is located under the rear power unit cover, on the right side of the truck.

• To traverse out of the rack

Locate the platform manual traverse switch in the left hand storage area.

Press this switch while your assistant on the floor is pressing the power unit switch. The forks will traverse out of the rack. Either of you can stop the movement by releasing your switch.

• To traverse into the rack

Press the platform switch twice to traverse into the rack.

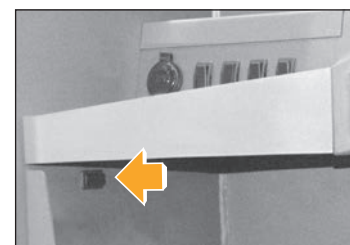

Raise & Lower

RAISE & LOWER

Primary raise and lower lets you move the entire operator platform, and forks, up or down on the primary mast.

Auxiliary raise and lower lets you move just the forks up or down on the auxiliary mast.



Primary Raise & Lower (right multi-task handle)

Move the right multi-task handle to the right to raise the platform and forks. Move the handle to the left to lower the platform and forks.

The farther you move the multi-task handle from the neutral position, the faster the platform will raise or lower.

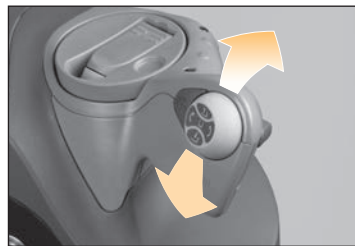
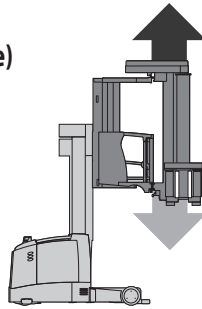

Auxiliary Raise & Lower (left multi-task handle)

Roll the thumb ball up to raise only the forks. Roll the ball down to lower only the forks.

The farther you move the ball from the neutral position, the faster the forks will raise or lower.

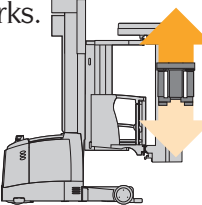

MANUAL LOWERING

If there is a problem with primary lowering, you can have someone on the floor lower the platform by using the manual lowering valve. The valve is located under the rear power unit cover, on the right side of the truck.

You must first make certain the forks are traversed clear of the rack. See page 24 for manual traverse.

Note: Always be alert to a display message or any other indications that the lift chains have become slack. A slack chain condition can cause serious injury by allowing the platform to drop suddenly. Stop lowering immediately if chains become slack.

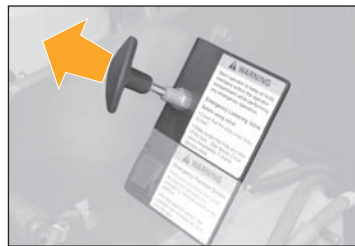

RAISE & LOWER CUTOUT (optional)

Your truck may be equipped with automatic cutout of raise or lower at selected heights.

To travel past the cutout height, push the Override button while, at the same time, moving the Raise/Lower control.

Be very careful and watch that you don't raise, lower or drive into obstructions when using the Cutout Override.

Note: The Override Button is also used with End of Aisle Control Option. See page 32.

Know the Hazards

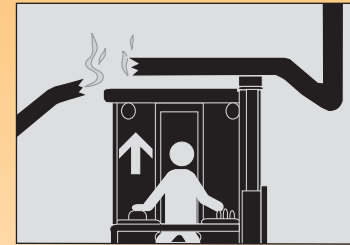

RAISE & LOWER CUTOUT OVERRIDE

Using the Cutout Override allows you to travel, or raise the platform, into areas where there are obstructions and hazards such as pipes, ducts, conduits, low ceilings etc.

Hitting any obstruction could tip the truck over, causing serious injury or even death.

Watch out for obstructions anytime you're operating your truck. Be even more careful when using Cutout Override.

MANUAL LOWERING AND TRAVERSE

Keep all body members within the operator compartment while performing any emergency operations.

SLACK CHAIN CONDITION

Always be alert for slack lift chains. This condition could allow the platform to drop suddenly and cause injury. Stop lowering immediately if chains become slack.

Steering & Travel

LIFT TRUCKS ARE NOT LIKE AUTOMOBILES

Your lift truck does not steer or drive like an automobile. Be sure you are trained to operate this truck. Even then, drive slowly until you get use to the steering and all other controls.

STEERING AND DRIVING

You will need to drive your truck both in the direction of the forks (forks first) and also away from the forks (power unit first or forks trailing). Steering is not the same in both directions.

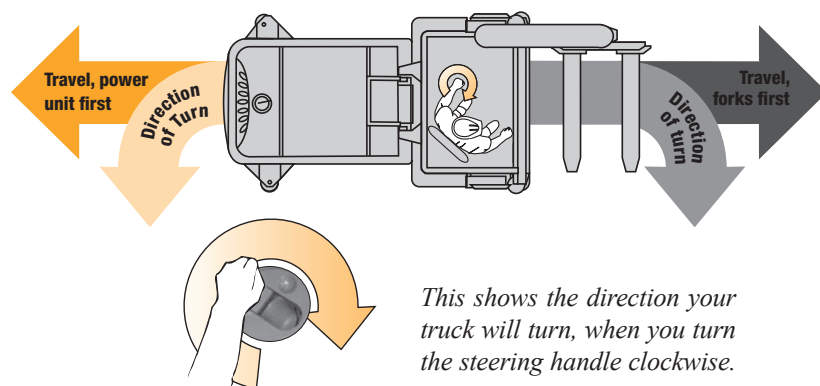

ADJUSTABLE MIRROR

Place the mirror in a position that allows you to see along the side of the truck and into the aisle behind you.

When adjusting the mirror, keep in mind all seated and standing positions you normally use.

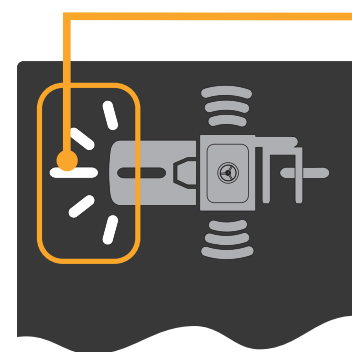

DRIVE WHEEL DIRECTION INDICATOR LIGHTS

The green light in the center shows you that the drive wheel is straight (within 1 degree).

The yellow lights to either side show the approximate position of the drive wheel while turning.

! Know the Hazards

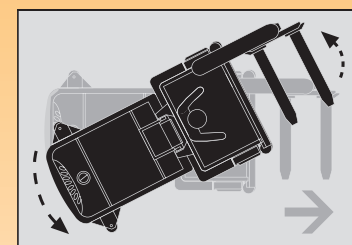

POWER UNIT SWING

Be careful turning while traveling forks first. The power unit will swing wide in the opposite direction. Make sure you have clearance, and watch out for people in the area.

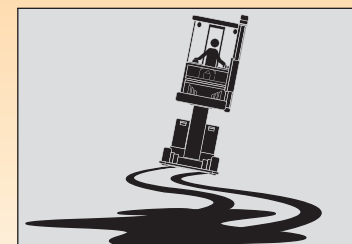

SLOW DOWN FOR SPILLS OR WET FLOORS

Powder or liquid spills can cause slippery floors. Slow down or you could lose control of steering and braking. Be careful and allow for a longer stopping distance.

Don't run over objects on the floor.

Traveling & Plugging

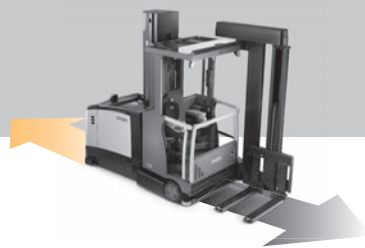

TRAVEL, FORKS FIRST

Push the right multi-task handle away from you to travel in the direction of the forks (forks first).

The farther you push the handle from the neutral position, the faster the truck will travel.



TRAVEL, POWER UNIT FIRST

Pull the right multi-task handle toward you to travel in the direction of the power unit (power unit first).

The farther you pull the handle from the neutral position, the faster the truck will travel.



PLUGGING

Plugging is another way to slow down or stop your truck.

While the truck is moving, pull or push the multi-task handle through neutral to the opposite direction of travel. Plugging will not hurt your truck.



HORN (right multi-task control)

Press the horn button to blow the horn. Use it to warn pedestrians and other drivers.

Use your horn when you leave the aisle or come to an intersection or crosswalk.

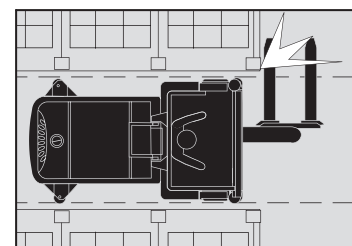

TRAVEL POSITION OF FORKS & CARRIAGE

Before traveling at full speed, you must pivot the forks and sideshift the carriage so they do not extend past the sides of the truck.

You must also make certain that the load does not extend past the sides of the truck.

CHECK YOUR DISPLAY

If your truck won't travel, or operates at a reduced speed, check the message panel on the console display.

! Know the Hazards

LOOK WHERE YOU'RE GOING

Travel in the direction where you have the best visibility.

PLUGGING VS. BRAKING

Of the two, the brakes are designed to stop the truck in the shortest distance. Use the brakes in an emergency or in busy areas.

Wire Guidance Option

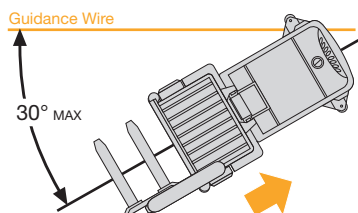

ACQUIRING THE WIRE

Toggle the wire guidance switch ON as you near a guided aisle. Approach the wire at an angle of 30° or less. Drive slowly and center the truck over the wire. When you hear a "beep" and the red light turns off, the truck takes control of steering. Start slowly.



WHEN DRIVING ON THE WIRE

- Always watch where you're going. Make sure your path is clear.
- Always be alert for "beeps" from the alarm, messages on the display, or indicator lights that signal changes in guidance status.
- Start slowly after changing direction of travel. Be sure the truck is following the wire.

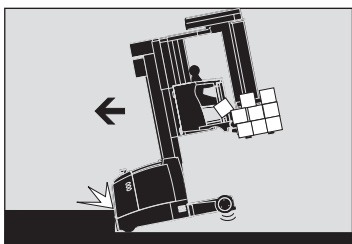

AUTOMATIC SLOW DOWN

While traveling on guidance, your truck may slow down automatically for certain conditions.

- Low signal strength from the wire.
- Truck deviates slightly from the wire.
- End of Aisle Control (optional) is activated.

AUTOMATIC STOP

Your truck may stop automatically for certain conditions.

- Signal strength from the wire is lost or is too low.
- Acquiring the wire at an angle greater than 30°.
- Truck deviates too far from the wire.
- End of Aisle Control (optional) is activated.

FOR MANUAL STEERING

Take control of the steering handle, toggle the guidance switch OFF.

Note: Whenever guidance is OFF, the red light on the display will be on, and the alarm will "beep" to remind you that you are in manual steering.

When the truck senses a guidance wire, the red light will flash and the "beeping" will speed up, to notify you that the truck senses a wire. To acquire the wire, see page 31.



END OF AISLE CONTROL OPTION

With this feature, your truck will either slow down or stop automatically when it comes to the end of an aisle. You will hear a "beep" and the indicator light will turn on.

If the truck stops: return the travel control to neutral, press the override button and resume travel.

! Know the Hazards

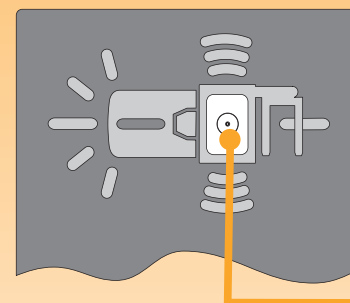

STAY ALERT

You must be just as careful and alert while driving on guidance as you are when driving with manual steering.

- Start slowly and look where you're going.
- Always be prepared to steer manually.
- Make sure there is nothing in your path, on the floor or sticking out of the racks.

LISTEN FOR THE "BEEP", CHECK THE DISPLAY

- Take control of the steering any time the red light is on.
- Check the display if you hear a "beep".

Daily Safety Check

CHECK YOUR TRUCK BEFORE STARTING WORK

You must make sure your truck is safe to use.

1. Walk around your truck and check it over..

- Inspect your harness, lanyard, snap hooks and mounting points. Have them replaced if they look damaged or worn, or have ever been used to stop a fall.
- Check to make sure the battery is charged, water level is OK and vent caps are in place. Don't use an open flame to check the battery.
- Make certain the battery retainer and side cover are properly installed.
- See that all wheels are in good condition.
- Make sure the flashing light is working.
- Check that both forks are secure and not bent, cracked or badly worn.
- Inspect all lift chains for damage.
- Look under the truck for signs of hydraulic leaks.
- Adjust the operator seat to the most comfortable position. Turn the rear view mirror to the best viewing position.
- Turn the key to TEST. See that the alarm and all indicator lights are working.
- Test the horn.
- Make sure the emergency disconnect works.

2. Test drive your truck in an uncongested area.

- Try all the hydraulic functions.
- Check that the steering is easy and smooth.
- Drive the truck slowly in both directions
- Drive through the full speed range in both forward and reverse.
- Check braking and plugging distances in forward and reverse. Load size and floor conditions can affect these distances.
- Know the distance it takes to stop before you start working. If the braking distance is too long to stop safely, don't drive the truck.
- Check wire guidance operation.

If anything doesn't look or feel right, don't drive the truck. Report the problem.

You can get checklist forms from your local Crown dealer (part no. OF3772). Used properly, this checklist can alert service people to needed repairs.

Be a Safe Driver

The most important component is you.



MAKE SURE YOU ARE READY TO DRIVE

- Do not use this truck unless you are trained and certified.
- Be certain you understand how your truck works and the hazards that go with it. Don't drive the truck if you have any doubts.
- Know the capacity of your truck (Load Weight, Load Center and Lift Height). Make certain you use the correct units of measure.
- Some trucks are not allowed in areas where there are fire hazards. Be certain your truck is the correct fire safety type for the area.
- Make sure your hands and shoes are clean and dry, and your clothing is proper for the job.

MAKE SURE YOUR TRUCK IS READY

- Inspect your truck before using it (see pages 33 and 34). If it's not working right, or something is broken, report the problem. Don't use the truck.
- In an open area, test the braking and plugging. Check at a slow travel speed first, then a faster one. Know the distance it takes to stop before you start work.

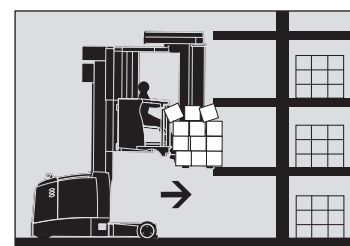
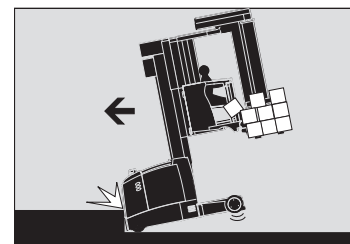

DRIVE CAUTIOUSLY, BE ALERT

- Wear your harness and have the lanyard fastened when elevated, working with an open side gate, or with the narrow front rail option.
- Never stick an arm, foot or any part of your body outside the operator area, no matter how slow the truck is moving. A hand or foot caught between the truck and a fixed object will be crushed or even cut off.
- Keep your hands on the controls and feet on the pedals.
- Travel in the direction that gives you the best view. Look where you're going, slow down in congested areas.
- Slow down for slippery floors. Don't run over things.
- Travel with the platform close to the ground when outside of an aisle. Place the load against the vertical face of the forks.
- Be certain forks and load are in the travel position.
- Look where you are going before you change direction of travel. Slow down when making turns.
- See that you have room to drive and turn. Check for overhead objects. Watch out for power unit and fork (load) swing.
- Make certain the load will clear the operator platform before you use Traverse, Extend/Retract or Pivot.
- Avoid sudden movement of controls. Learn to use them smoothly at a moderate, even rate.
- Check clearances before raising or lowering the forks or load. Watch for overhead obstructions.
- Be extra careful if you must use your truck in an area where there is a risk of falling objects.

Continued on next page...



WATCH OUT FOR OTHER PEOPLE

- Slow down. Yield or stop for pedestrians. Use your horn when you come to a crosswalk or intersection.
- Be careful that you don't pin or crush someone. *For example: Never drive your truck toward anyone standing in front of a fixed object.*
- Watch out for power unit and fork (load) swing when turning.
- Never allow passengers on your truck.
- Keep others away from your truck while you're working. Don't ever allow anyone on or under the load or forks.
- Don't let anyone use your truck unless they are trained and certified.
- Never lift anyone with the forks unless they are using an approved platform. Even then use extreme caution:
 - Use a securely attached and approved safety platform.
 - Make certain lifting mechanism is operating properly.
 - Make certain truck is in neutral and brake is applied.
 - Lift and lower slowly.
 - Watch for overhead obstructions.
 - Be sure you can see and hear the person being lifted.
 - Never transport anyone on a safety platform from one location to another.

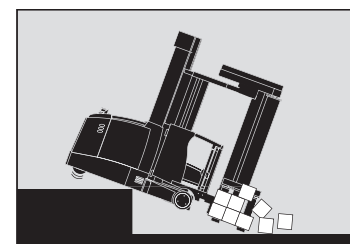
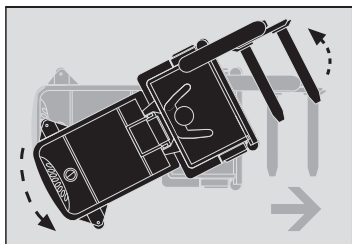

AVOID FALLS AND TIPOVERS

- Be extremely careful when working around dock or ramps. Stay away from the edge.
- Check capacities. Be sure your truck, with load, isn't too heavy for where you are driving.
- Make sure the load you are moving is stable. Spread the forks as far as you can and center the load. Insert the forks as far under the load as you can.
- Watch out for overhead obstructions.
- Turret trucks should not be used on ramps or grades. If you must drive on a grade, travel slowly and never turn the truck. If carrying a load, travel with forks upgrade. If unloaded, travel with forks downgrade. Keep the fork height below 300mm (12 inches).
- Stop your truck completely before getting off.
- Lower the forks to the floor. Turn the truck off or disconnect the battery.
- Avoid parking on inclines. But if you must, block the wheels of your truck.

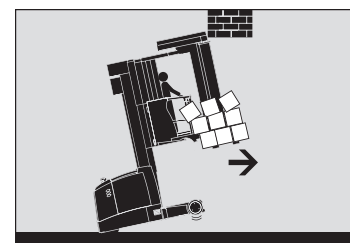

Battery Maintenance

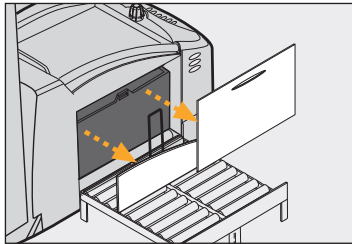

WHEN YOU INSTALL OR CHANGE THE BATTERY

- Turn the truck OFF. Make sure all controls are in neutral. Disconnect the battery.
- Make certain you use the correct size and weight battery. Never operate a truck that has an underweight or undersized battery installed.
- Use a roller stand to install or remove the battery. Make sure the roller stand is the same height as the rollers in the truck's battery compartment. Also be certain the roller stand is at least as long as your battery.
- Never let anything metal touch the top of the cells. You could cause sparks or do damage to the battery. Use an insulator (such as plywood) when necessary.
- Use an approved spreader bar to place the battery on, or remove it from a stand. Make sure you adjust the spreader bar hooks to fit the battery.

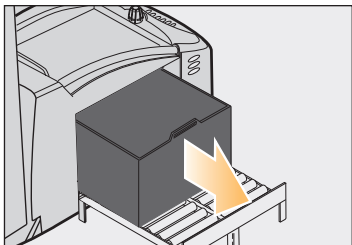

AFTER INSTALLING THE BATTERY

- Replace the battery retainer and side cover.
- Connect the battery. Turn the truck ON and check truck operation.

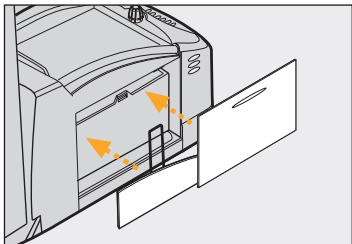

! Know the Hazards

! DANGER



Batteries produce explosive gas. Do not smoke, use open flame or create an arc or sparks near this battery. Ventilate well in enclosed areas and when charging.

Batteries contain **Sulfuric Acid** which causes severe burns. Do not get in eyes, on skin, or clothing. In case of contact, flush immediately. Get medical attention if your eyes are affected.

107

TRUCK BATTERIES CAN BE DANGEROUS

Your truck battery produces fumes that can explode. It also contains acid that could burn or disfigure you.

- Do not try to install, remove, charge or service your truck battery unless you are trained and authorized.
- Never smoke or use an open flame around batteries.
- Your company should provide an area where it is safe to work on batteries. Use that area for all battery work.
- Use protective equipment such as gloves, eye shields, aprons, etc.

BATTERY RETAINER

The battery could slide out if the retainer is not in place. Check before you operate your truck.

BATTERY SIZE

Make certain you use the correct size and weight battery. Never operate a truck that has underweight or undersized battery installed.

! WARNING

Minimum battery size allowed
000 mm (00.00 in.) wide
000 mm (00.00 in.) long

Undersize battery can affect truck handling and stability. You could have an accident.
Use U.L. classified Type EO battery.

Continued on next page...

Know the Hazards



BEFORE CHARGING YOUR TRUCK BATTERY

- Charge the battery in designated areas only.
- See that the battery cells are filled to the proper level. Never use an open flame to check the battery.
- Make certain the charger is the same voltage and amperage as your battery.
- Read the battery charger instructions.
- Be sure charger is turned off before connecting the battery to it. Otherwise you might create a spark which could cause the battery to explode. Also, make sure the truck key switch is turned off and all controls are in the neutral position.

EACH WARNING LABEL ON YOUR TRUCK IS IMPORTANT
Read and obey all of them to protect yourself and others.

A collage of various warning labels from a truck, including: 'WARNING Stay clear of moving parts', 'WARNING Never stand or ride on forks for any reason', 'WARNING It's the law, you must be trained and certified to operate this truck', 'WARNING Avoid being crushed', 'WARNING Minimum battery size allowed', 'CAUTION Undersize battery can affect truck handling and stability', 'WARNING Truck does not automatically slow down at end of aisles', 'DANGER Batteries can produce explosive gas', and 'DANGER Attach safety harness and lanyard when elevated and working with an open side gate or with narrow front gate option'.

All rights reserved under International and Pan American copyright conventions. Copyright 2008 Crown Equipment Corp.



6500 • 7000 SERIES

This operator manual has information for all models of TSP 6500 and 7000 series plus some options and accessories. Some of the illustrations and information may not apply to your truck.



The most important component is you.



New Bremen, Ohio 45869 USA

© 2011

PF18933-WEB Rev. 2/13

Printed in U.S.A.