



Forage harvesters

JAGUAR

870 860 850 840



The only choice.
The JAGUAR.





Is there an alternative to the best result? To optimal efficiency with minimal fuel consumption?

The challenges facing you are growing. Your requirements count. Ensuring your satisfaction is what drives us in our continuous pursuit of new solutions.

More productivity, more choice, more comfort, more yield: the JAGUAR 800 series offers all these qualities – and in so doing represents a class in its own right.

The only choice.
The JAGUAR models.



jaguar800.claas.com

Innovative and impressive. The advantages.

Spacious, comfortable cab with CEBIS control concept

EASY features for straight-forward data communications and a reduced operator workload

Functional design for optimal clarity and perfect airflow for the cooling system

Automatic frictional connection with front attachment via quick coupler



Silage additive dosage based on dry matter content

Efficient hydraulic system and
DYNAMIC POWER

Diesel tank capacity of up to 1300 l
for extended working

Chopping unit with direct drive and
quick-stop system

Proven crop flow with
MULTI CROP CRACKER and
accelerator gap setting

Unique accessibility concept for fast and
straight-forward maintenance

Running gear with mechanical all-wheel drive and excellent
maneuverability





CLAAS

**860
JAGUAR**

40



Contents

Cab

VISTA CAB comfort cab	10
CEBIS	12
Modular data management	14

CPS – CLAAS POWER SYSTEMS

CPS	18
Engines	20
DYNAMIC POWER	24
Running gear	26
Hydraulics and electrics	28
Drive	30

Chopping system

Crop flow	34
Intake	36
V-CLASSIC knife drum	38
Corncracker	40
Crop accelerator	42
QUANTIMETER dry matter sensor	44
Silage additive systems	46
Discharge spout	48

Front attachments

Guidance systems	52
PICK UP	54
DIRECT DISC	56
ORBIS SD, ORBIS	58
RU and CONSPEED	60

EASY – Efficient Agriculture Systems by CLAAS

EASY equipment options	62
TELEMATICS	64
PREMIUM LINE for JAGUAR	66
PREMIUM LINE for ORBIS	68
Maintenance	70
First CLAAS Service	72
Equipment package	74
Features	75
Specifications	76

Familiar but different.
The JAGUAR cab.





- Spacious cab
- Excellent visibility and lighting
- Extremely low noise level
- CEBIS information and control system
- Four seat types – for optimum comfort for everyone

Cab



The CLAAS comfort cab.

In the JAGUAR, there is simply nothing to distract you. The steering column and operator's seat can be adjusted to suit each and every operator. Thanks to the clearly laid-out displays and controls, you will feel at home in the JAGUAR in no time. Roller sunblinds, air conditioning, a radio and a coolbox also help to keep operators fresh and alert, no matter how long they are on board.

- Spacious VISTA CAB with two seats
- Glass on all sides for an all-around unrestricted view
- The windshield comes with a circular washer/wiper system
- Side and rear window wipers for a clear all-round view
- Spacious storage compartments
- Cool box with sufficient space for snacks
- Choice of four seat variants
- CEBIS control concept

Optional comfort package.

The sound insulation on the rear window effectively minimizes noise immediately around the operator's head without compromising the all-around visibility. A special windshield reduces reflections in the cab in dark or rainy conditions. Another feature which enhances the comfort package is the floor mat, which is also extremely practical: it can be cleaned quickly by knocking the dirt out of it or by using a high-pressure water jet.



- 1 Standard seat
- 2 Comfort seat
- 3 Swiveling seat
- 4 Premium seat



Ergonomic and individualized. Operating comfort and convenience.

The lighting concept.
Excellent visibility at all times.

Time is no barrier to productivity with the JAGUAR. When darkness falls, simply turn night into day. The appropriate lights can be selected quickly and easily. The service lighting allows maintenance work to be carried out after dark.



VISTA CAB
Comfort cab

Clear and convenient. CEBIS.



The CEBIS control concept.

Information, control, registration and monitoring are the tasks of the CEBIS electronic on-board information system. Distinguished by its clear, logical menu structure, it can be used intuitively.

All key machine settings are configured and displayed centrally here. You can view the harvest progress data, print it and send it via the internet.

CEBIS offers three different user options. Operation of your JAGUAR can be adjusted individually in accordance with the customer's wishes or the operator's skill level.

Fast, manageable, clear and reliable.

- The CEBIS rotary switch is used to control the basic functions
- The additional HOTKEY rotary switch allows direct on-screen control of another principal function
- All switch functions have logical, self-explanatory icons
- A Compact Flash Card makes data exchange particularly easy
- Your hand rests easily on the multifunction lever where you have instant control over the driving speed, as well as numerous other functions

CEBIS information during on-road operation





- 1 Intake on
- 2 Intake stop and reverse
- 3 Discharge spout control
- 4 Header height setting
- 5 Automatic spout swivel
- 6 AUTO FILL / spout park position
- 7 AUTO PILOT
- 8 Information button
- 9 HOTKEY direct menu rotary switch
- 10 HOTKEY direct menu rotary switch
- 11 Escape button
- 12 CEBIS direct menu rotary switch
- 13 CEBIS direct menu rotary switch
- 14 DIRECT ACCESS button
- 15 Chopping system on / off
- 16 Raise/lower discharge spout
- 17 Gear shift
- 18 Silage additive system, main switch
- 19 All-wheel drive
- 20 Diesel engine speed (three steps)
- 21 Fold front attachments



CEBIS harvest mode with night view

CEBIS



Benefit immediately from current data.

You can prepare customer data in CEBIS before running and processing it with CEBIS.

- All the data is backed up when a specific job is completed or the work day comes to an end
- The data can be printed out selectively or transferred by data card for job processing
- With TELEMATICS, the data can also be accessed online with a PC and can be reused, e.g. for customer invoicing

Data management.

1. Job management, standard

It is possible to create a collection of 20 jobs in CEBIS. As a result, all the relevant data is available to you at all times and you also have the option of printing it out.

2. Job management (initial expansion stage)

AGROCOM MAP START software allows you to manage data relating to specific customers and jobs and then transfer this to your PC by means of a Compact Flash Card. Furthermore, TELEMATICS allows you to monitor the job in question online.

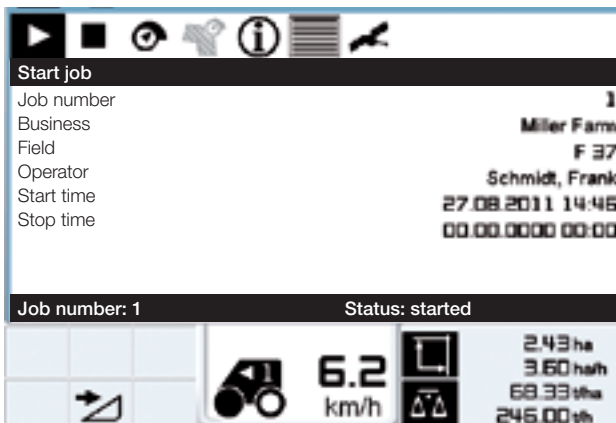

Individual data can be printed selectively



Modular and ready for immediate use. Data management.



3. Job management (second expansion stage): yield mapping

Building on the foundation of the job management function, you can use your JAGUAR to perform yield mapping. The QUANTIMETER and the moisture measurement allow you to determine the yield. At the same time, CEBIS adds geographical coordinates obtained from GPS satellites. All the measured data is stored on a portable chip card to facilitate transfer. The AGROCOM MAP START software is included to enable you to produce informative yield maps to use as a basis for your future production strategy.

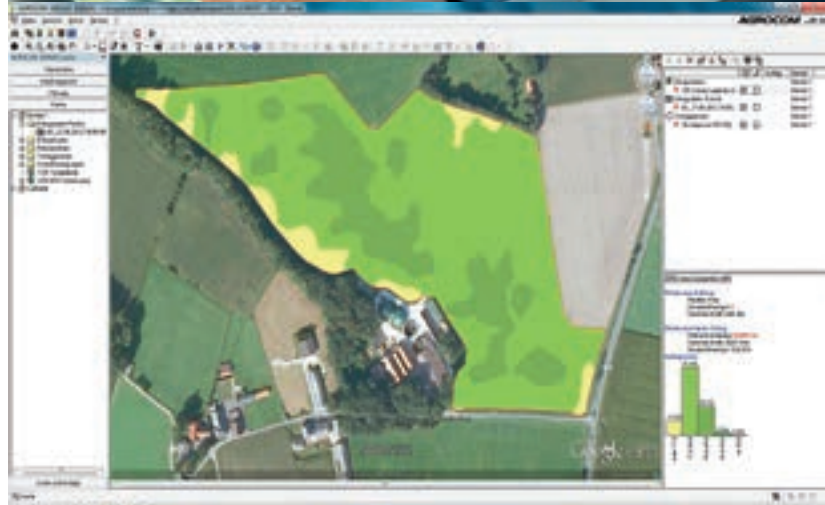

Modular data management

Top performance and
cost-effectiveness.
JAGUAR technology.





- Higher performance with outstanding engines
- Cooling system designed for top performance
- DYNAMIC POWER: diesel savings in the partial-load range
- Reliable running gear
- Straight-forward, highly efficient drive system

CPS –
CLAAS POWER SYSTEMS

Unique and outstanding. CPS – CLAAS POWER SYSTEMS.

Optimal drive for best results.

Equipment development at CLAAS means an ongoing effort for even greater efficiency and reliability as well as optimal profitability in the field.

Of course, this applies to all aspects of a CLAAS forage harvester. A case in point is the drive system which is of decisive importance for the performance of the entire machine and which calls for a lot more than just a powerful engine.

In CLAAS POWER SYSTEMS (CPS), we have brought together top-quality components to create a drive system that is in a class of its own – one that always delivers the most efficient power when needed. CPS is ideally matched to the work systems, featuring fuel-saving technology that quickly pays for itself.

The intelligent DYNAMIC POWER engine control system from CLAAS provides the best possible implementation of the CPS philosophy: optimal, automatic provision of the appropriate power for the JAGUAR in line with requirements. It is another example of our approach to achieving real fuel savings. The decisive factor is not the engine itself but the ability to control the available output intelligently – so you can do more with less.



CPS | CLAAS
POWER
SYSTEMS

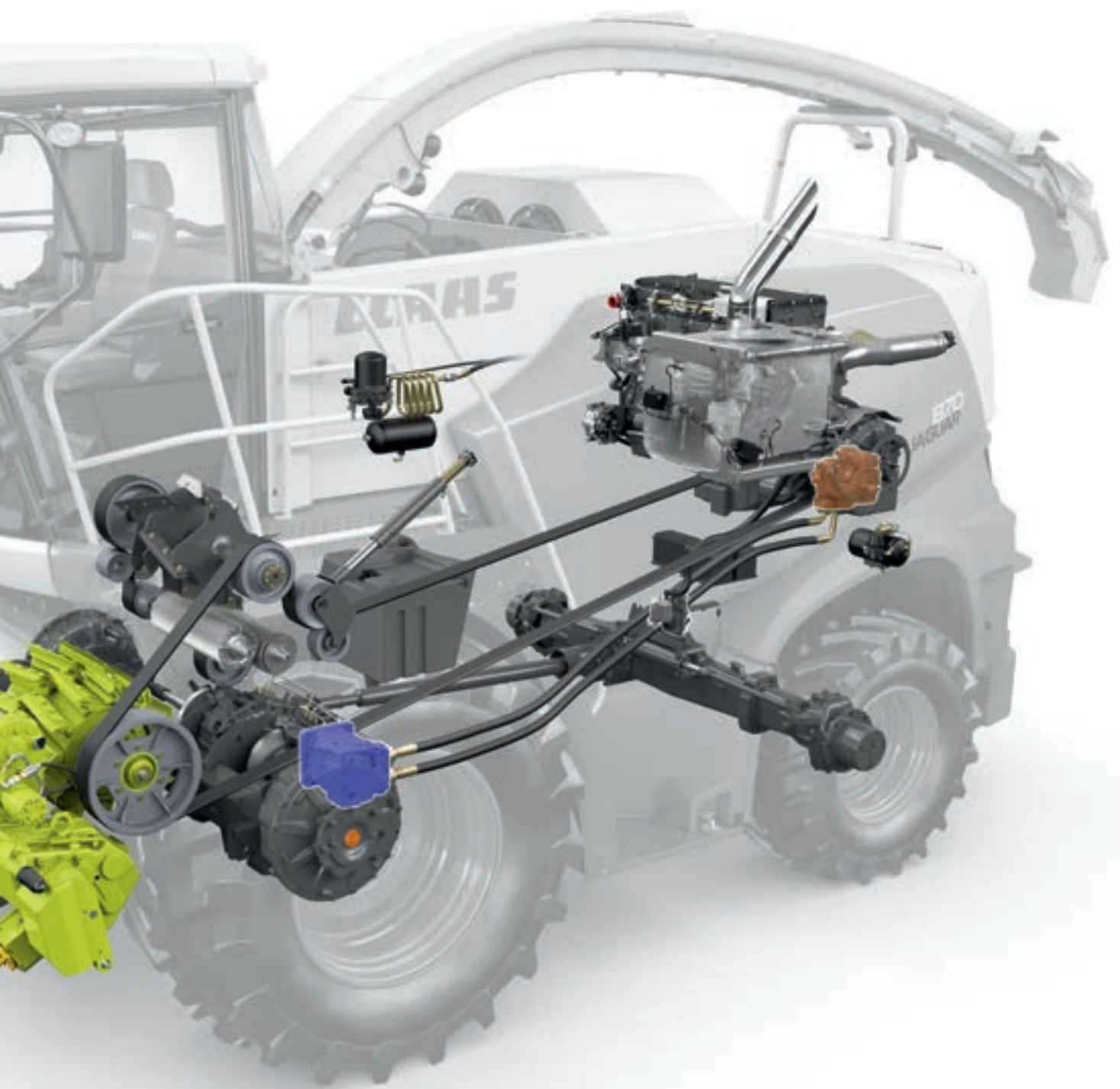

Powerful and environmentally compatible. Mercedes-Benz engine technology.

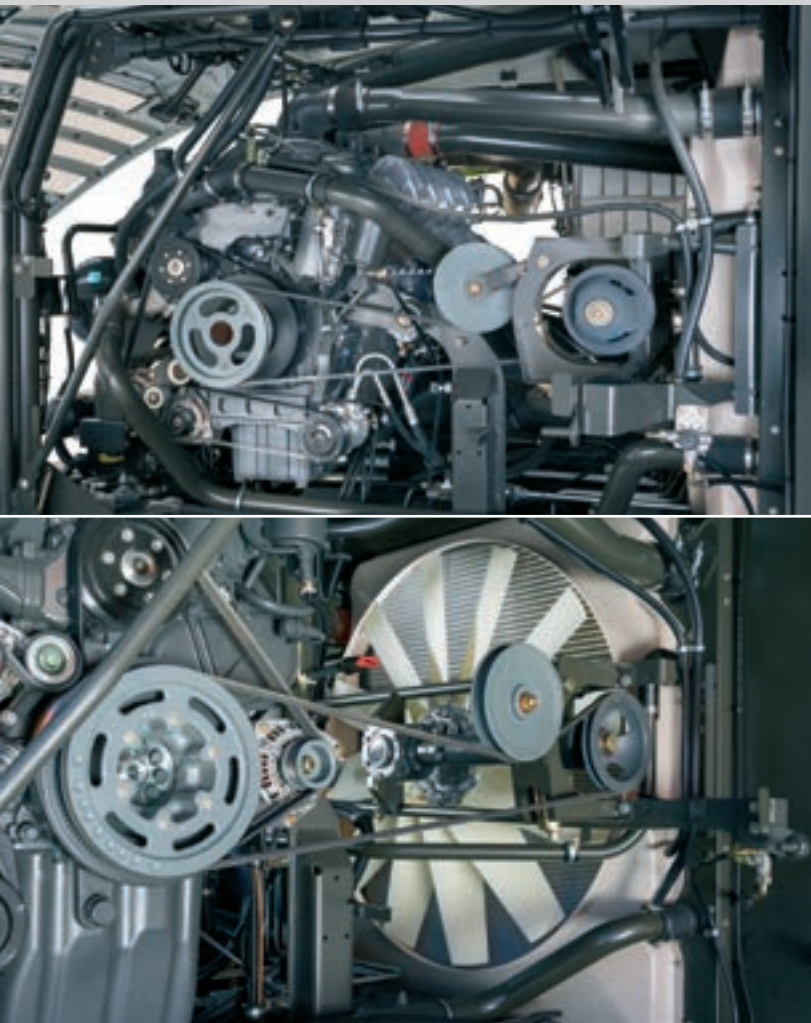

Powerful Mercedes-Benz engines.

CLAAS POWER SYSTEMS encompasses the full range of drive technology and matches it with the appropriate engine to form an optimally tuned and integrated drive system. This results in the highest level of efficiency available in the market.

It goes without saying that CLAAS products meet the different emissions standards which apply around the world. In markets where Stage IIIB (Tier 4i) applies, an exhaust-gas aftertreatment system downstream from the engine is used to ensure compliance. This system uses Selective Catalytic Reduction (SCR) to convert the nitrogen oxides in the exhaust flow into nitrogen and water. The urea solution necessary for this is carried in a 130-liter tank. Urea consumption is about 5% of the diesel consumption.

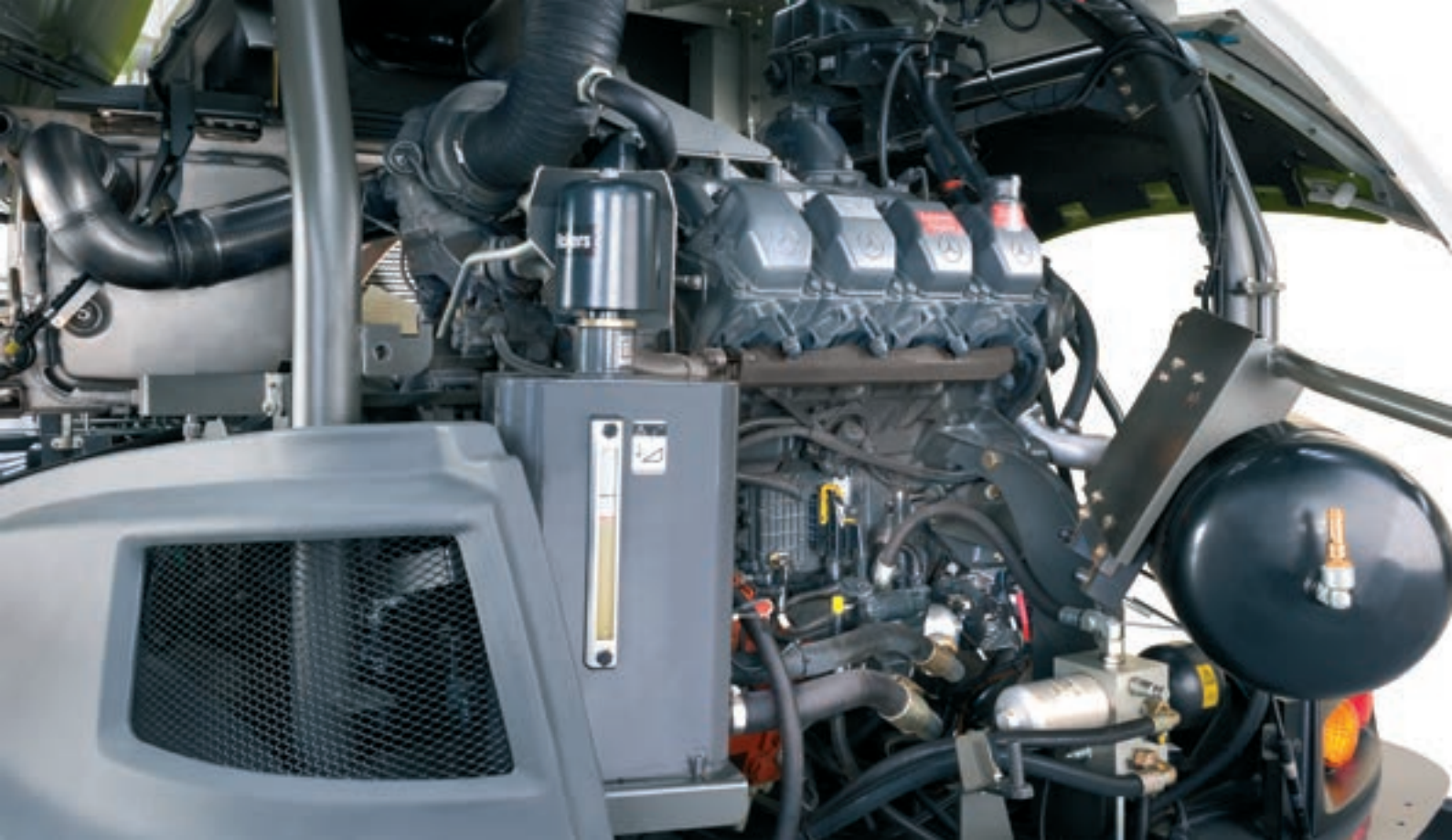

The engine is rubber mounted to the chassis to minimize noise and vibration. This means you get the best of both worlds: immense power reserves plus top driver comfort.

- Fuel-efficient performance with low noise
- Compliance with the statutory emissions limits
- Steady power rise up to the ideal engine speed of 1800 rpm

JAGUAR 870 Stage IIIB (Tier 4i)

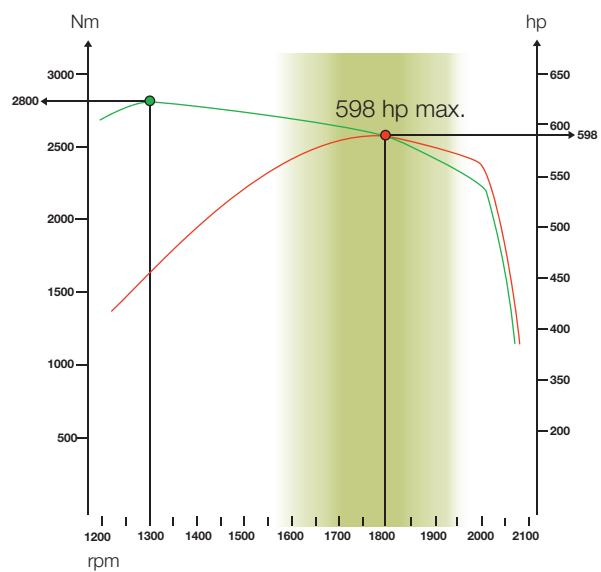

JAGUAR engines		870	860	850	840
Stage IIIB (Tier 4i)	Type	OM 502	OM 502	OM 460	OM 460
	kW/hp	440/598	375/510	335/455	294/400



Reliable cooling.

Record-breaking performance is no excuse for breaking out in a sweat. In the JAGUAR, horizontal slab radiators provide effective cooling under all harvesting conditions. The large surface area of the radiator screen keeps air speeds down, thereby reducing dirt build-up. The screen itself is kept clean by a rotating extractor arm.

The airflow from the fan is directed past the engine and can escape practically unhindered through the large air outlet at the rear. As a result, the JAGUAR can be counted on to continue operating reliably even in extremely hot weather.



Effective and reliable. The cooling system.

Breathing easy.

Large air filters ensure long and reliable operation. Pre-treated engine air is drawn in directly from the radiator compartment. When necessary, the filters can be removed without the need for tools and can be cleaned straight away in the field. The integrated compressor delivers 600 l of air per minute at 9.5 bar. This is sufficient to also allow air-driven tools to be operated and to supply the optional trailer braking system which is available for the JAGUAR.

Large tank for extended working.

The extremely well thought-out tank concept lends itself to extended working. In forage harvesters with exhaust gas after-treatment, the urea solution only needs to be replenished during every other refuelling stop.



JAGUAR

emissions standard	Diesel tank	Auxiliary diesel tank (option)	Total diesel capacity	Urea tank
Stage IIIB (Tier 4i)	1000 l	300 l	1300 l	130 l



Engines

Intelligent and efficient. DYNAMIC POWER.



Only as much power as is needed.

The JAGUAR 870 and JAGUAR 860 models can be equipped with the DYNAMIC POWER automatic engine output control system.

Maximum efficiency and throughput are attained when operating at full load. In the partial load range, the engine output is reduced automatically. This makes it possible to achieve fuel savings of up to 10.6%.

DYNAMIC POWER adjusts the engine output optimally to the field conditions in ten steps. This ensures that you are always operating in the most efficient engine speed range.

Smooth sailing with cruise control.

The combination of DYNAMIC POWER and cruise control not only saves fuel but also reduces the strain on the operator to a significant degree. Once an optimum speed has been agreed, the entire harvesting chain can operate extremely efficiently and consistently. JAGUAR forage harvesters with high-capacity engines can therefore also be operated very cost-effectively in smaller-scale settings or under conditions which restrict the ground speed.

- Save diesel during partial-load operation
- Economical, consistent working with cruise control

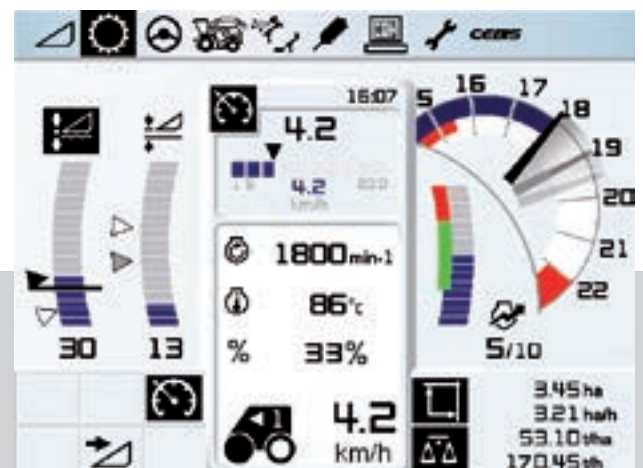



Engine output in hp.

JAGUAR 870 Stage IIIB (Tier 4i)

	JAGUAR 870 Stage IIIB (Tier 4i)	JAGUAR 860 Stage IIIB (Tier 4i)
Step		
10	598	510
9	566	487
8	533	463
7	500	439
6	468	415
5	435	392
4	402	368
3	370	344
2	337	320
1	305	296
min	272	272

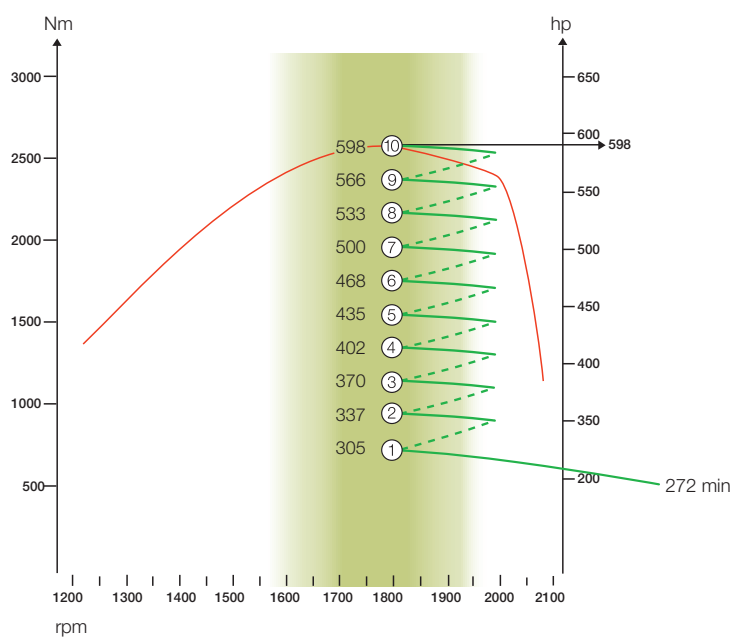

DYNAMIC POWER



Huge reserves.

With its impressive tractive power, the ground drive is designed to get you through. You can call on huge power reserves, even under the most difficult conditions. A harvesting speed of up to 16.8 km/h is possible in first gear. The small turning radius and increased ground clearance of the JAGUAR 800 series make it extremely maneuverable.

Economical on the road.

When running at top speed on the road, the JAGUAR operates with a drastically reduced engine speed. The electronic ground drive control automatically regulates the engine speed and matches it exactly to the required output. This cuts fuel consumption noticeably and minimizes noise levels.

Active header damping.

This active vibration damping function guarantees that you travel not just quickly, but also with considerably improved comfort. Simply activate the function when on the road, and the hydraulics effectively dampen the movements of the front attachment, making your progress from one job to the next much smoother. Vibration damping is activated automatically when, for example, the front attachment is raised (above working height) when turning at the headland.



High pulling power and reliability. The running gear.

Mechanical all-wheel drive.

Under difficult working conditions, the electrohydraulically activated four-wheel drive provides maximum traction. The power is transferred directly to the rear axle via a drive shaft.

Rear camera: improved view when reversing.

If the JAGUAR is equipped with an optional rear camera, the view from it is shown automatically on the CEBIS monitor when reverse is selected with the control lever. This allows trailers to be coupled safely and improves the operator's view of the surroundings.

- Optimal pulling power
- Very good turning radius for high maneuverability
- Fast, economical on-road operation
- Vibration damping on the road
- Rear camera



Running gear

Clear and straightforward. Hydraulic and electrical systems.

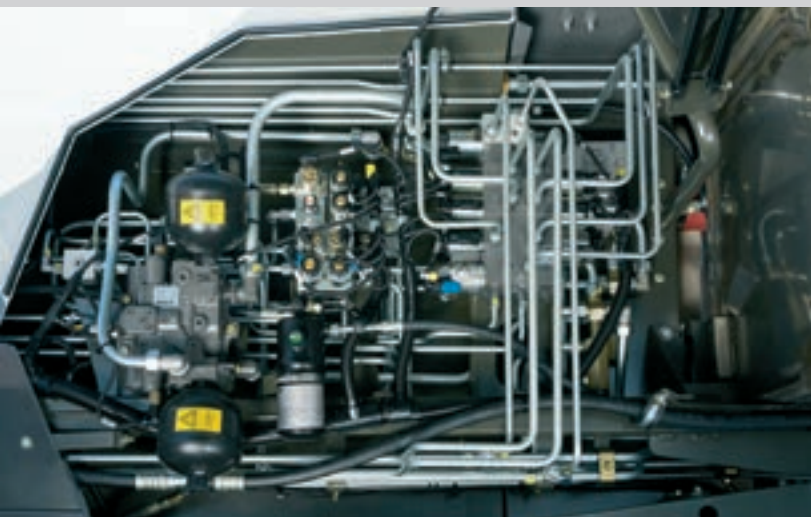

The hydraulics.

The hydraulic valves are clearly laid out on the left side of the machine. Proportional valves for the discharge spout and front attachment control system make for a smoother response when these systems are functioning automatically. In order to leave a consistent stubble profile, even when operating at very high ground speeds, the swivel speed of the ORBIS lateral leveling mechanism, for example, can be adjusted as required in CEBIS.

The vibration damping system is activated automatically once the headland is reached and the front attachment raised past the working height. This additional convenience feature reduces wear and tear on the machine when crossing sprayer wheelings, for example. The front attachment is protected by a correspondingly gentle suspension response.

- Clearly laid-out hydraulic system
- Rapid implementation of function commands
- Efficient control by proportional valves
- Cost-effective maintenance thanks to low-volume oil system



Clean, fast connection
of machine functions



The electrical system.

A straight-forward, convenient control concept demands a fast, reliable electrical system. In the JAGUAR, all the key components are housed securely and centrally in the cab. An expansion box (Option Ready) in the maintenance compartment of the JAGUAR allows additional options to be easily accommodated – for instance if retrofitting:

- PROFI CAM
- AUTO FILL
- ACTISILER 20
- NIR Sensor
- 300 l auxiliary diesel tank

Customer benefits:

- Electrics housed securely in cab
- CAN-bus system with diagnostic function
- Reliable, high-quality cable connections
- High-quality expansion box for adaptation of additional variants





Trend-setting advantages:
setting the pace for two decades.

The revolutionary drive concept of the JAGUAR was developed by CLAAS engineers in 1993 and still sets the standard today. The direct power transmission has proven itself thousands of times over in practical use. For this generation of the JAGUAR we have again stayed true to our tradition with a transverse engine arrangement.

- The chopping mechanism is driven directly from the engine main clutch via a pre-tensioned powerband – entirely maintenance-free
- The disc brake attached to the main clutch ensures that the chopping mechanism stops rapidly when the main drive is switched off – thereby enhancing safety
- The direct drive guarantees highly efficient power transmission while also keeping the specific power requirement low – high efficiency
- The front attachment is driven mechanically, the connection is provided by a quick coupling – extremely convenient



Unmatched and unchanged.
The drive.



Proven JAGUAR technology,
enhanced yet again.
The chopping system.





- Proven, straight-line crop flow
- Operational reliability in all crops and under all operating conditions
- Excellent chopping quality

Chopping system

Straight and fast. The crop flow.



Maximum throughput with low power consumption.

An optimal crop flow is a major factor in determining the daily output. The crop flows in a straight line through the entire machine without any awkward angles. It makes no difference whether you are harvesting grass without the Corncracker or are working in silage corn with the Corncracker. The crop is accelerated further at each step and is centered increasingly by the chevron arrangement of the knives and accelerator paddles. This results in maximum performance with minimum power consumption and ensures highly reliable operation. The JAGUAR demonstrates this time after time: with outstanding results – measured in terms of fuel consumption in liters per ton.



1 Intake

- Robust with perfect precompression

2 V-CLASSIC knife drum

- Precise cutting for excellent chop quality
- Central delivery of chopped material for low wear

3 Corncracker

- Optimal crop processing

4 Accelerator

- Central delivery of chopped material for reliable crop transport
- Mechanically adjustable clearance



Robust rollers.

The intake roller drive in the JAGUAR is designed for extremely high performance. Six cutting lengths can be set as required. Robust compression rollers ensure an optimum crop flow. Additional wear bars reduce wear to the machine.

Hydraulic reverser.

The hydraulic reverser ensures a slow, controlled and sensitive reverse rotation. The crop is gently extracted from the intake. When used with the PICK UP, the roller crop press is raised automatically, and, if required, the auger as well. With incremental reversing, foreign objects are brought to the intake rollers, where they can be removed quickly and safely.



Powerful and reliable. The intake.



Sensitive metal detector.

The metal detection system installed in the front feed rollers locates any magnetic object in good time. The low-wear, quick-stop mechanism then stops the intake immediately. Thanks to the location display in CEBIS, the operator can quickly see where the magnetic metal object is to be found.

STOP ROCK stone detector.

A powerful and rugged intake drive is one thing, but full protection against foreign objects is another. The STOP ROCK stone detector increases the reliability of the JAGUAR. If it detects a stone in the swath, it stops the intake immediately. You can set the minimum stone size yourself – the sensitivity is conveniently adjustable from the cab using CEBIS.



Exclusive: the STOP ROCK stone detector immediately stops the intake.



Intake

Precise and power-saving.
V-CLASSIC
knife drum.



Chevron-shaped knife layout.

The effectiveness of the 750 mm wide chopping drum in the JAGUAR is unique. The chevron-shaped knife arrangement produces a pull-through, guillotine cut with a minimum of effort. At the same time, the forage is guided towards the middle – this reduces wear and friction losses on the sides of the drum housing.

- Robust design
- Minimum power requirement
- High throughput
- Top chop quality
- Excellent discharge

The V-CLASSIC knife drum is available in three versions:

- 1 V20 for use in coarse forage or for use primarily in grass
- 2 V24 for use in grass and corn; suitable for longer chop lengths in grass
- 3 V28 for use in grass and corn; suitable for short chop lengths in corn

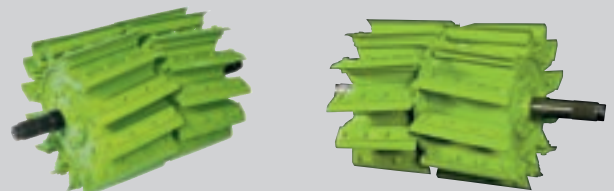



Adjustable drum concave plate.

The smooth floor in the chopping housing is standard on the JAGUAR. In order to achieve a consistent crop flow even when the knives have not been reset, it is possible to make a quick adjustment using spacer discs. This ensures the smallest-possible clearance to the knife drum.

Thanks to the excellent accessibility, you can quickly refit the JAGUAR:

- With a four-slat insert for late corn harvesting
- With a friction concave plate for WCS/earlage harvests

Fully automatic sharpening.

A precision chop and consistent chop quality are possible only if the blades are absolutely sharp. The sharpening of the knives is controlled from the cab.

As an option, you can also control the shear-bar setting from the cab. The shear bar doesn't need to be loosened for this operation; instead, the mounting block is pivoted and moves gently towards the knife drum with the shear bar firmly fixed on top. Knock sensors register contact and set the shear bar accordingly.

Sharpening and adjustment of the shear bar should be carried out on the basis of the throughput quantity rather than at a given time of day. CEBIS can be configured to give a reminder when knife sharpening is required.

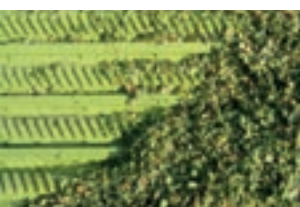

Friction concave for whole crop silage or earlage



Mechanical shear bar adjustment



V-CLASSIC knife drum



MULTI CROP CRACKER M.

Demands on flexibility are growing. In addition to the proven INTENSIVE CRACKER (M = roller diameter of 196 mm), CLAAS offers the flexible MULTI CROP CRACKER M (MCC M). The MCC M can be adjusted quickly and easily to different harvesting conditions simply by changing the rollers. The extremely rugged design ensures high-performance crop processing, even at very high throughput rates. As an option, the JAGUAR 870 can also be equipped with the MCC L (L = roller diameter of 250 mm).

All CLAAS Corncracker units can be quickly fitted in place of the grass chute. During the interim period between grass and corn harvesting, the Corncracker can be stored in the machine. Roller gap adjustment is performed manually on the Cracker or, as an option, electrohydraulically from the cab. Hard-chrome-plated rollers make for a long service life.



Precise chopping quality: corn



Whole crop silage (WCS)



Tough and relentless. The Corncracker.

The MULTI CROP CRACKER M has the following key characteristics:

- Extremely rugged design, large bearing units and sealed housing design
- High degree of flexibility through fast replacement of cracker rollers
- Can be adjusted to an extremely diverse range of applications (corn, sorghum, grain)
- Very high throughput with optimum chop processing
- Mechanical belt tensioning for maximum power transmission
- The various components can all be accessed extremely easily



Corncracker

Extremely dynamic and designed for quick maintenance. The crop accelerator.



Acceleration the energy-saving way.

The accelerator is ideally positioned in the JAGUAR for optimum performance of its task of speeding up the crop flow and feeding the crop reliably. The chevron-shaped accelerator paddles center the crop flow, thereby reducing the wear on the side walls of the discharge chute. As the crop flow does not have to negotiate any awkward angles, correspondingly little energy is required to move it.

For heavy crops, the clearance between the accelerator and the rear wall can be increased by up to 10 mm. This results in a huge reduction in the amount of energy required. If, for example, very dry grass requires a high discharge rate, a very narrow clearance setting is required. The setting can easily be adjusted mechanically in the maintenance compartment.



Extremely fast removal.

CLAAS offers an easy solution for removing the accelerator when post-harvest cleaning is required or if it should prove necessary to replace wear parts. Two people can carry out the removal procedure in one hour. This is a unique advantage in the entire forage harvester sector.



Crop accelerator

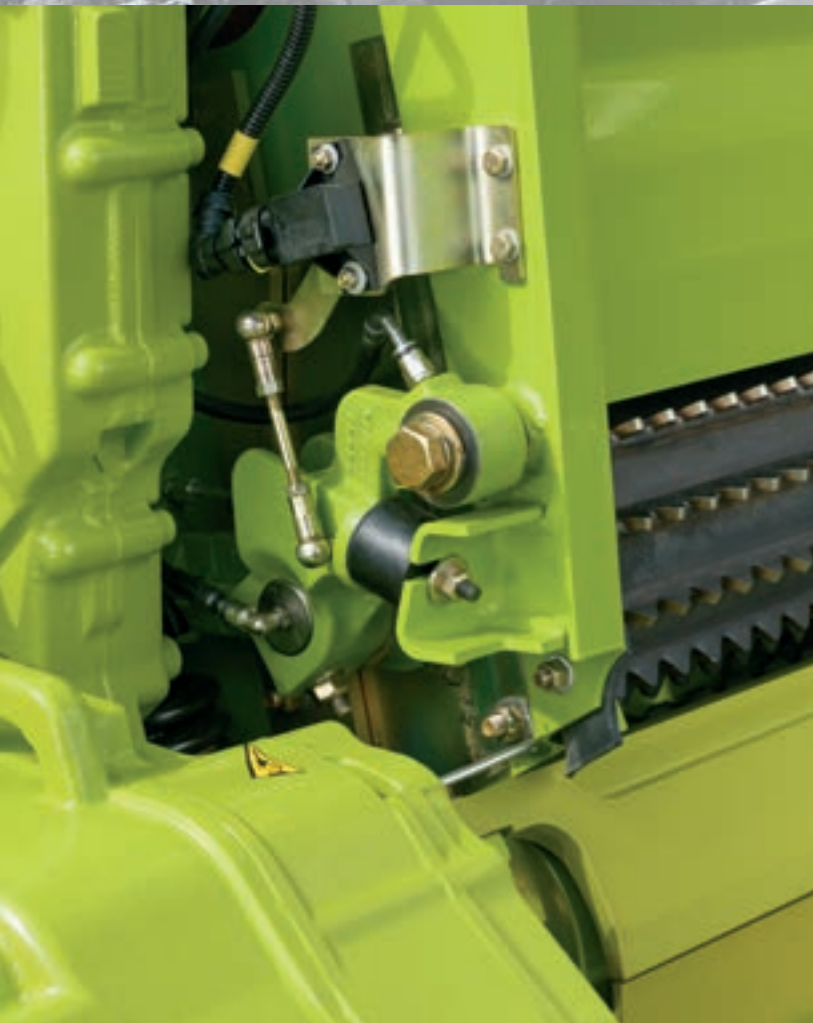

Throughput measurement with the QUANTIMETER.

By recording the deflection of the upper rear precompression roller, together with the intake width and intake speed parameters, the volume flow is measured continuously. Counterweighing is recommended in order to ensure the highest possible degree of accuracy (tonnes per hectare). Retrospective adjustment of the yield data obtained at the start of the job is possible. Retrospective calibration using a new calibration value allows counterweighing to be delayed until any point between the start and finish of the harvesting process.

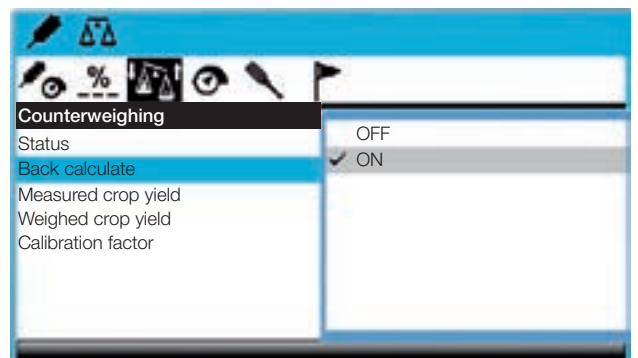

Continuous and precise. Throughput measurement.



Dry matter measurement.

Continuous dry matter measurement significantly improves the accuracy of the current throughput measurement.

- The moisture of the crop is measured in the spout
- CEBIS continuously displays the current dry matter content
- Highly wear-resistant ceramic base plate with metal rings for a long service life

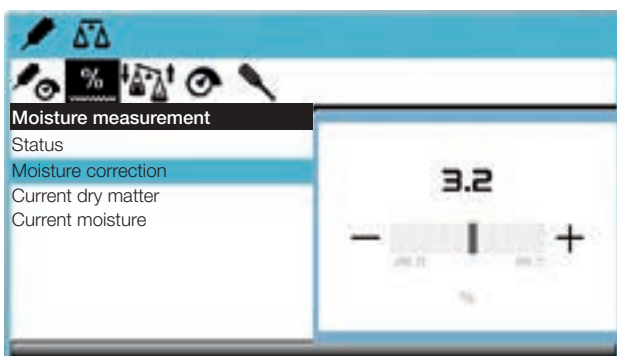

QUANTIMETER
Dry matter sensor

Concentrated and precise. Silage additive system.



- Tank capacity of 375 l
- Flexible filling and cleaning facility
- Metering from 30 l/h to 400 l/h
- Throughput based metering from 0.5 l/t to 2 l/t (up to 200 t/h)
- Dosage on basis of dry matter possible
- Sight tube for external level indication
- The dosage is controlled via CEBIS which also informs the operator about the fill level of the tanks.

Using additives to enhance silage quality.

Applying silage additives while chopping has become a standard service offered by professional contractors. You can carry up to 375 l of fluid in the standard-fit additive tank which is easy to fill. The mixed additive is sprayed straight into the crop accelerator.



Large opening for cleaning

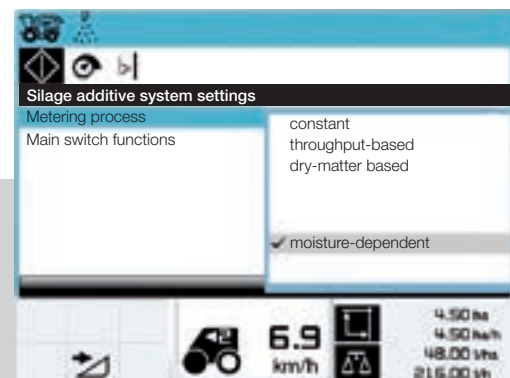



ACTISILER 20 for precise dosage.

There is currently a trend towards a reduced quantity and a higher concentration. The new, optional ACTISILER 20 has been designed specifically to achieve this high-precision task with a precisely metered quantity of concentrated lactic acid bacteria solution. The control of the dosage, the record of how much you apply and the monitoring functions are all easily managed using CEBIS.

- Separate 20 l tank for highly concentrated lactic acid solution
- Dosage is controlled via CEBIS:
 - constant: 200 ml/h to 7500 ml/h;
 - throughput-based: 10 ml/t to 30 ml/t;
- Dosage on basis of dry matter possible

Both systems can also be used simultaneously.



Set dosage parameters			
Parameter	Loc	Ref.	and
Water tank dosage	500 ml/t	1000 ml/t	2000 ml/t
Concentrate dosage	30 ml/t	15 ml/t	0 ml/t
Moisture	69 %	64 %	51 %

6.9 km/h	4.50 ha
	4.50 ha/h
	48.00 t/ha
	216.00 t/h

Silage additive systems

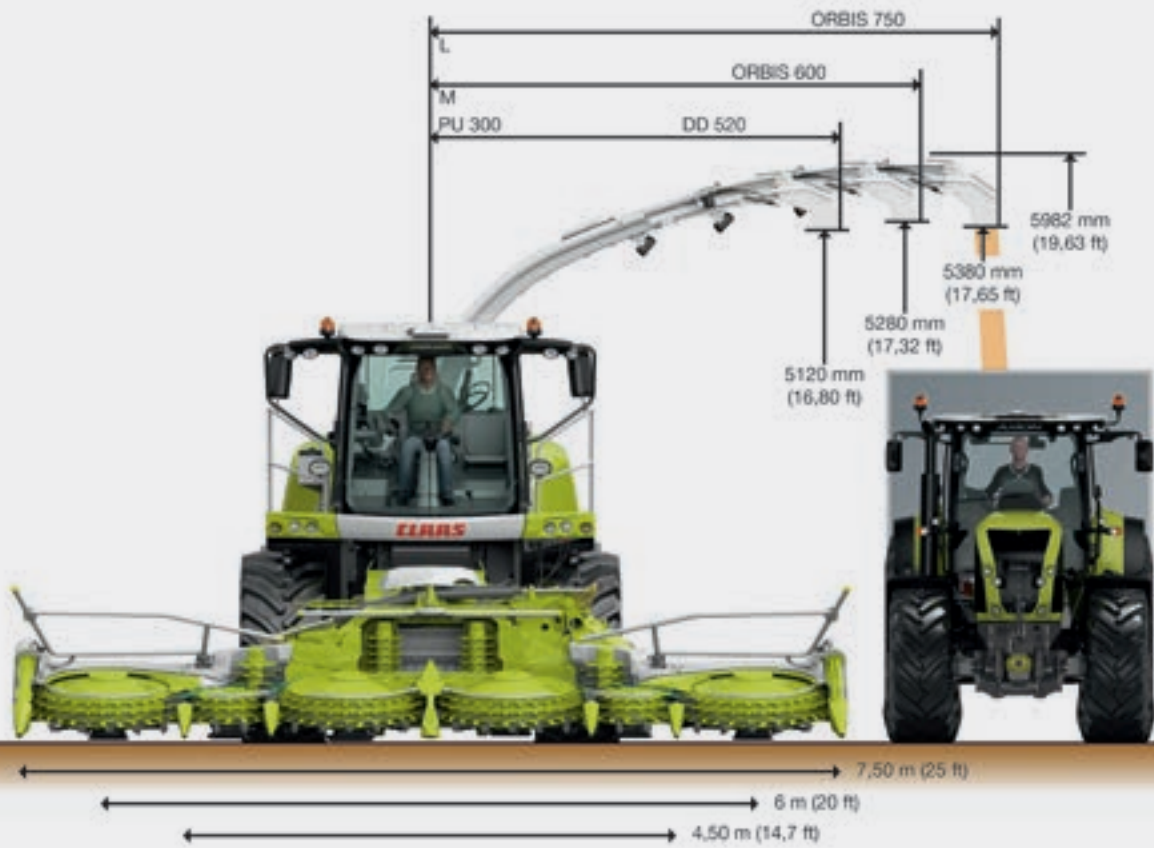

The discharge spout. Modular design.

High strength and a low dead weight are the key characteristics of the discharge spout. The concentrated crop stream can be directed more reliably, minimizing wasteful losses. The modular design enables the system to be rapidly adjusted to different working widths. Two extensions (M / L) allow operation up to a working width of 7.5 meters. The back of the discharge spout is entirely bolted: as a result, the top plates also function as wear plates.

OPTI FILL. Extremely user-friendly.

The OPTI FILL optimized spout control system makes management of the transfer process extremely easy. The wide swivel angle of up to 225° allows an optimal view of the transfer process. When the discharge spout is swiveled, the end flap is adjusted automatically so that the transfer process takes place parallel to the direction of travel. Two permanently programmed spout positions simplify the swiveling process at the end of the field, e.g. when chopping up and down along one edge of a field. Furthermore, the discharge spout can be returned to its parking position automatically at the touch of a button.



Additional equipment, such as PROFI CAM can be retrofitted easily.



Concentrated
and accurate.
The discharge.

AUTO FILL. Automatic filling of trailers.

AUTO FILL is based on the principle of digital 3D image analysis. By analyzing the camera images of the trailer traveling alongside, the system is capable of determining both the outer edges and the fill level at any position in the trailer. Additionally, the system is able to determine where the harvested crop will impact as it enters the trailer. The data obtained is used to control the discharge spout automatically lengthwise and crosswise in relation to the vehicle axis. This process results in optimal filling of the trailer.



Discharge spout

Effective and durable.
The JAGUAR front attachments.





PICK UP



DIRECT DISC



RU



ORBIS



CONSPEED

- Corn harvesting with ORBIS or RU
- Windrow clearance with PICK UP
- Whole-plant cutting with DIRECT DISC
- Corn picking with CONSPEED

Front attachments

Precision system that reduces operator's workload. The guidance systems.

Seeing with CAM PILOT.

The CAM PILOT assumes control of steering the JAGUAR in combination with the PICK UP. The swath is detected as a three-dimensional image by a twin-lens camera. Correction signals are transmitted to the steering mechanism in the event of deviations in the swath shape or direction. The steering axle then responds to these steering commands. This makes for a reduced operator workload at speeds up to 15 km/h as well as loss-free harvesting.



CEBIS: selection of steering system



Guidance by GPS PILOT.

GPS PILOT is operated easily by means of the S10 or S7 touchscreen terminals. This ensures reliable running in parallel lines or along curved contours at the crop edge. This reduces the stress on the driver significantly and enables the working width to be used effectively.

Sensing with AUTO PILOT.

During the harvesting process, corn is usually followed in rows, even with row-independent corn front attachments. Two sensor arms each gauge two rows of corn. The signals generated by these sensors are translated into correction steering impulses. Twin-row sensing allows automatic steering in row widths of 37.5 cm up to 80 cm.

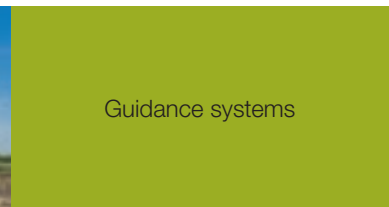

Guidance systems



Sharp performers. PICK UP 300 and 380.

The trend towards ever more powerful forage harvesters and higher yields means that requirements such as clean crop intake, robust technology and straightforward operation are becoming ever more important. The PICK UP 300 and 380 with respective working widths of 3.00 m and 3.80 m meet these requirements with a host of impressive details:

- Small-diameter rake with four or five rows of tines for clean crop intake
- Large auger diameter designed to transfer the crop quickly, even at high throughput
- Rugged drive line with easy-to-operate, two-speed gearbox
- Wear parts can be replaced easily after being subjected to extreme wear
- Excellent ground-contour following is achieved with a swiveling frame and caster guide wheels (can be set without tools)
- Attachments can be easily attached to and removed from the JAGUAR by a quick-connect coupler and central locking lever on the left-hand side



Support wheel for optimal ground-contour following



Easy replacement of wear parts

Effective and reliable. The crop intake.



Additional protection. STOP ROCK.

The STOP ROCK detector stops the intake of the JAGUAR immediately if it detects a foreign body of a size greater than that preset by the operator. The relevant settings are made in CEBIS.



Good accessibility for
searching for foreign bodies

PICK UP

Mowing and chopping. Direct harvesting. The DIRECT DISC.



Whole-crop cutting with DIRECT DISC 520.

Whether you're intending to use milk ripe plants for high-grade animal feed or as biomass for energy production, this front attachment means you can mow and chop in a single pass.

The crop is first cut by the disc mower, after which it is fed directly to the intake auger via a paddle roller. From there, the auger transfers it to the forage harvester intake.



Safe on the road



Quick blade change



Simple, convenient, proven.

- Simple attachment and locking; friction-type connection of the drive train via quick-connect coupler
- Delayed activation of paddle, auger and the mower unit means that DIRECT DISC can also be started under full load
- Three speeds of paddle and auger for a smooth crop flow and optimal chopping quality
- Proven DISCO mowing bar for high chopping output and neat work quality with AUTO CONTOUR
- Reduced downtime, thanks to quick blade change
- Perfect adaptation to harvesting conditions with hydraulically height-adjustable paddle roller
- Easy access to conveying elements through large service opening



Quick coupling

DIRECT DISC



ORBIS. Row-independent harvesting.

The ORBIS row-independent corn header combines experience gained in practical use all over the world with innovative ideas relating to the design and drive.

- Quick coupler for easy frictional connection with JAGUAR
- Working width of 4.50 m, 6.00 m or 7.50 m
- Optimal crop flow: consistent chopping quality depends on a longitudinal plant feed
- Light-running drive: low starting torque and low power requirement, so that it can be engaged and reversed under power
- 3-speed transmission for perfect adjustment to different field conditions
- Excellent ground-contour tracking with suspended-frame geometry for ideal lateral balance
- Active AUTO CONTOUR control is available as an option
- Low maintenance outlay



Gentle crop transport and self-sharpening effect



Modular structure

Incisive and flexible. The ORBIS.

New: The ORBIS 600 SD is offered in parallel to the ORBIS 600. The SD is particularly suited to normal and low-growing stands. The outer sections with the small discs and the additional vertical feed drums enable an extremely good crop flow. It is also possible to cut the stubble extremely close.

The ORBIS 600 with the large discs comes into its own in normal and very high yield corn stands.

New: Integrated transport system. During road travel, the running gear integrated in ORBIS is deployed. The hydraulic rams are actuated actively during road travel. The vibration damping allows comfortable and safe road travel at up to 40 km/h.

During field work, the running gear is deactivated and retracted into the parking position.



AUTO CONTOUR,
ground pressure control
with lateral leveling



Integrated
transport system



ORBIS SD
ORBIS

Robust
and proven.
RU 450 and
CONSPEED.



RU 450: up to 4.50 m working width.

The crop flow concept is based on three large cutting and transport discs rotating counter-directionally to each other. The cut surfaces of the plants rest on the blade and create a self-sharpening effect as they are fed in.

An aggressive crop flow is ensured by the intake auger whose speed can be optimized in line with the set chopping length. The simple construction makes for ruggedness and reliability and has proven itself remarkably well.

- Low power requirement
- Reliable crop transport under all conditions
- Can be switched on and reversed under full load
- Adapts easily with quick coupler

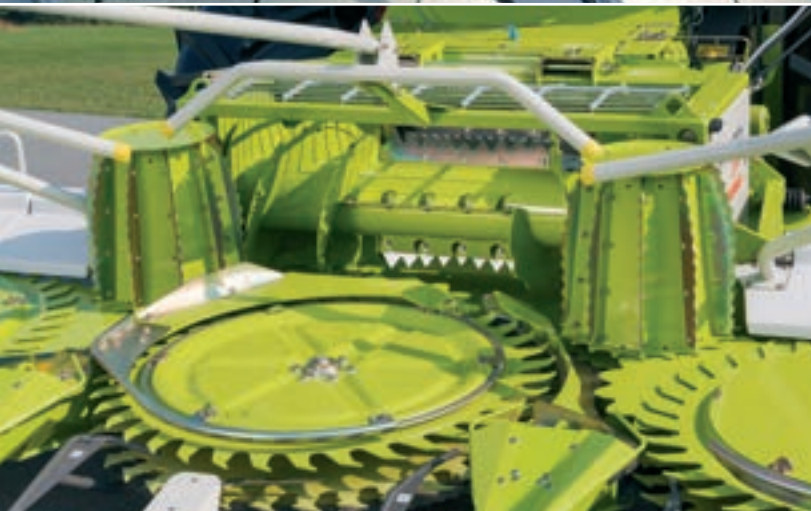



Earlage: harvesting with a corn picker on the JAGUAR.

Earlage is forage with a high energy concentration and is primarily used in cattle farming for milk and meat production.

The following additional equipment is recommended for high-quality whole crop silage (WCS) or earlage silage harvesting:

- WCS / earlage friction bar wedge installed behind the mounting block
- WCS / earlage friction concave plate
- Corncracker with fine meshed rollers and 60 % speed difference

CLAAS adapter.

The adapter makes it possible to attach the CONSPEED corn picker to the JAGUAR.



Corncracker with large speed difference for high-performance crop processing



RU and CONSPEED

Electronic and user-friendly. EASY.

The name says it all.

The combined electronics expertise of CLAAS can be summarized in a word: EASY.

This abbreviation stands for Efficient Agriculture Systems, and it lives up to the name. Equipment settings, guidance systems, software solutions and more: EASY makes it all simple. Your systems can be matched perfectly with each other, enabling you to get the best performance from your machines and top results for your operation.

Go on. Go easy.

The EASY concept comprises four areas – each providing specialist competence and together making a strong team.

- on board – Harvester control and performance optimization from the cab
- on field – Increased productivity directly in the field
- on track – Equipment monitoring and remote diagnosis
- on farm – Software solutions for your operation



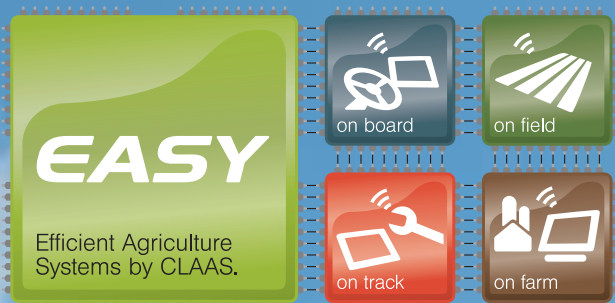

EASY. Equipment options for the JAGUAR.

on board

- CEBIS
- DYNAMIC POWER
- STOP ROCK

on field

- OPTI FILL
- AUTO FILL
- AUTO PILOT
- CAM PILOT
- GPS PILOT

on track

- QUANTIMETER
- Moisture sensor
- Job management
- Yield mapping
- TELEMATICS

on farm

- AGROCOM MAP
- AGROCOM NET



EASY
equipment options

CLAAS TELEMATICS.

Documentation and service online.



A complete overview with just a click of the mouse.

With TELEMATICS, CLAAS lets you retrieve all of your important machine data via the internet, anytime, anywhere – so why not benefit from TELEMATICS yourself?

Optimize your settings.

Compare the performance and job data of your machine in real time and align them precisely with one another for a perfect result in any conditions – each and every day.

Simplify documentation.

With TELEMATICS, you can export relevant data to your field catalog, saving valuable time. For example, you can import data regarding harvest quantities for specific parts of the fields.





Improve work processes.

A report detailing the operating hours analysis and other important machine analyses is sent to you daily by email. This enables you to analyze the precise data from the previous day before starting work, and to determine when and how efficiently your machine has been operating. Additionally, machine movement data can be retrieved with the event log, enhancing transport logistics. TELEMATICS facilitates systematic fleet management and avoids unprofitable downtime.

Faster service – CLAAS remote diagnostics.

With your consent, TELEMATICS can transmit maintenance and repair data to your CLAAS sales partner. This enables your CLAAS partner to carry out an initial analysis via CDS Remote – when required – to find the causes of faults more quickly and to make optimum preparations to assist you on site as quickly as possible.

Automatic Process Data Interpretation (APDI).

APDI automatically documents, interprets and processes all process data. As an extension to TELEMATICS, APDI automatically transfers the work data (without any intervention by the machine operator) to the server, where it is interpreted and processed. Data interpretation and processing are based on the previously uploaded field boundaries from the field file, the EU Single Farm Payment or use of Google Earth®. Further processing is straightforward, as all machine-relevant data can be exported in IsoXML format.

Durable and reliable. PREMIUM LINE.

Now also available ex-factory.

For demanding harvesting conditions PREMIUM LINE offers specially coated and highly wear-resistant parts. The extremely long service life of these parts increases their operating hours significantly. And that saves you time and money.

- 1 Feed roller wear bars
- 2 Drum roller stripper bar
- 3 Wedge behind shear bar
- 4 Sharpening stone
- 5 Drum concave
- 6 Vanes
- 7 Rear wall of grass chute
- 8 Corncracker rollers
- 9 Accelerator paddles
- 10 Accelerator housing, two-part
- 11 Accelerator housing, left / right sides
- 12 Accelerator, rear wall
- 13 Discharge tower, front / rear
- 14 Spout rotation assy., plate
- 15 All spout wear plates





PREMIUM LINE for JAGUAR

For ORBIS. PREMIUM LINE.

- 1 Feed drums
- 2 Guide strips, (steel)
- 3 Transmission cover
- 4 Skids below rotor transmission
- 5 Wear rings below large knife discs
- 6 Scraper, toothed, for large discs
- 7 Scrapers for all discs

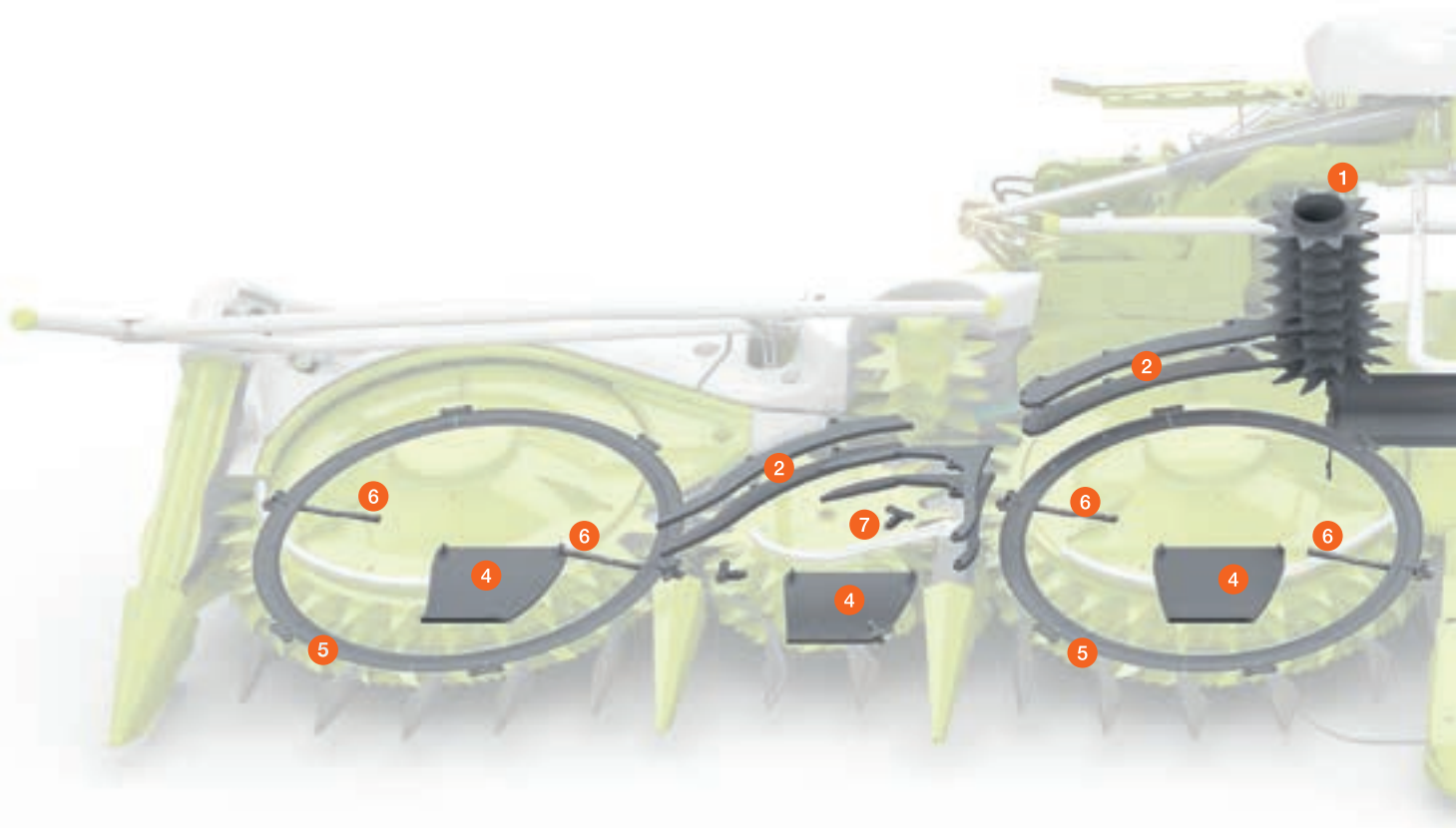

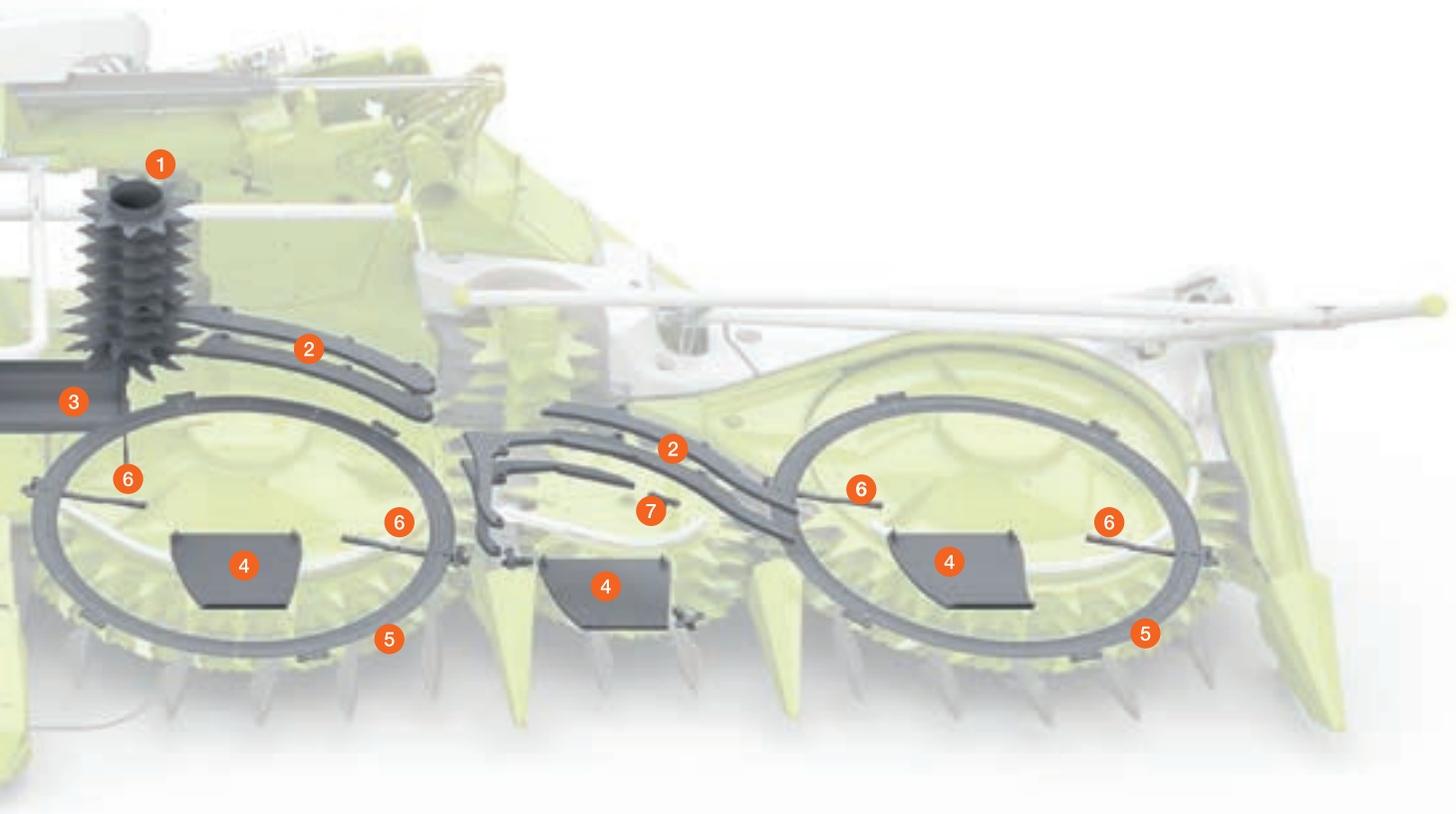

PREMIUM LINE for ORBIS

Quick and straight-forward. Unique maintenance concept.

High operational reliability.

Every minute counts in the short forage harvesting period. Time-consuming maintenance work is a nuisance and also a cost factor, since it reduces the number of productive hours – and also your profit margin. The automatic central lubrication system and combined grinding and shear-bar adjustment function are just two examples of how maintenance times can be reduced and operating times boosted. In addition, you also experience increased reliability during the season with highly wear-resistant components used throughout the crop flow of the JAGUAR. So your JAGUAR is always right where it belongs: out in the field, doing what it does best – working hard.



Ease of access to knife drum



Extremely maintenance-friendly design.

- Once the housing has been opened, you have a perfect view of the knives and shear bar
- It takes just ten minutes to separate the knife drum and the intake on the JAGUAR
- Important engine maintenance is carried out quickly; all service points can be accessed easily from all four sides
- The automatic central lubrication unit with storage for eight liters of grease is sufficient for around 120 hours of operation
- Large side panels allow unrestricted access to the cooling system, the corncracker and the accelerator
- The corncracker can be removed quickly and easily
- If maintenance is needed, the accelerator can also be removed by two people in the space of an hour
- The on-board compressed air supply can be used for many different cleaning tasks
- The service lighting makes it possible to carry out maintenance work during the evening hours, too



Maintenance



Around-the-clock assistance.

You can count on the professional and reliable support of the First CLAAS Service Team at every stage. CLAAS importers and dealers provide fast spare parts supply and reliable customer service worldwide.

Service is close even when far away.

CLAAS TELEMATICS remote diagnostics saves you and us valuable time. This outstanding feature grants our service staff direct access to all the performance and electronics data of your JAGUAR via the Internet. Similarly, a problem can often be solved remotely too. If an on-site visit is still necessary, we have all the information we need, and can bring the necessary replacement parts with us.

We speak the same language.

CLAAS sales partners include some of the foremost agricultural engineering companies worldwide. They are superbly trained and equipped, extremely well acquainted with the way you work and have a thorough understanding of your expectations regarding professional expertise and reliability.

We're there for you wherever you need us.

Our central spare parts warehouse delivers all CLAAS ORIGINAL parts quickly and reliably throughout the world. The extensive network of CLAAS dealers ensures that they reach their destination as quickly as possible – wherever you happen to be.



Very close. CLAAS Service.

For peace of mind. CLAAS service products.

Increase reliability, minimize the repair and breakdown risk, base your calculations on predictable costs. With CLAAS service products you can create your own service package from a range of components. Three products are available:

- CLAAS Post-harvest check
- CLAAS CARE
- CLAAS MAXI CARE

The benefits at a glance:

- Longer machine service life
- Professionally equipped dealer workshop
- Advice on specialist equipment and retrofitting
- Your machine maintained in top working condition
- Downtime minimized
- Fixed cost planning
- Long-term value retention
- Recommended use of CLAAS ORIGINAL parts and service products



First CLAAS Service

Save on the ideal array of equipment. The AUTO FILL package.

To make it easier for you to choose between different items of optional equipment, we are pleased to offer the AUTO FILL equipment package for our JAGUAR models. Our experts have put this package together on the basis of our customers' requirements. You benefit from a set of components which ideally complement each other and from the attractive pricing of this package.

Information about availability and other special package offers is available from your distributor.

The AUTO FILL package comprises:

AUTO FILL.

- Automatic filling of transport vehicles
- Additional lighting

OPTI FILL.

- Parallel guidance of end flaps in the harvest direction
- 70 cm swivel action triggered by a single touch on the operating lever
- Automatic return of spout to transport position
- Two spout swivel positions (e.g. right/left) can be stored

Spout lighting

- Lighting swivels with the spout in the direction of crop discharge
- Rear camera: monitor switches automatically to show rear camera image when reversing



JAGUAR 800

		870	860	850	840
Engine					
Manufacturer		Mercedes-Benz	Mercedes-Benz	Mercedes-Benz	Mercedes-Benz
Type		OM 502 LA	OM 502 LA	OM 460 LA	OM 460 LA
Cylinders		V8	V8	S6	S6
Displacement	l	15.93	15.93	12.82	12.82
Rated speed	rpm	2080	2080	2080	2080
Emissions standard Stage IIIB (Tier 4i)					
Engine output at working speed of 1800 rpm (ECE R 120)	kW (hp)	440 (598)	375 (510)	335 (455)	294 (400)
Fuel tank + auxiliary tank	l	1000 + 300	1000 + 300	1000 + 300	1000 + 300
Urea tank	l	130	130	130	130
Fuel consumption measurement		o	o	o	o
DYNAMIC POWER		o	o	–	–
Running gear					
Traction drive: 2-speed OVERDRIVE transmission, automatic (hydrostatic)		●	●	●	●
Steering axle, standard		●	●	●	●
Steering axle, 3 x adjustment, distance btw. axle flanges (wheel mounting face)	mm	2470/2930/3090	2470/2930/3090	2470/2930/3090	2470/2930/3090
Steered drive axle, POWER TRAC, mechanical		o	o	o	o
Water / silage additive tank	l	375	375	375	375
ACTISILER 20, highly concentrated	l	20	20	20	20
Automatic lowering and CONTOUR ground pressure control		●	●	●	●
Front attachments					
Corn header, row-independent, ORBIS / RU (rows / width)	r/m	10/7.5, 8/6, 6/4.5	10/7.5, 8/6, 6/4.5	8/6, 6/4.5	8/6, 6/4.5
PICK UP 300 / 380	m	2623/3599	2623/3599	2623/3599	2623/3599
DIRECT DISC 520 direct cut header	mm	5125	5125	5125	5125
Crop flow					
Intake width	mm	730	730	730	730
No. of intake and compression rollers		4	4	4	4
Knife drum, width	mm	750	750	750	750
Knife drum, diameter	mm	630	630	630	630
Knife drum, speed at rated speed	rpm	1200	1200	1200	1200
V-CLASSIC drum (20 knives)		V20	V20	V20	V20
Chop lengths, 6-step mechanical	mm	5/6.5/8.5/ 11/17/21	5/6.5/8.5/ 11/17/21	5/6.5/8.5/ 11/17/21	5/6.5/8.5/ 11/17/21
V-CLASSIC drum (24 knives)		V24	V24	V24	V24
Chop lengths, 6-step, mechanical	mm	4/5.5/7/9/14/17	4/5.5/7/9/14/17	4/5.5/7/9/14/17	4/5.5/7/9/14/17
V-CLASSIC drum (28 knives)		V28	V28	V28	V28
Chop lengths, 6-step, mechanical	mm	3.5/4.5/6/8/12/15	3.5/4.5/6/8/12/15	3.5/4.5/6/8/12/15	3.5/4.5/6/8/12/15
Automatic knife sharpening from cab		●	●	●	●
Automatic adjustment of shear bar from cab		o	o	o	o
INTENSIVE CRACKER M (D = 196 mm)		o	o	o	o
MULTI CROP CRACKER M (D = 196 mm)		o	o	o	o
MULTI CROP CRACKER L (D = 250 mm)		o	–	–	–
Crop accelerator, width	mm	680	680	680	680
Crop accelerator, diameter	mm	540	540	540	540
Crop accelerator, mechanical clearance setting		o	o	o	o
Discharge spout, breakback protection		●	●	●	●
Discharge spout, swivel angle, standard	degrees	210	210	210	210
Discharge spout, swivel angle with OPTI FILL / AUTO FILL	degrees	225	225	225	225

● Standard ○ Optional – Not available

JAGUAR 800

		870	860	850	840
Discharge spout S (up to DD 250)					
Discharge spout, extension, M (ORBIS 600)	mm	1 x 750 = 750	1 x 750 = 750	1 x 750 = 750	1 x 750 = 750
Discharge spout, extension, L (ORBIS 750)	mm	2 x 750 = 1500	2 x 750 = 1500	2 x 750 = 1500	2 x 750 = 1500
EASY features					
OPTI FILL, optimized spout control		o	o	o	o
AUTO FILL, automatic trailer filling		o	o	o	o
STOP ROCK, stone detector		o	o	o	o
QUANTIMETER, throughput measurement		o	o	o	o
QUANTIMETER + continuous moisture measurement		o	o	o	o
Job management		o	o	o	o
Yield mapping		o	o	o	o
TELEMATICS		o	o	o	o
AUTO PILOT, central sensors (maize)		o	o	o	o
CAM PILOT, swath recognition (grass)		o	o	o	o
GPS PILOT		o	o	o	o
Maintenance					
Central lubrication, grease reservoir capacity 8 l		o	o	o	o
Service lighting		o	o	o	o
VISTA CAB					
A/C-MATIC air conditioning		o	o	o	o
CEBIS color monitor		●	●	●	●
Printer		o	o	o	o
Standard seat		o	o	o	o
Comfort seat		o	o	o	o
Swiveling seat		o	o	o	o
High-comfort seat, ventilated, heated		o	o	o	o
Passenger seat		●	●	●	●
Basic machine without front attachment					
Working length	mm	6495	6495	6495	6495
Working height with discharge spout extension L	mm	5450	5450	5450	5450
Transport height	mm	3897	3897	3897	3897
Transport length with discharge spout extension L	mm	8015	8015	8015	8015
Weight on standard tires without front attachment	kg	11300	11300	11050	11050
Tires					
Drive axle, transport width by tire size					
650/75 R32	mm	2990	2990	2990	2990
710/70 R32	mm	3180	3180	3180	3180
800/75 R32	mm	3299	3299	3299	3299
900/55 R32	mm	3490	3490	3490	3490
Steering axle, transport width by tire size					
16.5/85-24 14PR	mm	2845	2845	2845	2845
540/65 R24	mm	2960	2960	2960	2960
600/55-26.5	mm	3120	3120	3120	3120

● Standard ○ Optional – Not available

CLAAS continually develops its products to meet customer requirements. This means that all products are subject to change without notice. All descriptions and specifications in this brochure should be considered approximate and may include optional equipment that is not part of the standard specifications. This brochure is designed for worldwide use. Please refer to your nearest CLAAS dealer and their price list for local specification details. Some protective panels may have been removed for photographic purposes in order to present the function clearly. To avoid any risk of danger, never remove these protective panels yourself. In this respect, please refer to the relevant instructions in the operator's manual. All technical specifications relating to engines are based on the European emission regulation standards: Stage. Any reference to the Tier standards in this document is intended solely for information purposes and ease of understanding. It does not imply approval for regions in which emissions are regulated by Tier.

JAGUAR. The only choice.

Here's why:

- Spacious, high-comfort VISTA CAB with excellent all-around visibility
- CEBIS for easy operation and fast monitoring of all key machine data
- Mechanical drive for front attachments with convenient quick coupling system for power transmission
- Standardized front attachment interface to JAGUAR 900 Series allows easy use of front attachments on both machine types
- Direct drive to the chopping mechanism for highly efficient power transmission with low fuel consumption
- Quick-stop brake for the main drive, chopping mechanism stops quickly to provide high level of safety
- Optimum straight crop path from the intake rollers to the accelerator
- Powerful, robust intake with overload protection, metal detector and STOP ROCK stone detector
- V-CLASSIC knife drum with precise cutting action for perfect chop quality
- Easily accessible corncracker for perfect processing of the kernels and fast adaptation to changing field conditions
- Crop accelerator with adjustable distance to rear wall for increased efficiency
- Silage additive metering based on throughput and dry matter content
- EASY features such as AUTO FILL, CAM PILOT etc. for significant reduction in operator workload
- Powerful Mercedes-Benz engines with low diesel consumption
- Large diesel tank capacity for long work days
- Outstanding accessibility for fast and straight-forward maintenance
- PREMIUM LINE – highly wear-resistant parts in the JAGUAR crop-flow and in ORBIS
- First CLAAS Service around the clock



CLAAS of America Inc.

8401 S. 132nd Street

Omaha NE 68138

Phone +1 (402) 861-1000

Fax +1 (402) 861-1003

claasofamerica.com

HRC / 202012951014 KK DC 0515