

All information in this Owner's Manual is the newest publication based on the current models. However, JAC reserves the right to make changes at any time so that our police of continual product improvement may be carried out.

This manual applies to all current JAC models and includes description and explanation of option as well as standard equipment. As a result, you may find material in this manual that does not apply to your specific vehicle.

## FOREWORD

Thank you for choosing JAC Medium Trucks. We are pleased to welcome you to join into JAC family. The advanced engineering and high-quality construction of each JAC we build is something of which we are proud.

This Owner's Manual will introduce you to the features and operation of your new vehicle. It is suggested that you read it carefully since the information it contains can contribute greatly to the satisfaction you receive from your new vehicle.

The manufacturer also recommends that all service and maintenance on your vehicle be performed by an authorized JAC service station. JAC service stations are prepared to provide high-quality service, maintenance and any other assistance that may be required.

ANHUI JIANGHUAI AUTOMOBILE CO., LTD.

Note: Because future owners will also need the information included in this manual, when you sell this vehicle, please leave it in the vehicle for their use. Thank you.

The manual has been edited on the basis of the truck air over hydraulic brake, left-hand drive vehicle. On the other models, only the differences have been covered. Some illustrations may not coincide with your vehicle, but the contents of explanations are common. The material in this publication may not be reproduced in any form without written permission from the JAC Motor Company.

## SAFETY AND VEHICLE DAMAGE WARNING

This manual includes information titled as WARNING, CAUTION and NOTE. These titles indicate the following:

### WARNING:

This indicates that a condition may result in harm or injury to you or other persons if the warning is not heeded. Follow the advice provided with the warning.

### CAUTION:

This indicates that a condition may result in damage to your vehicle or its equipment if the caution is not heeded. Follow the advice provided with the caution.

### NOTE:

This indicates that interesting or helpful information is being provided.

## CONTENTS

BEFORE DRIVING YOUR VEHICLE.....	1
INSTRUMENTS & CONTROLS .....	10
STARTING & OPERATING .....	59
IN CASE OF EMERGENCY .....	79
APPEARANCE CARE.....	90
VEHICLE MAINTENANCE REQUIREMENTS .....	95
CONSUMER INFORMATION.....	115

# BEFORE DRIVING YOUR VEHICLE

#### BREAKING IN YOUR VEHICLE

Operate the vehicle at moderate speeds during the first 1,000 km (600 miles) to break it in. Make certain that the following points in particular are strictly observed.

- Allow the engine to warm up fully until the coolant temperature reaches about 60(140°F).
- Avoid racing the engine, abrupt start, acceleration and braking.
- Avoid overloading the vehicle, as this will result in a shorter life.
- Avoid high speed operation as far as possible. During break-in operation, make sure that the engine speed does not exceed 1,500 rpm.

#### KEYS

For greater convenience, JAC provides two keys of one type. The keys will be function in the ignition, locking or unlocking the door and fuel tank cap from outside. Carrying a spare key is recommended in case you accidentally lock one key inside the car.

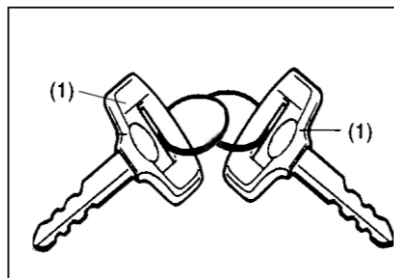

DOOR LOCKS  
1.Locking using the key

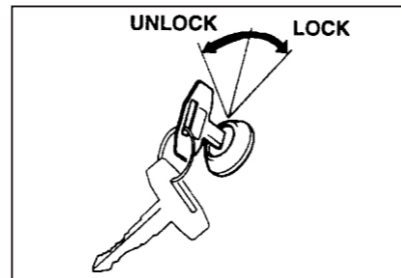

Lock the door by turning the key toward the rear of the car and unlock it by turning it toward the front.

#### CAUTION:

Be careful not to lock the door with the ignition key left in the vehicle.

#### 2. Locking from inside

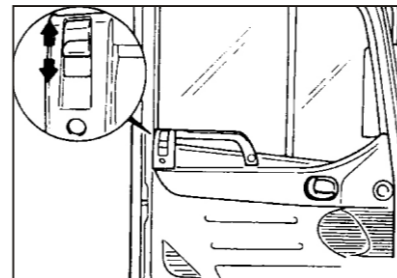

To lock your JAC from inside, simply close the door and push the lock button down. When this is done, the door cannot be opened using either the inside or the outside door handle.

#### NOTE:

When the door is open or ajar, the door warning lamp will light on.

#### 3. Locking from outside

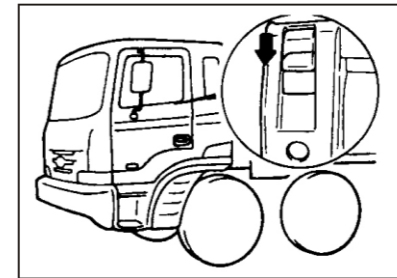

The doors can be locked without a key.

First push the lock knob down, then close the door.

#### WINDOW GLASS Manual window

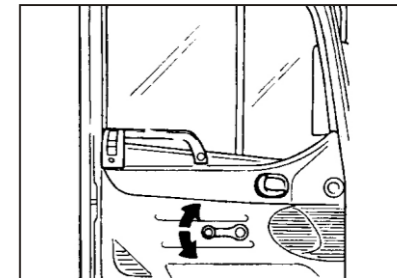

To raise or lower the window, turn the window regulator handle clockwise or counterclockwise.

#### WARNING:

When opening or closing the windows, make sure your passenger's arms and hands are safely out of the way.



#### Electric window (optional)

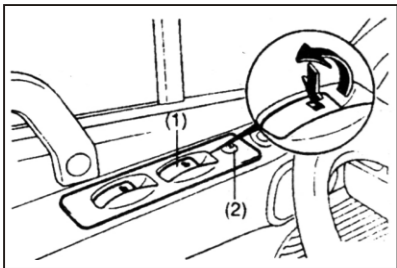

When turning the engine ignition key to the position "ON", the electric window can be regulated. The main switch is installed on the driver's side door, which can also be used to control the passenger's side door. When pressing down/pulling up the corresponding button, the window will be opened/closed. To open the driver's side window, please press down the switch (1) by half stroke,

and the corresponding glass will be lowered down; once the hand moves away, the glass will stop moving. To completely and automatically open the driver's side window, please press down the switch (1) to the limiting position. In such case, even loosening the switch, the window will be automatically lowered down to the limiting position. If just opening the window (not completely), the switch (1) can be pulled up halfway and then loosened. The auxiliary switch is installed on the passenger's side door, which can only be used to control the passenger's side window. To ensure that the driver can limit the passenger's switch operation, the button lock (2) is installed on the

main switch; when this button is pressed down, the passenger's side auxiliary switch will be disabled.

There are two kinds of electric windows: One kind can be regulated within 30s after turning the ignition key to "ACC" or "LOCK", but it can't be regulated when opening the door. Another kind can't be regulated when turning the ignition key to "ACC" or "LOCK".

#### WARNING:

- When closing the window, please pay high attention to head, hands and body of the passenger.
- Please don't simultaneously operate the main switch and auxiliary switch in the opposite direction to control

the passenger's side window; or else, the window can't be opened or closed.

- Don't leave the child in the vehicle alone. For safety, when leaving the cab, you are recommended to remove the ignition key.

#### STEERING WHEEL TILT LEVER

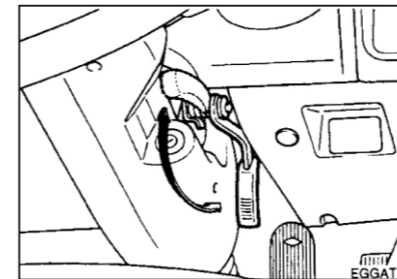

To adjust the steering wheel:

1. Pull the lever upward to unlock.
2. Raise or lower the steering wheel to the expected position.
3. After adjustment, securely tighten the lever by pushing it downward.

#### WARNING:

Do not attempt to adjust the steering wheel while driving as this may result in losing control of the vehicle and thereafter death or serious injury.

#### ADJUSTABLE SEAT

#### WARNING:

Never attempt to adjust the seat while the vehicle is moving. It is very dangerous.

Adjusting seat forward and rearward (driver's side only)

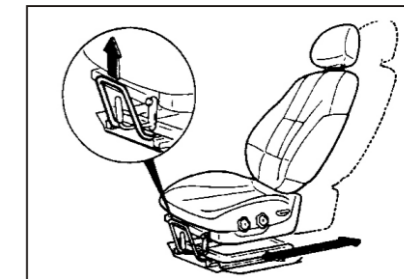

To move the seat toward the front or rear, pull the lock release lever upwards. This releases the seat on its track so you can move it forward or rearward to the expected position. When you find the position you want, release the lever and slide the seat forward or rearward on its track until it locks into position and cannot be moved further.

Seat cushion height fixing  
(driver's side only)

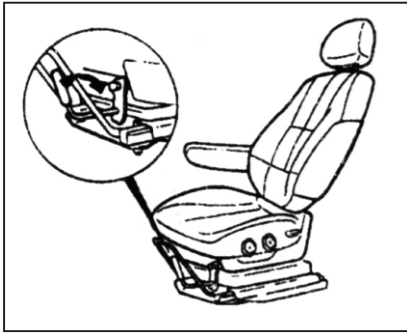

To fix the height of the seat cushion, fit the locking knob to the locker. It will hold your seat position from the vibration.

Adjusting armrest angle (optional)

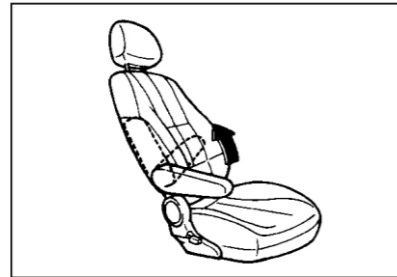

The armrest will be raised or lowered manually.

To raise the armrest, pull it up.

To lower it, press the armrest down.

Adjusting seatback angle

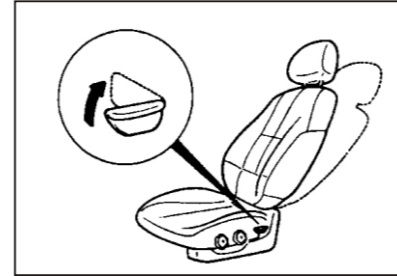

To adjust the seatback, lean forward to make sure your weight is off it, then pull up the recliner control lever at the outside edge of the seat. Now lean back until the expected seatback angle is achieved. Release the recliner control lever to lock the seatback into position.

**WARNING:**

To reduce personal injuries due to traffic collision or emergency brake, both the passenger's and driver's backrest angle shall be about 90° during driving; in this way, the safety belts can take good effect. There is great risk that the passenger will slide out of the belt resulting in serious injury when the seatback is reclined.

Adjustable headrests(optional)

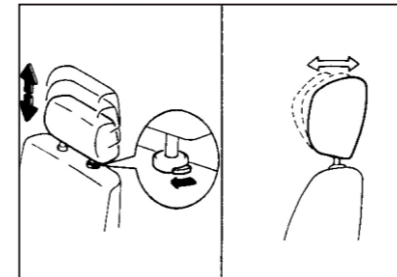

The headrests in your JAC may be raised or lowered by releasing the lock button on the headrest support. To raise the headrest, pull it up. To lower it, press the headrest down. To move the headrest forward, pull on the top. For maximum effectiveness in an accident please adjust the height of the headrest to the top of the occupant's ears. So, the cushion that holds the body away from the seatback should not be used.

**WARNING:**

Do not operate vehicle with the headrests removed as injury to an occupant may occur in an accident. Headrests may provide protection against neck injuries when properly adjusted.

Seat cushion height adjustment  
(driver's seat only)

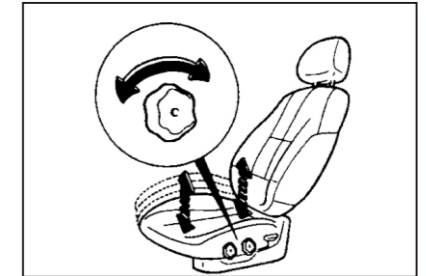

To raise or lower the front part of the seat cushion, turn the front knob forward or rearward. To raise or lower the rear part of the seat cushion, turn the rear knob forward or rearward.

Safety belt height adjustment  
(just the driver's seat)

To get a safer and more comfortable safety belt, its fixing point can be adjusted. By pushing the handle upwards or downwards, the safety belt can be adjusted to your ideal height.

**WARNING:**

During driving, the height adjuster shall be locked.

**SAFETY BELTS (3-POINT TYPE)**

To fasten seat belt



To fasten your safety belt, pull it out of the retractor and insert the metal tab into the buckle. There will be an audible 'click', when the tab locks into the buckle.

The safety belt automatically adjusts to the proper length only after the lap belt is adjusted manually so that it fits snugly around your hips. If you lean forward in a slow, easy motion, the belt will extend and let you move

around. If there is a sudden stop or impact, however, the belt will lock. It will also lock if you try to lean forward too quickly.

Check to make sure the belt is properly locked and the belt is not twisted.

**NOTE:**

If the driver's safety belt is not fastened when the ignition key is in the 'ON' position, the seat belt warning light will flash.

Adjusting your safety belt

You should place the belt as low as possible on your crotch, not on your waist. If located too high on your body, the chances of sliding out from it and suffering serious injury or death are increased. Both arms should not be under or over the belt at the same time. But, one should be over and the other under, as shown in the illustration.

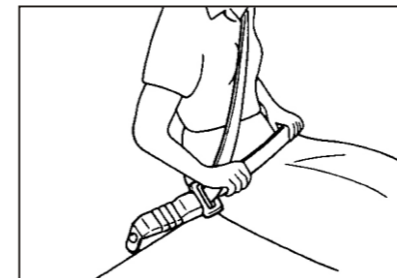

To release the safety belt

The safety belt is released by pressing the release button in the locking buckle. When it is released, the belt should be drawn back into the retractor automatically.

If this does not happen, check the belt to make sure it is not twisted, then try it again.



## INSTRUMENTS&CONTROLS

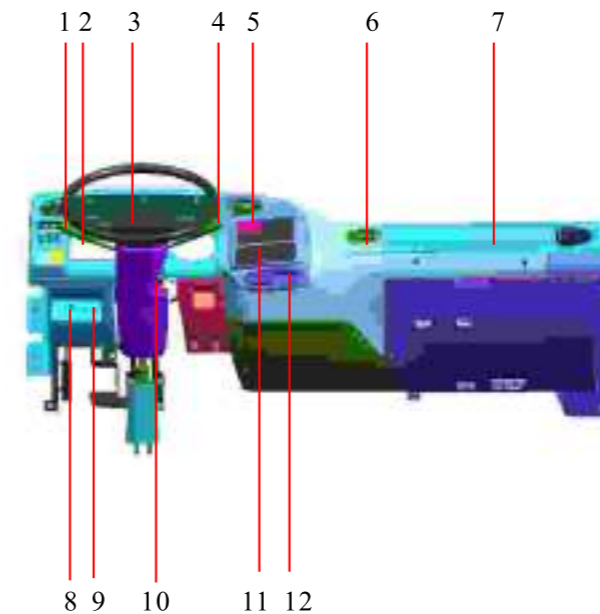

1. Head light/ High & Low beam/turn signal switch
2. Control switches
3. Horn button
4. Wiper & washer/exhaust brake switch
5. Control switches
6. Wind vent(air condition)
7. Fuse box
8. Cigarette lighter
9. Hand throttle drawing handle (EIII and EVI W/O )
10. Start switch
11. Air conditioner control switches
12. Digital clock

## INSTRUMENT CLUSTER AND INDICATOR

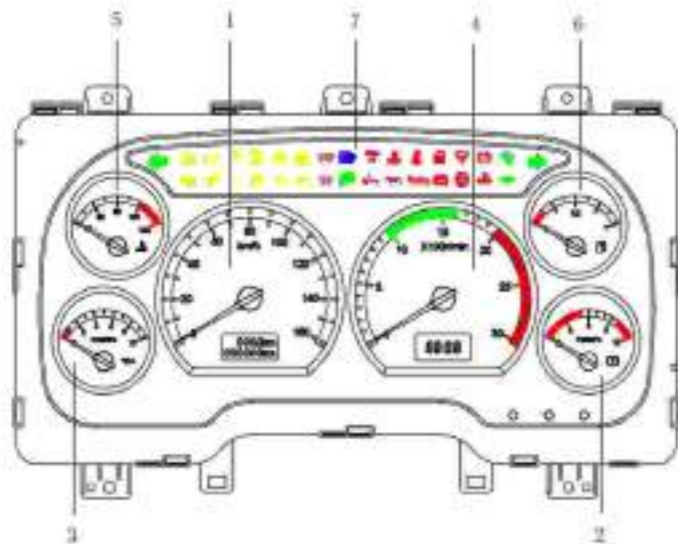

1. Speedometer
2. Air pressure gauge
3. Oil pressure gauge
4. Tachometer
5. Water temperature gauge
6. Fuel gauge (Urea level gauge)
7. Instruments Indicator light

## TACHOMETER



The tachometer registers the speed of your engine in revolutions per minute (rpm). It is useful to help you shift at the appropriate engine speed to avoid lugging or over running.

There is one urea level gauge type with the full scale of 3,100r/min and alarm scale of 2,700r/min; when the engine speed is higher than 2,700r/min, the buzzer will send

alarm. In addition, the tachometer can also be used as an electronic clock.

### CAUTION:

The engine should not be raced at such a speed that the needle enters the red zone on the tachometer face. This can cause severe engine damage.

## SPEED/ODOMETER

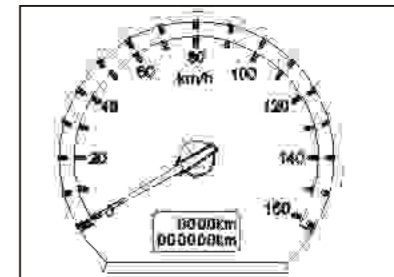

### Speedometer

The speedometer indicates the vehicle speed in kilometers or miles per hour.

### Odometer

The odometer records the total driving distance in kilometers or miles, and is useful for keeping a record for maintenance intervals.

#### AIR PRESSURE GAUGE

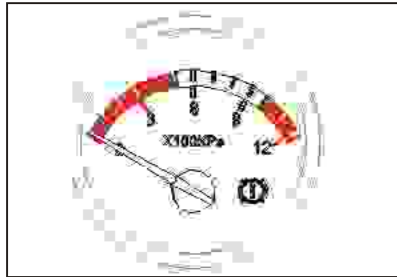

#### CAUTION:

If the air pressure gauge indicates that the pressure is below red zone, do not drive the vehicle. This is very dangerous.

The air pressure gauge indicates the air pressure in the air reservoir at all times.

If the air pressure drops to below 500KPa, the air pilot light comes on and the warning buzzer will sound at the same time. If it fails to build up again, stop the engine immediately and contact your authorized service station.

#### FUEL GAUGE(Urea level Gauge)

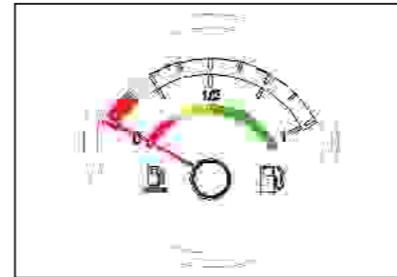

The fuel gauge will indicate the approximate fuel level in the tank, when the ignition is in the "ON" position.

The position of the pointer will vary slightly when accelerating, braking, or when the vehicle is going up or down hill. So check your fuel supply when it is moving or not.

#### WATER TEMPERATURE GAUGE



#### NOTE:

The fuel gauge is up to Euro IV Emission Standard vehicle. Additional, it has the urea level indication function. No matter the fuel indication or urea level indication, when the needle points to the red area, it means fuel or urea shall be filled.

When the ignition switch is "ON", this gauge indicates the temperature of the coolant. In most driving conditions, the needle will remain at approximately the halfway point. Stopping, starting, driving at high speed during warm weather or driving up a steep gradient may cause the pointer moving toward the red sector. If your vehicle overheated, water lamp comes and

the indicator goes up. However when the quantity of coolant is below the specification, the warning buzzer will sound.

At this time, stop your vehicle immediately.



### OIL PRESSURE GAUGE



The gauge indicates the engine oil pressure while the engine is running.

If the engine oil pressure is below 100KPa, oil warning lamp will come on and buzzer will sound at the same time.

At this situation, stop the engine immediately and check the lubricating system.

#### NOTE:

If the engine is cold, the engine oil pressure may go up above normal. If the engine is warm, the gauge will indicate normal pressure immediately.

If the oil filter is clogged, the oil pressure warning light comes on but the buzzer will not sound.

### INDICATOR LIGHTS

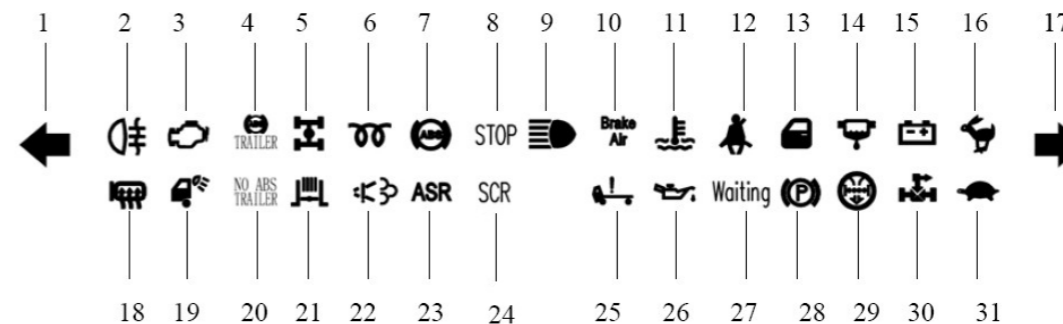

- |   |   |                                    |
|---|---|------------------------------------|
| 1. Left turn lamp                       | 12. Safety belt indicator lamp              | 22. OBD indicator lamp             |
| 2. Rear fog lamp                        | 13. Door alarm lamp                         | 23. ASR indicator lamp             |
| 3. Engine malfunction indicator lamp    | 14. Oil-water separation indicator lamp     | 24. SCR indicator lamp             |
| 4. Trailer ABS detection indicator lamp | 15. Charging indicator lamp                 | 25. Cab locking indicator lamp     |
| 5. Differential lock indicator lamp     | 16. High gear indicator lamp                | 26. Engine oil pressure alarm lamp |
| 6. Engine preheating indicator lamp     | 17. Right turn lamp                         | 27. Engine waiting indicator lamp  |
| 7. ABS alarm lamp                       | 18. Rear-view mirror heating indicator lamp | 28. Parking brake indicator lamp   |
| 8. Engine stop indicator lamp           | 19. Working lamp indicator lamp             | 29. Filter indicator lamp          |
| 9. Upper beam indicator lamp            | 20. Trailer NO ABS indicator lamp           | 30. PTO indicator lamp             |
| 10. Low pressure indicator lamp         | 21. Exhaust brake indicator lamp            | 31. Low gear indicator lamp        |

PTO indicator lamp (optional)

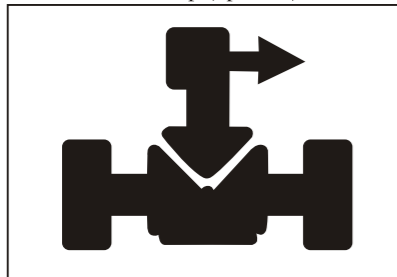

When turning on PTO switch, PTO indicator lamp will be on.

**NOTE:**

During driving, please don't operate the switch; or else, all parts for power transmission may be damaged.

Rear-view mirror heating indicator lamp (optional)

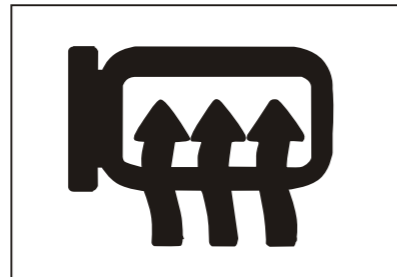

When turn on the rear-view mirror heating switch, the exterior rear-view mirror glass will be heated and the rear-view mirror heating indicator lamp will be on.

Parking brake indicator lamp



When the ignition switch is turned on and the parking brake is not released, the parking brake indicator lamp will be on. When loosening the parking brake, the parking brake indicator lamp will be off. Only when the parking brake is released and the parking brake indicator lamp is off, the vehicle can be started.

Upper beam indicator lamp

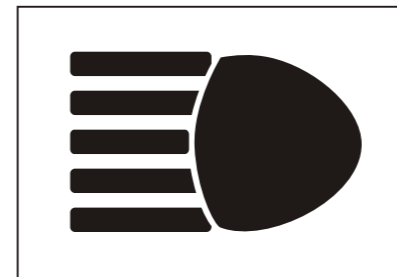

When the headlamp switch is turned to the upper beam, the upper beam indicator lamp will be on.

Turn indicator lamp

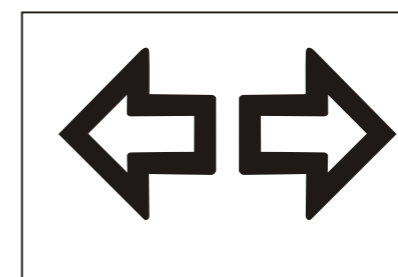

There is one green flashing arrow on the dashboard, which is used to show the turn direction displayed by the turn signal lamp. If the arrow is on without flashing, the turn lamp may have too high flashing frequency or it doesn't flash at all; in such case, please check the turn signal system for the malfunction.

Engine oil pressure indicator lamp

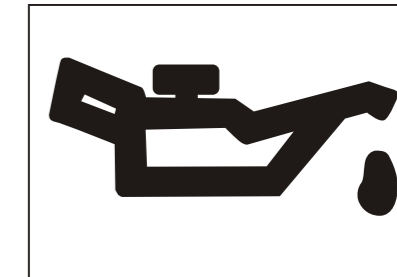

When turn the ignition switch to position "ON", the indicator lamp will be on; however, it will be off after starting the engine. If the indicator lamp is still on after starting the engine, please immediately stop the vehicle and contact with the nearest service station.



Safety belt indicator lamp



When turning on the ignition switch, the safety belt indicator lamp will flash for about 5s to remind the driver of fastening the safety belt. If the driver fastens the safety belt within 5s, the indicator lamp will be off. When turning the ignition switch to the position "ACC" or "LOCK", the indicator lamp will be off as well.

Filter indicator lamp (optional)



When the air filter is too dirty and needs maintenance, the filter indicator lamp will be on. When the filter indicator lamp is on, the filter maintenance shall be done according to the maintenance requirements.

Overheating engine water indicator lamp



If the coolant temperature is too high, the indicator lamp will be on; if the coolant is insufficient, the alarm buzzer will give alarm. In such case, please stop to the roadside, then check the coolant level. If necessary, please fill in coolant till the level is between the lowest and highest marks.

Engine preheating indicator lamp

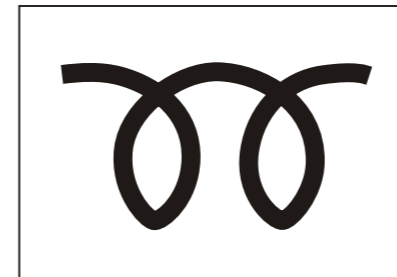

When turning the ignition switch to position "ON" in cold seasons, the lamp will be on, please keep the switch at this position till the indicator lamp is off. When the lamp is off, please turn the switch to position "START", and the vehicle can be started.

Working lamp indicator lamp (optional)



When turning on the working lamp switch, the indicator lamp will be on. After finishing the work or driving the vehicle at normal speed, please turn off the switch.

Low gear indicator lamp

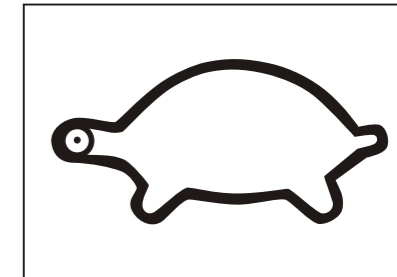

When the auxiliary transmission is at the low gear position, the indicator lamp will be on.

High gear indicator lamp



When the auxiliary transmission is at the high gear position, the indicator lamp will be on.

Exhaust auxiliary brake indicator lamp

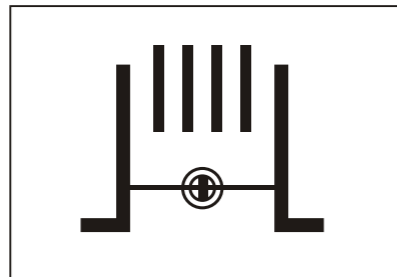

When turning on the exhaust auxiliary brake switch, the indicator lamp will be on; when resetting the switch, the indicator lamp will be off.

ABS indicator lamp(optional)



When turning the key to position "ON", ABS indicator lamp will be on, which will be off automatically after several seconds. If ABS indicator lamp is normally on during driving or ABS indicator lamp is still on after turning the key to position "ON", it means that ABS may have malfunction; in such case, you are recommended to immediately contact with the dealer for check.

Cab locking indicator lamp



When the cab latch hook is not locked, the indicator lamp will be on.

Though ABS has malfunction, the normal braking system is still effective.

ASR indicator lamp (optional)



When turning the ignition key to position "ON", the indicator lamp will be on, which will be off during braking. If still on, it means that ASR

doesn't work.

Once ASR has malfunction, ABS indicator lamp will be on as well.

During normal driving, ASR indicator lamp will be off. When ASR works, ASR indicator lamp will flash.

NOTE:

ASR lamp is yellow and ABS lamp is red. Yellow means indication and red means alarm.

Door alarm lamp



The door alarm lamp is used to warn you that the door is not closed.

**CAUTION:**

During driving, please close all doors.

Before starting, please check if the door alarm lamp is off.

Charging indicator lamp

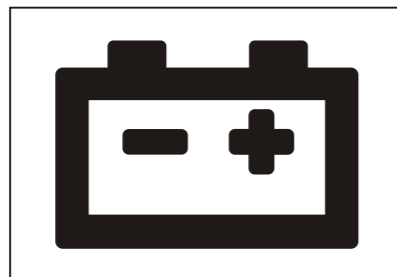

When turning on the ignition key, the charging indicator lamp shall be on; when the engine runs, the charging indicator lamp shall be off. When the charging indicator lamp is still on during driving, you are recommended to stop the vehicle and engine and check the tensioner pulley belt. If the belt is loose or worn out, please adjust or replace it.

Low pressure indicator lamp

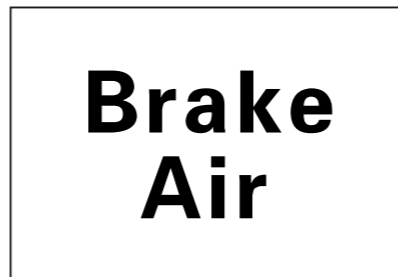

When the engine runs and the air reservoir pressure is lower than 5 100KPa, the indicator lamp will be on and the buzzer will make sound. In such case, you are recommended to immediately stop the vehicle and run the engine at idle speed for a while. When the pressure is qualified and the indicator lamp is off, you can keep on driving.

**CAUTION:**

If you start the vehicle when the low pressure indicator lamp is still on, it will be very dangerous. The pressure recovery needs a very long time, you are recommended to immediately contact with the dealer to check and repair this system.

Rear fog lamp

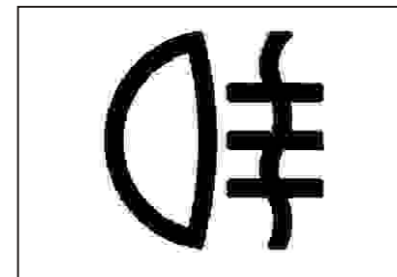

When pressing down the rear fog lamp switch, the lamp will be on, which is used to prompt you that the rear fog lamp is in working state; during driving in foggy days and under the weather with lower visibility, please turn on the lamp.

Engine malfunction indicator lamp  
(available for the model up to Euro III emission standard and above)

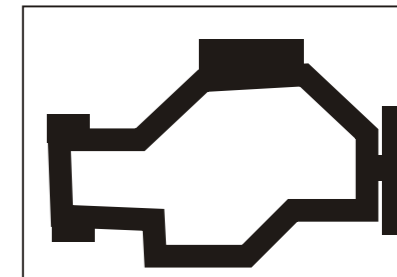

When the engine has malfunction or the oil product is unqualified, the lamp will be on; in such case, you are recommended to immediately drive the vehicle to the adjacent repair service station to completely detect the engine or change fuel.

Trailer ABS detection indicator lamp  
(special for the towing vehicle)



When turning the key to position "ON", ABS indicator lamp will be on, which will be off automatically after several seconds. If ABS indicator lamp is normally on during driving or ABS indicator lamp is still on after turning the key to position "ON", it means that ABS may have malfunction; in such case, you are recommended to immediately

contact with the dealer to check the trailer ABS function.

Though ABS has malfunction, the normal braking system is still effective.

Trailer NO ABS indicator lamp (not available)



Differential lock indicator lamp

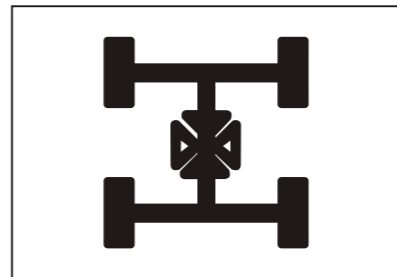

When the differential lock switch is pressed down and the differential lock works, the lamp will be on, which is used to remind you of the active state of the differential lock.

Engine stop indicator lamp (special for Cummins engine)



When the engine has serious hidden malfunction, the lamp will be on. You are recommended to immediately stop the vehicle for check and troubleshooting.

NOTE:

When the lamp is on, please stop the vehicle; or else, the engine may suddenly lose power and lead to safety accident.

Engine waiting indicator lamp (special for Cummins engine)



If turning the ignition switch to position "ON" in cold seasons, the lamp will be on, which is used to remind the driver of starting the vehicle after the engine preheating. The lamp will be on earlier than the preheating indicator lamp, which will be off after the engine preheating begins.

Oil-water separation indicator lamp



When there is too much water content in the fuel filter, the lamp will be on; in such case, please timely remove the water content in the filter for its normal working.

OBD indicator lamp (available for the model up to euro IV emission standard and above)

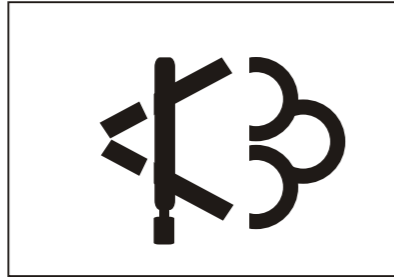

When the vehicle rear treater system has malfunction or the fuel is unqualified and leads to unqualified tail gas emission, the lamp will be on; in such case, you are recommended to immediately drive the vehicle to the adjacent repair service station for check and troubleshooting.

SCR indicator lamp (not available)



The lamp function is similar to that of OBD indicator lamp. The function is unavailable for JAC medium-sized truck.

Instrument button



There are three buttons at the lower right side of the combination instrument: The left one is for instrument mileage subtotal reset; the middle one is for clock down regulation; the right one is for clock up regulation.

TURN SIGNAL, HEADLAMP AND LOWER BEAM COMBINATION SWITCH  
Trun signal switch

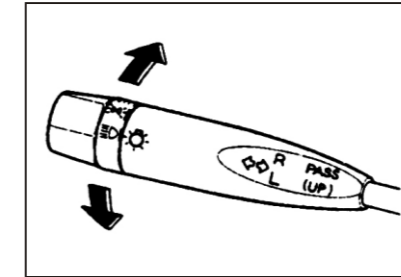

Pulling the lever back(away from you) causes the turn left signals of the vehicle to blink. Pushing the lever forward(toward you) causes the turn right signals of the vehicle to blink. As the turning is completed, the lever will automatically return to the center position and turn off the turn signal at the same time. If either

turn signal indicator light blinks more rapidly than usual, goes on but does not blink, or does not go on at all, there is a malfunction in the system. Check for a burned-out fuse or bulb or contact with our authorized JAC service station.

Headlight switch

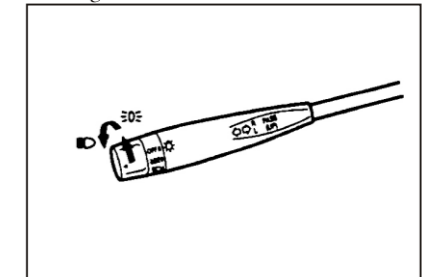

To operate the headlights, turn the barrel on the end of the multifunction

switch. Turn on the parking lights, sidelights, taillights and instrument panel lights in the first position . Turn on the headlights in the second position .

High-beam and low-beam

To turn on the headlight high beams, push the lever upward. For low beams, pull the lever down. The appropriate headlight beam indicator light will come on at the same time.

**NOTE:**

This function is operated when the headlight switch is in the "ON" position.

Passing switch

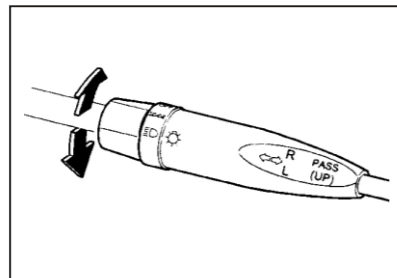

The headlights will be flashed when the lever is pushed upward and release automatically. The headlights can be flashed even though the headlight switch is in the "OFF" position.

Windshield wiper

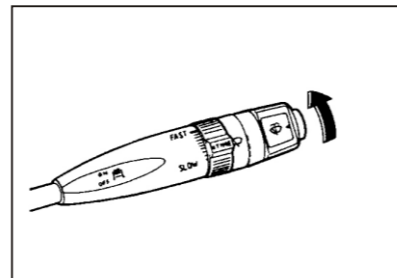

The windshield wiper switch has three positions:

INT: Intermittent wiper operation

LO : Low-speed operation

HI : High-speed operation

**NOTE:**

To prevent damages to the wiper system, do not attempt to wipe away heavy accumulations of snow or ice.

Accumulated snow and ice should be removed manually. If there is only a light layer of snow or ice, operate the heater in the defrost mode to melt the snow or ice before using the wiper.

Windshield washer operation

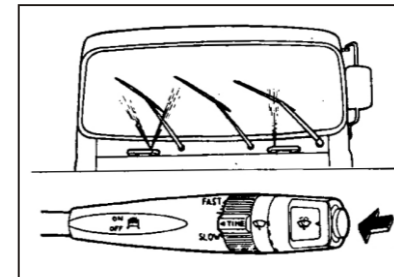

To use the windshield washer, press the button at the end of the wiper/washer lever. When the washer button is pressed, the wipers automatically make two passes across the windshield, and the windshield wiper is operated 2 to 3 times at the same time, The washer continues to operate as long as the button is pressed.

**CAUTION:**

- Do not use the wiper when the windshield is dry.
- The washer button should not be pressed if the washer reservoir is empty. This can damage the washer fluid pump. Do not operate the washer for more than 15 seconds at a time.

#### Exhaust brake switch

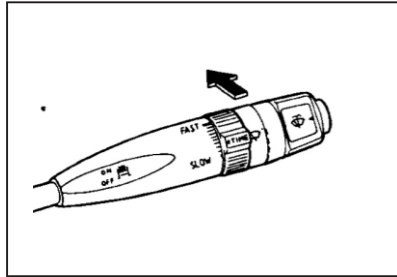

To use the exhaust brake, push the wiper/washer lever forward. The exhaust brake operates when you remove your feet from the accelerator pedal and the clutch pedal. The exhaust brake will not operate automatically if you operate the accelerator pedal or the clutch pedal.

#### NOTE:

Use exhaust brake when going down a slope.

#### HAZARD WARNING

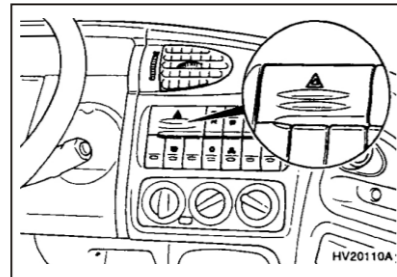

The hazard warning lamp should be used whenever you find it necessary

to stop the car in a hazardous location. When you must make such an emergency stop, park along the roadside closely.

The hazard warning lights are turned on by pushing the hazard switch. This causes all turn signal lights to blink. The hazard warning lights will operate even though the key is not in the ignition.

To turn the hazard warning lights off, push the switch a second time.

#### FOG LAMP SWITCH

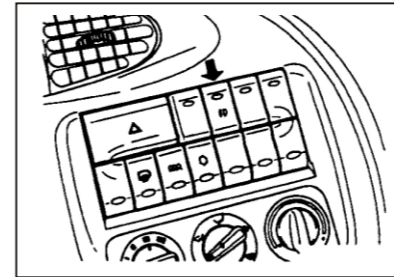

Use the fog lamp when you go through the foggy area. Use the multi-use lever to open the taillights. Press the button to open the foggy lamp. While operating this switch, clearance lamp, tail lamp, license plate lamp, instrument lamps will come on at the same time.

Press the switch one more time and the fog lamp will turn off

#### DIFFERENTIAL LOCK SWITCH (OPTIONAL)

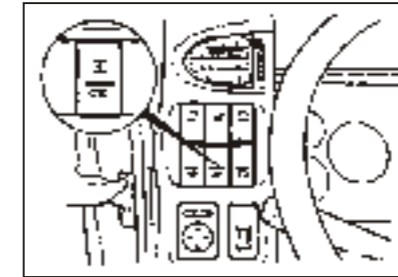

When pressing down the differential lock switch, the intermediate shaft differential will be locked and the differential lock indicator lamp will be on. If pressing down the switch again, the differential lock will be released.

When driving on rough roads, please lock the intermediate shaft

differential; after that, please release the differential lock. If it is difficult to drive the vehicle on uneven roads and the differential lock doesn't work, please stop the vehicle and the rear axle; turn on the differential lock switch, and then restart the vehicle.

#### CAUTION:

- The differential lock switch shall be turned on after stopping the vehicle and rear axle.
- During normal driving, please release the differential lock.
- The rear axle can only be locked for 1 min. at most.
- It may damage the reduction gear and differential.



#### ASR SWITCH (OPTIONAL)

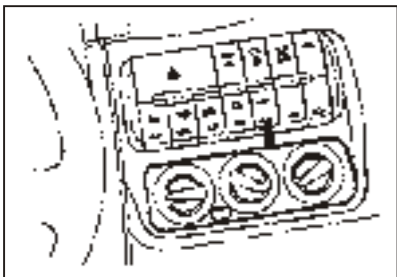

When pressing down ASR switch, ASR system will work. When pressing down the switch again, ASR will be turned off.

When the rear axle is in the mud pit or sand, you are recommended to turn on ASR switch to drive continuously.

#### OUTSIDE REAR VIEW MIRROR HEATER (OPTIONAL)

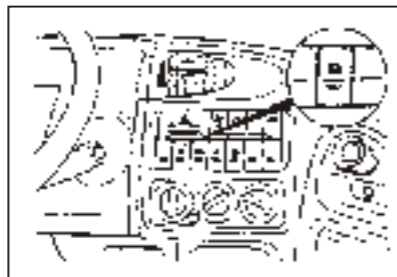

Depress the switch to heat the rear view mirror glass. The rear view mirror glass will be heated for defrosting or defogging and will give you improved rear view in all weather conditions. The outside rear view mirror heater automatically turns itself off after approximately 15 minutes.

#### CIGARETTE LIGHTER

For the cigarette lighter to work, the key must be in the "ACC" position or the "ON" position.

To use the cigarette lighter, push it all the way into its socket. When the element has been heated, the lighter will pop out to the "ready" position. Then you can light your cigarette. Do not press the cigarette lighter in again. This can damage the heating element and create a fire hazard.

#### CAUTION:

After power on, the cigar lighter can be automatically powered off within 18s and reset to normal position;

After being powered off, the cigar lighter can light the cigarette within 10s.

To replace the cigar lighter, please use the original product or approved equivalent substitute.

#### STEERING WHEEL & HORN

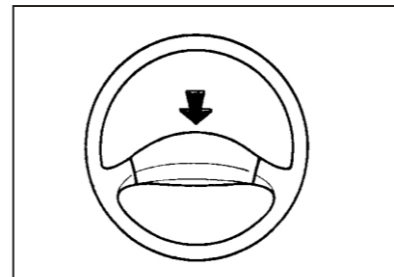

Our JAC is equipped with integral styled steering wheel. The horn button is located in the center of the wheel.

The horn sounds when the horn button is pressed firmly.

#### STARTING THE ENGINE IN WINTER

In cold winter, when the ignition switch is turned to the "ON" position then the amber lamp  will come on. Hold the switch there and wait until the lamp is off. Start the engine.

#### AIR HEATING SYSTEM

The air heating system warms the intake air up in order to start the engine well and decrease white fume is emitted through the exhaust pipe in winter.

When the ignition key is turned to the "ON" position, the system is operated automatically.

If the  lamp is turned on when turning the ignition key to the "ON" position, wait until the lamp is off. And start the engine.

#### CAUTION:

If the  lamp blinks, the air heating relay may be damaged or a fuse blown, Check and replace it.

#### PARKING BRAKE (EXCEPT TRACTOR, PULL CARGO)

Always engage the parking brake before leaving the vehicle. This also turns on the parking brake indicator light when the key is in the "ACC" or "ON" position. Before driving away, be sure that the parking brake is fully released and that the indicator light is off.

To engage the parking brake, pull the lever up.



To release the parking brake, pull up and press thumb button.

**NOTE:**

The buzzer may sound when the parking brake is released. (ONLY TRACTOR, PULL CARGO) If the buzzer sounds, have the brake system checked as follows:

- Check the air pressure in the air reservoir.
- Check the oil leaks from brake system.
- Check the clearance of brake shoes.

**FULL AIR BRAKES**

The full air brake vehicles are equipped with an emergency brake. Should the compressed air pressure fall below 2.7 kg.f/cm<sup>2</sup> (265kPa), spring operated emergency brake is automatically applied to the rear wheels. On tractors, service brakes are applied to the trailer as well.

**INTERIOR LIGHT**  
Cab ceiling lamp

The cab ceiling lamp (interior door control lighting lamp) has two buttons:

When pressing down the "door control" button, no matter where the ignition switch is, the ceiling lamp will be on if the door is opened.

When pressing down the "ceiling lamp" button, the ceiling lamp will be on normally.

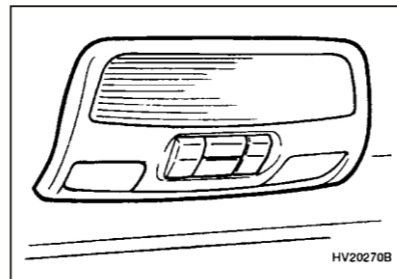

Reading light

The two reading lights have two buttons which located each side of interior light.

**Sleeper light**

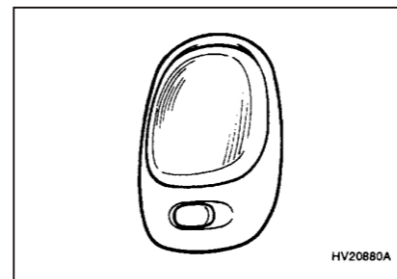

The three positions are:

- DR (•)

In the middle position (•), the interior courtesy light comes on when any door is opened regardless of the ignition key position. The light goes out when the door is closed.

- ON

In the "ON" position, the light stays on all the time.

- OFF

In the "OFF" position, the light stays off all the time even though a door is open.

**HOOD RELEASE**

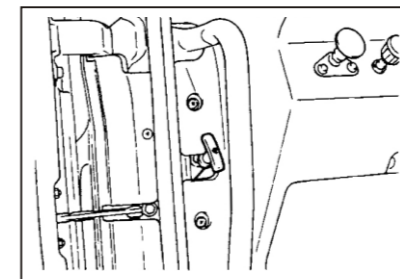

Pull the release knob to open the hood. The hood will spring up slightly. In front of the vehicle, lift the hood. The hood will open completely

by itself after it raised about halfway. To close the hood, lower and press on it. After closing the hood, try pulling it up to make sure it is closed.

**CAUTION:**

The hood should be keep closed when the car is in motion.

#### DIGITAL CLOCK(OPTIONAL)

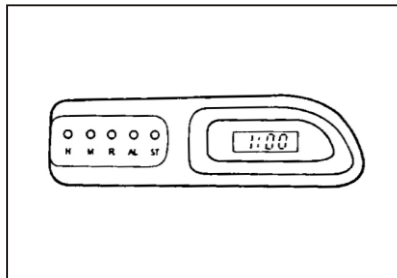

There are five control buttons for the digital clock. Their functions are:

H–Push "H" to adjust the hour indicated.

M–Push "M" to adjust the minute indicated.

R–Push "R" to reset minutes to ":00" to facilitate resetting the clock to the correct time. When this is done:

Pressing "R" between 10:30 and

11:29 changes the readout to 11:00.

Pressing "R" between 11:30 and 12:29 changes the readout to 12:00.

AL–Set the alarm button, press "AL", then "H" or "M".

ST–To stop the alarm, push the "ST" button.

#### CENTER CONSOLE

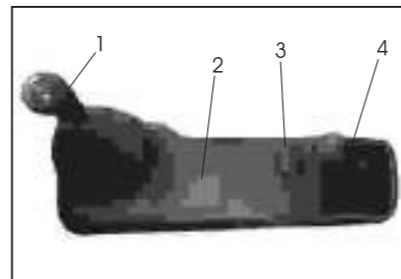

##### 1. Gearbox handle

The select lever is marked on the gearbox handle so that the driver can control the speed of the truck conveniently. Be sure to the select lever position right before shift the gear shift lever, else will lead to a wrong operation and the truck can't run steadily.

##### 2. Ashtray

The ashtray may be opened by pushing and releasing the ashtray door at its top edge. To remove the ashtray in order to clean it, the metal ash receptacle should be removed from the ashtray door. Do not attempt to remove the entire ashtray door assembly or will result in damages. Instead, push the metal ash receptacle down and forward in the ashtray door, and it can then be lifted out. To reinstall it, place it in the proper position and press it down and forward to re-engage the ash receptacle rear lip in the ashtray door. The ashtray lamp will only illuminate when the exterior body lights are switched on.

##### 3. Parking brake handle

When parking the vehicle, pull up the parking brake handle then the parking brake will be active. Push down the handle, the parking brake will be released and can continue to drive.

##### 4. Console

#### NOTE:

Pressure of the electrical source at the bottom of the assistant driver's dashboard is 24 V.

#### OVERHEAD CONSOLE

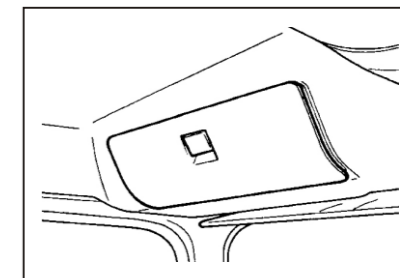

The overhead console is located in the interior ceiling.

### SUN VISOR

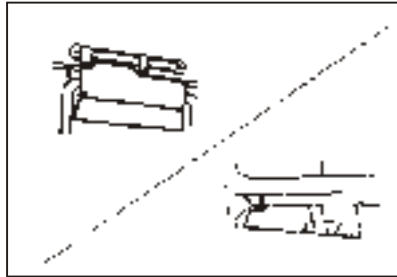

**CAUTION:**

Do not pull down the sun visors when the roadway, traffic or the visibility is not clear.

Your JAC is equipped with two sun visors to give the driver and passenger either frontal or sideward shade. The sun visors are fitted on both sides on standard models. To reduce glare or to shut out direct rays of the sun, turn the sun visors down to block the annoyance.

Some vehicles are equipped with the front and side sun visor for the driver, and the front sun visor for the passenger.

### AIR SPRAY NOZZLE

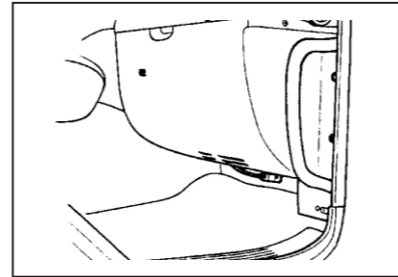

Separate the spray nozzle plug under the dash panel of passenger side and connect the air hose with this plug. Then you can clear your vehicle with air spray.

### STEREO SOUND SYSTEM MP3 radio panel map

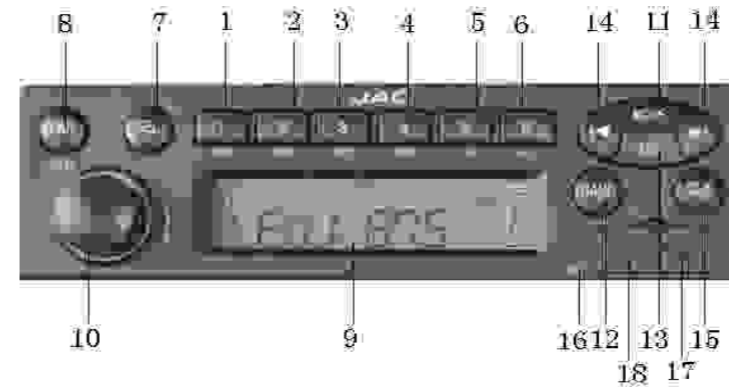

- 7. SEL.....Sound selection, acoustics settings  
PWR.....Short press: power on; Long press: power off.
- 8. MUTE.....Short press: mute on/mute off
- 9.....Monitor
- 10.....Volume knob: switch to adjust the sound volume
- 11. MODE.....Short press: choose source RAD 10-USB-AUX

- 12. BAND.....Choose wave band: short press- FM-MW-FM
- 13. AST.....Short press: radio browsing  
Long press: store radio station
- 14. ◀▶.....Radio mode  
Short press: auto search the radio stations up/down  
Long press: manual search the radio stations up/down

- 1. #1 button.....Preset key 1  
▶▶\*.....USB pause playback
  - 2. #2 button.....Preset key 2  
RND\*.....USB random play
  - 3. #3 button.....Preset key 3  
RPT\*.....USB repeat play
  - 4. #4 button.....Preset key 4  
SCN\*.....USB browsing play
  - 5. #5 button.....Preset key 5  
-10\*.....Play 10 songs back in USB state
  - 6. #6 button.....Preset key 6  
+10\*.....Play 10 songs ahead in USB state
  - USB playback mode  
Short press: last music/next music  
Long press: rewind/fast forward
  - 15. CLK.....Time setting/display button
  - 16. RST.....Reset switch
  - 17.....USB electrical connection
  - 18. AUX.....Insertion to AUX IN
- Tip: “\*” is the composite function in USB state.

#### Play

● When a flash disk is connected, the display will show USB and play the music in it automatically.

1.Next or previous song

● Press **◀** or **▶** to choose the song wanted.

2.Speed up or fast reverse (**⏮** or **⏭**)

● Long press **⏮** or **⏭** to fast reverse or speed up the current song, release to play normally.

3.Pause/play

● Pause the current song in flash disk.

● Short press #1 button to pause or play the current song in USB state.

4.Random play

● Random play all songs in flash disk.

● Short press #2 button to play/stop play randomly.

5.Play repeatedly

● Play the current song repeatedly.

● Short press #3 button to play/ stop play repeatedly in USB state.

6.Preview all songs

● You can preview all songs for 10 seconds.

● Short press #4 button to begin/stop preview songs.

7.-10 play

● Short press #5 button to play the 10th song backward in USB status.

8.+10 play

● Short press #6 button to play the 10th song forward in USB status.

#### Radio

1.Wave band

● Short press BAND/AST to choose the wanted waveband.

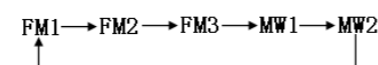

2.Auto search

● Press **◀** or **▶** to auto search radio channel.

● Press **◀** or **▶** to listen to the lowest frequency channel and press the **▶** to play the highest frequency channel.

3.Manual search (if you know the frequency of the radio channel)

● Press and hold the search button, the frequency will increase or decrease the frequency. Release the button and press continuously it in 2

seconds to increase/decrease 0.1MHz in FM status or 9KHz in MW status. If the button is not pressed within 2 seconds, the manual search will stop.

4.Save the channel manually

● Save the channel into the preset button(1-6). It can save 6 channels for each band.

● Move the wanted channel and press the preset button(1-6) for two seconds to save this channel.

5.Save the channel automatically

● Short press AST button to view all channels.

● Long press AST button to save the 6 strongest channels to 1-6.

● Change to FM1,FM2,FM3 mode,

long press auto search and save the 6 strongest channels into 1-6.

● Change to MW1, MW2 mode and long press AST button to auto search and save the 6 strongest channels to 1-6.

#### AUX IN mode play

Short press MODE button to enter AUX IN mode(AU on display), plug into the out music source and adjust the volume by the knob.

#### Explanations of audio

##### volume

● Turn the knob clockwise to increase the volume and anti-clock wise to decrease it. Please keep the volume not preventing you hearing the traffic information ( horn and alarm).

##### Sound effects settings

● Short press SEL to choose your favored effect

- BAS: bass

- TRE: treble

- BAL: balance

– FAD: back and forward

- Then choose the model you wanted by turning the volume knob, 5 seconds later the display will return to the last mode.

NOTE:

- Please keep the volume not preventing you hearing the traffic information ( horn and alarm)
- The working volt is 12V/24V and the negative pole of battery has grounded circuit(connected with the chassis). The radio may not work or be damaged if not following this.

- Please do not connect the loudspeaker line to the ground directly or with mega base equipment or power amplifier. Do not connect with the external loudspeaker devices as well.

- Please make sure all wire lines are installed well and not be worn by the sharpen edge or sliding components.

WARNING:

Please cut off the negative pole before settling up the radio in case of short circuit.

Remarks:

1. This music player can play MP3 file and WMA file.
2. Short press means to press for 0.5 second and long press means to press for 2 seconds.
3. If the player crashes caused by damaging music file or other problems and all buttons fail to work, it can be reset by pressing RST button to recover default settings.

Time setup

- Press CLOCK to show time in non-time showing mode.
- Long press CLOCK button for 3 seconds to enter setup mode.
- Press ◀ or ▶ to adjust the time.

Technical index  
FM

Tuning range .....87.5~108MHz

Sensitivity ..... 20dB

Degree of stereoscopic separation..... 25 dB

AM

Tuning range..... 522~1620KHz

Sensitivity..... 30dB

Audio

Power source .....12~16V ( 12V for machine use ) /22~24V ( 24V for machine use ) ( DC ) negative pole grounded

Impedance of the loudspeaker ..... 4Ω

Dimension.....178mm ( width ) ×150mm ( depth ) ×50mm ( height )

Total output power ..... 2×6.5 Watt

Frequency response ..... 100~10000Hz

Breakdown solutions

When you think that some functions fail to work, you can read and follow the instructions in the manuals carefully to check and solve the problems before send it to repair.

Common breakdowns and solutions

Phenomenon	Possible reasons and solutions
<b>Common conditions</b>	
The player does not work or display	<ul style="list-style-type: none"> <li>• Check the fuse and connector of the player with the vehicle</li> </ul>
The player works but no sound or very little sound	<ul style="list-style-type: none"> <li>• Increase the volume</li> <li>• Check the antenna and connector</li> </ul>
<b>Radio</b>	
Bad reception of radio	<ul style="list-style-type: none"> <li>• Check the antenna connected or not</li> <li>• Check the antenna spread or not</li> </ul>
Can not find any channels during auto searching	<ul style="list-style-type: none"> <li>• The signal is too weak</li> <li>• Search the channel manually</li> <li>• Check the antenna spread or not</li> </ul>
<b>Play</b>	
Longtime display but not read	<ul style="list-style-type: none"> <li>• Check the flash disk damaged or not</li> <li>• Check the flash disk connected well or not</li> </ul>
Sound distortion in USB mode	<ul style="list-style-type: none"> <li>• Check the flash disk damaged or not</li> </ul>
Cannot be played in USB mode	<ul style="list-style-type: none"> <li>• The player supports MP3 format and WMA format, check the format is right or not</li> <li>• Check the file damaged or not</li> </ul>
<b>AUX IN</b>	
Display AUX IN but no sound out	<ul style="list-style-type: none"> <li>• Check the output sound valid or not</li> <li>• Check the connector of AUX IN connected well or not</li> </ul>
Sound distortion	<ul style="list-style-type: none"> <li>• Check the connector of AUX IN connected well or not</li> </ul>

Please send the player to get repaired and not dismantle it by yourself if the problem still exists.

CD Panel map

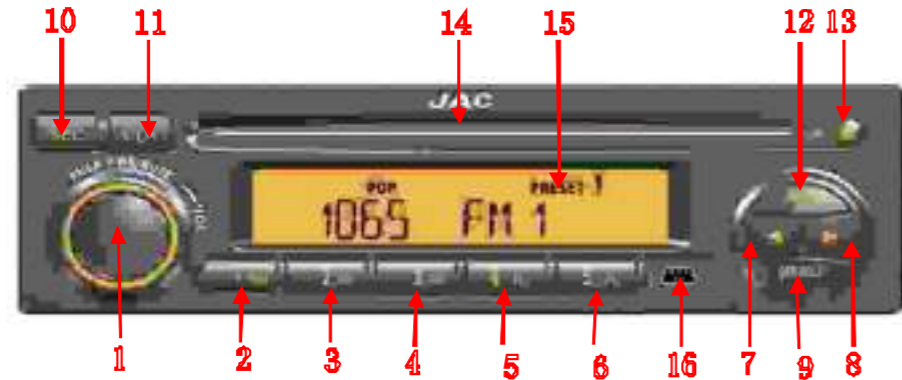

panel explanations

1. Knob.....When power off: short press to power on  
 When power on: short press to mute  
 When power on: turn around it to increase or decrease the volume  
 When power on: long press to power off
- 2.#1 button.....Save or turn to channel 1
- RND\*.....On/off of random play for CD/USB

3. #2 button.....Save or turn to channel 2
- RPT\*.....On/off of repeat play for CD/USB
4. #3 button.....Save or turn to channel 3
- SCN\*.....On/off of browsing play for CD/USB
5. #4 button.....Save or turn to channel 4
- 10\*.....Play 10 songs back for CD/USB
6. #5 button.....Save or turn to channel 5
- +10\*.....Play 10 songs ahead for CD/USB
7. ◀ .....Radio mode  
 Short press: auto searching to low frequency  
 Long press: manual searching to low frequency  
 CD/USB mode  
 Short press: previous song  
 Long press: fast reverse
8. ▶ .....Radio mode  
 Short press: auto searching to high frequency  
 Long press: manual searching to high frequency  
 CD/USB mode

- Short press: next song  
 Long press: speed up
9. SOURCE.....CD short press: choose CD → USB →  
 →radio→ CD circularly
- 10.SEL.....Sound effects choosing button
- 11.CLK.....To show clock
- 12.BAND.....Short press: choose waveband  
 AST.....Long press: automatically save
13. ▲ .....Push out the disk
- 14.disk port .....Diskport
- 15.LCD screen .....Display button functions
- 16.USB port.....USB port
- Remarks: " \* "means composite functions in CD/USB mode



#### CD/USB play

##### 1.Next or previous song(◀ or ▶)

- Press◀or▶ to choose the song wanted.

##### 2.Speed up or fast reverse (◀ or ▶)

- Long press◀ or ▶to fast reverse or speed up the current song, release to play normally.

##### 3.Random play

- Short press RND to play songs randomly in CD/USB mode.

##### 4.Play repeatedly

- Play the current song repeatedly
- Short press RPT button to play/stop play repeatedly in CD/USB state

##### 5.Preview all songs

- You can preview all songs for 10 seconds

- Short press SCN button to begin/stop preview songs

##### 6.–10 play

- This function allows you to play the 10th song backward.

- Short press –10 button to play the 10th song backward in USB status

##### 7.+10 play

- This function allows you to play the 10th song forward.

- Short press +10 button to play the 10th song forward in CD/USB status

##### 8.Exit the disk(in CD mode)

- Press ▲ to exit the CD

##### 9.Plug flash disk(in USB mode)

- Plug the flash disk to play the songs inside

#### Radio

##### 1.Wave band

- Short press BAND/AST to choose the wanted waveband.



##### 2.Auto search

- Press◀ or ▶to auto search radio channel

- Press ◀ to ▶ listen to the lower frequency channel and press the▶to play the higher frequency channel. Press the same button to search another channel.

##### 3.Manual search (if you know the frequency of the radio channel)

- Press and hold the search button, the frequency will increase or

decrease. Release the button and press it continuously in 2 seconds to increase/decrease 0.1MHz in FM status or 9KHz in MW status. If the button is not pressed within 2 seconds, the manual search will stop.

##### 4.Save the channel manually

- Save the channel into the preset button(1–5). It can save 5 channels for each band.

- Change to the target channel.

- Press the preset button (1–5) for two seconds to save this channel.

##### 5.Save the channel automatically

- Save the 5 strongest channels to 1–5.

- Change to FM1,FM2,FM3 mode, long press AST button for at least 2 seconds to search automatically and

save the 5 strongest channels into 1–5.

- Change to MW1, MW2 mode and long press AST button for at least 2 seconds to auto search and save the 5 strongest channels to 1–5.

#### Explanations of audio volume

- Turn the knob clockwise to increase the volume and anti-clockwise to decrease it. Please keep the volume not preventing you hearing the traffic information ( horn and alarm).

#### Sound effects settings

- Short press SEL to choose your favored effect

–BASS : bass

–TREBLE : treble

–BAL : balance

–FADER : back and forward

–CUSTOM : customized

- Adjust the volume to set up sound effects in CUSTOM mode.

–JAZZ : jazz

–VOCAL : vocal

–POP : pop

–ROCK : rock

–CLASSIC : classic

–FLAT : flat

- Then choose the model you wanted by turning the volume knob, 5 seconds later the display will return to the last mode. Only in BASS TRE mode, the bass or treble can be adjusted.



NOTE:

- Please keep the volume not preventing you hearing the traffic information ( horn and alarm).
- The working volt is 12V/24V and the negative pole of battery has grounded circuit(connected with the chassis). The radio may not work or be damaged if not following this.
- Please do not connect the loudspeaker line to the ground directly or with mega base equipment or power amplifier. Do not connect with the external loudspeaker devices

as well.

- Press exit button to exit the disk when it cannot be read for a transparent edge disk.
- Remove the while gasket before putting it into the player in case of reading failure. The player can only read 12mm disks.

WARNING:

Please cut off the negative pole before settling up the radio in case of short circuit.

Breakdown solutions

When you think that some functions fail to work, you can read and follow the instructions in the manuals carefully to check and solve the problems before send it to repair.

Common breakdowns and solutions

Phenomenon	Possible reasons and solutions
<b>Common conditions</b>	
The player does not work or display	<ul style="list-style-type: none"> <li>● Check the fuse and connector of the player with the vehicle</li> </ul>
The player works but no sound or very little sound	<ul style="list-style-type: none"> <li>● Increase the volume</li> <li>● Check the antenna and connector</li> <li>● Check the balance settlement of front and back, left and right</li> </ul>
<b>Radio</b>	
Bad reception of radio	<ul style="list-style-type: none"> <li>● Check the antenna connected or not</li> <li>● Check the antenna spread or not</li> </ul>
<b>CD</b>	
“ERROR” display ERROR on screen	<ul style="list-style-type: none"> <li>● Check the disk is put rightly</li> <li>● Check the disk is damaged or gets dirty.</li> </ul>
CD fail to play	<ul style="list-style-type: none"> <li>● The laser head be condensed with steam. Turn the player into radio mode for about 5 minutes to evaporate the steam.</li> </ul>
Screen shows “NO CD”	<ul style="list-style-type: none"> <li>● Check the CD is put into the player or not</li> </ul>
<b>USB</b>	
Longtime display but not read	<ul style="list-style-type: none"> <li>● Check the flash disk connected well or not</li> <li>● Check whether there are songs in the flash disk</li> </ul>
Fail to play in USB mode	<ul style="list-style-type: none"> <li>● The player supports MP3 format and WMA format, check the format is right or not</li> </ul>

Please send the player to get repaired and not dismantle it by yourself if the problem still exists.

HEATING AND VENTILATION  
(KNOB TYPE)

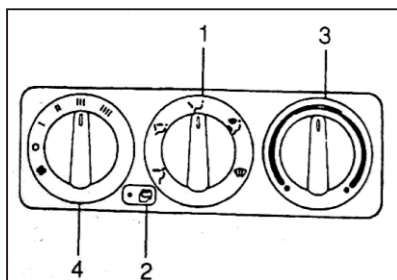

The heating and ventilation system has 4 control switches:

1. Air flow control
2. Air intake control
3. Temperature control
4. Fan speed control

Air flow control

The switch is used to guide the flow direction of the supplier air. Air can be supplied to the floor, instrument panel air outlet or windshield air outlet. Five symbols can be used to show different air supply positions: Face, Bi-Level, Floor, Floor-Defrost, and Defrost.

Face

"Face" Mode: Air will be supplied through the air outlet at the face height.

Bi-Level

"Bi-Level" Mode: Air will be supplied through the face air outlet and floor air outlet; cool air will be supplied through the instrument panel air outlet and warm air will be supplied through the floor air outlet.

Floor

"Floor" Mode: Air will be supplied through the floor air outlet.

Floor-Defrost

"Floor-Defrost" Mode: Air will be supplied through the windshield defroster air outlet and floor air outlet.

Defrost

"Defrost" Mode: Air will be supplied through the windshield defroster air outlet.

Air intake control

The switch is used to select the exterior fresh air or interior recirculation air.

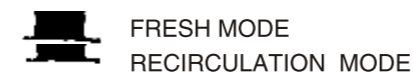

When pressing down the control key, the air intake modes (Fresh or Recirculation) can be changed.

FRESH MODE ( ): When the air intake control switch is turned to the Fresh Mode, the indicator lamp on the key will be off.

RECIRCULATION MODE ( ): When the air intake control switch is turned to the Recirculation Mode, the indicator lamp on the key will be on.

When selecting the "Fresh" Mode, exterior air will be drawn in for

heating or cooling based on other functions selected.

When selecting the "Recirculation" Mode, the heating system will draw in the interior air for heating or cooling based on other functions selected.

Temperature control key

The control key is used for warm air on/off and selecting the target temperature.

Fan speed control key  
(Air blower control)

The key is used for fan on/off and selecting the fan speed.

The air blower fan speed can determine the air supply capacity, which can be manually set between the first and fourth gears.

Heating control

1. During normal heating, please turn the air intake control switch to the "Fresh" gear and the air flow to the "Floor" gear;

2. To accelerate heating, please turn the air intake control switch to the "Rec" gear;

3. If the window gets frosty, please turn the air flow control switch to the "Def" gear and the air intake to the "Fresh" gear;

4. To get the maximum heating effect, please turn the temperature control switch to the "Warm" gear.

#### Bi-Level heating

The vehicle is equipped with the bi-level heating control switch. The warm air will be supplied through the floor air outlet and the cool air will be supplied through the dashboard air outlet. When the function is activated:

1. Turn the air flow control switch to the "Bi-Level" gear;
2. Turn the air intake control switch to the "Fresh" gear;
3. Turn the temperature control switch to the position between "Cool" and "Warm" gears;
4. Turn the fan speed to the target position.

#### Ventilation

The operation methods of the ventilation system are as follows:

1. To guide the air intake to the instrument panel air outlet completely, please turn the air flow switch to the "Face" gear;
2. Turn the air intake control to the "Fresh" gear;
3. Turn the temperature control to the position between "Cool" and "Warm" gears;
4. Turn the fan speed to the target gear.

#### A/C (OPTIONAL) A/C switch

Press down A/C switch key to turn on A/C.

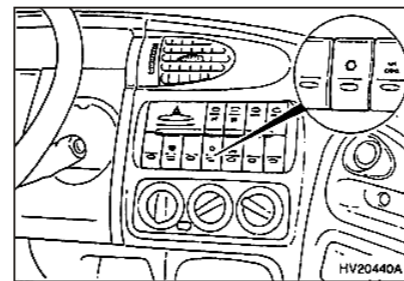

#### A/C OPERATION METHODS Refrigeration

Refrigeration methods with A/C:

1. Turn the side vent control switch to the "Off" gear to cut off all air

intake channels;

2. Turn on the fan control switch;
3. When pressing down the key and turning on A/C switch, A/C indicator lamp shall be on;
4. Turn the air intake control to the "Fresh" gear;
5. Turn the temperature control to the "Cool" gear (the gear is for the maximum refrigeration capacity; if turning the control button to the "Warm" gear, the refrigeration temperature can be turned up);
6. Turn the fan control switch to the target speed gear. To increase the refrigeration capacity, turn the fan control switch to the high gear or the air intake to the "Recirc" gear temporarily.

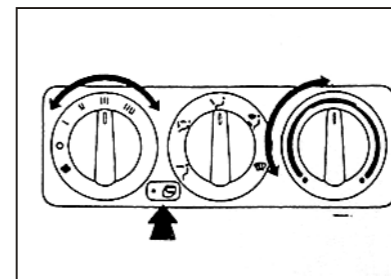

#### Dehumidification and heating

The operation methods for dehumidification and heating are as follows:

1. Turn on the fan control switch;
2. Turn on A/C switch and A/C indicator lamp shall be on;
3. Turn the air intake control to the "Fresh" gear;
4. Turn the air flow control to the

"Face" gear;

5. Turn the fan control switch to the target speed gear;
6. To increase the dehumidification effect, turn the fan to the high gear;
7. Adjust the temperature control to select the target temperature.

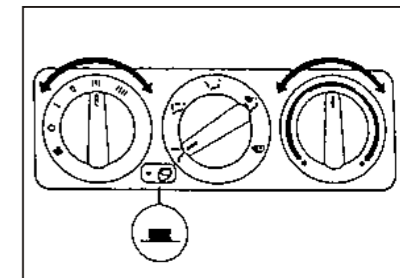

#### Service experience

1. When feeling the interior temperature is higher upon start,

open the window for several minutes for cooling;

2. When using A/C, please close all windows to avoid warm air entering;

3. In case of traffic jam and low speed, turn it to the low gear to increase the engine speed and A/C compressor speed;

4. During upslope, please turn off A/C to avoid engine overheating;

5. In winter or A/C out of service, please turn on and run A/C for several minutes every month.

It will help the lubricating oil circulation and keep A/C system be in an optimal running state.

Turn off A/C

In case of A/C out of service, turn the fan switch to the "Off" gear. When the vehicle is stopped, turn the air intake knob to the Recirculation Mode to avoid dust entering.

NOTE:

If turning on A/C under the Circulation Mode for a long time, the air will become dirty; you are recommended to change it to the Fresh Mode at short intervals;

Over refrigerating will be harmful to the health; it is recommended to set the interior temperature 5–6°C lower than the exterior temperature. ( People will feel some cool in the vehicle with such temperature)

## STARTING & OPERATING

#### BEFORE STARTING THE ENGINE

Before starting the engine, you should always:

1. Look around the vehicle to be sure there are no flat tires, puddles of oil or water or other indications of possible trouble.
2. After entering the car, make sure the parking brake is engaged.
3. Check your seat, seatback and headrest to be sure they are in their proper position.
4. Check the position of the interior and exterior mirrors.
5. Lock all the doors.
6. Fasten your safety belt and be sure that all other occupants have fastened theirs.
7. Turn off all lights and accessories

that are not needed.

8. When you turn the ignition switch to "ON", check that all appropriate warming lights are operated and that you have sufficient fuel.

#### IGNITION SWITCH

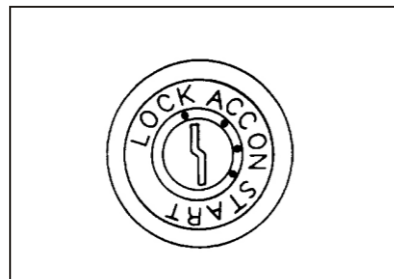

#### WARNING:

The engine should not be turned off or the key removed from the ignition key cylinder while the car is in motion.

#### "ON"

When the key is in the "ON" position, the ignition is on and all accessories may be turned on. If the engine is not running, the key should not be left in the "ON" position. This will discharge the battery and may also damage the ignition system.

#### "ACC"

With the key in the "ACC" position, the radio and other accessories may be operated.

#### "LOCK"

The key can be removed or inserted in this position. Steering is locked by removing the key.

#### NOTE:

You can remove the key by depressing the knob when the key is in "LOCK" position.

#### "START"

The position for engine start when released after starting the engine, the key will return automatically to the "ON" position.

#### NOTE:

Do not hold the key in the "START" position for more than 15 seconds.

#### TO START THE ENGINE

1. Place the shift lever in neutral and pull the parking brake lever all the way.
2. On vehicle with a cold start feature, set the "COLD START" switch to "ON" to reduce the warm up period of the engine in very cold weather. The "COLD START" pilot lamp will light.
3. Insert the key into the starter switch.
4. Depress the accelerator pedal all the way in and place the key to "START" position, and the starter will

turn and the engine will start.

The engine will be easier to start with the clutch disengaged.

#### CAUTION:

Points to note at starting

- Do not operate the starter for more than 15 seconds at a time. If the starter is operated for a longer period, the battery will run down or even heat damage to the starter will cause.

Do not jab the accelerator pedal but keep it depressed until the engine starts.

- Depress the clutch pedal when starting. Since the starter load is reduced, the engine will be easier to start, particularly in very cold weather.

5. On vehicles with a cold start feature, place the cold start switch to "OFF" after the engine speed has increased.

6. Slowly release the accelerator pedal and turn the fuel button in the direction of "H" to set the engine speed slightly higher than the idling speed. Allow the engine to warm up for over five minutes until the coolant temperature is rising.

Engine warming up is required for circulating oil throughout the engine and raising coolant temperature for proper combustion.

**CAUTION:**

Do not race the engine during the warm up period, as it could damage the engine.

7. During the warming up operation, check to ensure that the gauges and meters are performing properly.

8. After the engine warming up operation is over, turn the fuel button in the direction of "L" until the engine runs smoothly at idle speed.

**STARTING AND STOPPING THE ENGINE FOR TURBO CHARGER**

1. Do not race the engine or sudden accelerate the engine immediately after starting it. If the engine is cold, allow the engine to be idle for several seconds before it can be drove, to ensure sufficient lubrication of the turbo charger unit.

2. After high speed or extended driving, requiring a heavy engine load, the engine should be allowed to be idle, as shown in the chart below, before turning it off. This idle time will allow the turbo charger to cool prior to shutting the engine off.

Driving Condition		Required Idle Time
Normal driving		Not necessary
High speed driving	Up to 80 km/h	About 20 seconds
	Up to 100km/h	About 1 minute
Steep mountain slopes or continued driving in excess of 100km/h		About 2 minutes

**WARNING:**

Do not turn the engine off immediately after it has been subjected to a heavy load. Doing so may cause severe damage to the engine or turbo charger unit.

**SELECT LEVER**  
Manual transmission

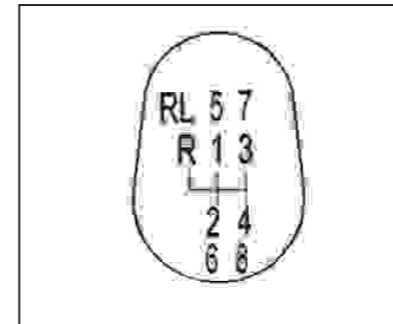

The transmission of the vehicle with the manual transmission is full synchromesh, which has 6 or 8 forward gears and 1 reverse gear. The transmission is controlled by the transmission control, with the long-distance flexible shaft control mode. The control lever is installed on the cab floor. This shift pattern is shown on the knob.

Before shifting the gear shift lever, fully depress the clutch pedal. Then release the pedal slowly. Make full use of the gear position.

**CAUTION:**

- Shift to the reverse position only when the vehicle is completely stopped.
- Do not rest your foot on the clutch while driving, because it will cause needless wear.
- Do not hold your vehicle with the engine when stopped on the upgrade. Use the parking brake.
- Upon gear selection and shifting, in addition to looking at the transmission control lever, you are also recommended to look straight ahead.
- In case of start, overload



upslope and driving on rough roads or barriers, please engage the first or second gear. However, during normal driving, it is not recommended to engage the first and second gears for a long time. During overload upslope, it is recommended to turn the gear shift lever to the low gear to avoid engine overload.

● During driving, it is not allowed to coast the vehicle with neutral gear, for it will damage the transmission input shaft; shorten the transmission service life, and affect the transmission control and normal driving.

Multi-gear transmission operation  
Gear shifting

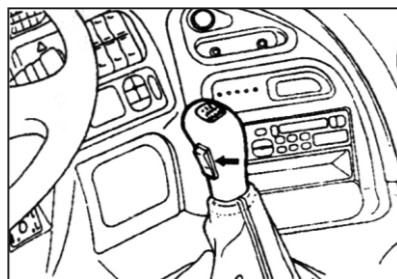



The gear shifting is the same as the common vehicle.

The transfer case can only be shifted between high and low gears.



For example: 4L→4H

1. Turn the auxiliary transmission gear switch to "H" or "L".
2. Loosen the acceleration pedal and step down the clutch pedal, the

automatic gear shifting will be turned to high or low gear. Check if  or  marker lamp is on.

**SIMULTANEOUS GEAR SHIFTING OF THE TRANSMISSION AND TRANSFER CASE**  
Simultaneous gear shifting of the switches

For example: 4L→5H or 4L←5H

1. Turn the auxiliary transmission gear switch to "H" or "L".
2. Loosen the acceleration pedal and step down the clutch pedal, the automatic gear shifting will  turned to high or low gear. Check if  or  marker lamp will be on in case of automatic gear shifting.
3. Operate the transmission control lever for gear shifting.

During gear shifting, please pay attention to followings:

1. Before stepping down the clutch, turn the auxiliary transmission gear switch to "L" from "H".
2. In case of turning to the low gear from the high gear, ensure that the engine speed is lower than 1,800rpm. Observe the tachometer to check the engine speed, and the engine will rotate at a higher speed after gear shifting.
3. Even though the auxiliary transmission gear switch is not operated properly, the gear shifting will not occur unless the clutch pedal is stepped down. If the shift lever is not operated properly, please reset it timely.

**DRIVING FOR ECONOMY**

Observe general operating manners and operate your vehicle on the "safety first" basis. To conserve fuel, prolong tire life and accomplish others for economical driving, follow these suggestions:

1. Avoid sharp turns, abrupt acceleration, quick start and abrupt braking except when unavoidable.
2. When accelerating, make an early shift.
3. Do not drive with the engine at an extremely high or low speed.
4. Observe proper coolant temperatures of 75 to 90(167 to 194 F) when driving. If coolant temperature is too low, it will not only increase fuel consumption but be harmful to the engine.
5. Maintain proper tire inflation pressure when driving.

**ANTI-LOCK BRAKE SYSTEM (OPTIONAL)**

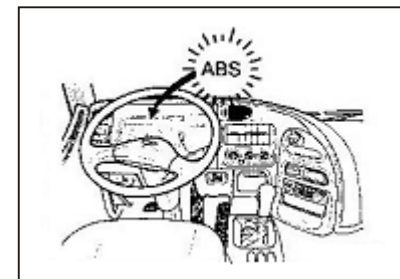

The Anti-Lock Brake System (ABS) is designed to prevent wheel lock-up during sudden braking or on hazardous road surfaces. The ABS control module monitors the wheel speed and controls the pressure applied to each brake. Thus, in emergency situations or on slick roads, your ABS will increase vehicle control during braking.

**NOTE:**

During ABS operation, a slight pulsation may be felt from the brake pedal when the brakes are applied. Also, a noise may be heard in the engine compartment while driving. These conditions are normal and indicate that the anti-lock brake system is functioning properly.

**WARNING:**

Your ABS will not prevent accidents due to improper or dangerous driving maneuvers. Even though vehicle control is improved during emergency braking, always maintain a safe distance between you and objects ahead. Vehicle speeds should always be reduced in extreme road conditions.

The braking distance for cars equipped with an anti-lock braking system may be longer than for those without it in the following road conditions.

- Driving on rough, gravel or snow-covered roads.

- Driving with tire chains installed.
- Driving on roads where the road surface is pitted or has different surface height.

During these conditions the vehicle should be driven at low speeds. The safety features of a vehicle equipped with ABS should not be tested in high speed driving or cornering condition. This could endanger the safety of yourself or others.

**GOOD BRAKING PRACTICES**

- After being parked, make sure the parking brake is not engaged and that the parking brake indicator light is out before driving way.
- Driving through deep water may get the brakes wet. They can also get wet when the vehicle is washed. Wet brakes can be dangerous! Your vehicle will not stop as quickly if the brakes are wet and it may also pull to one side. If you suspect that the brakes are wet, cautiously apply the brakes. Your brakes are probably wet if the braking action is not normal and requires either more pedal pressure than usual or pulls to one side. To dry the brakes, apply the brakes lightly until the

braking action returns to normal, taking care to keep the vehicle under control at all times. If the braking action does not return to normal, stop as soon as it is safe to do so and call the nearest service station for assistance.

- Don't coast down hills with the vehicle out of gear. This can be dangerous. Keep the vehicle in gear at all times, use the brakes to slow down, then shift to a lower gear so that engine braking will help you maintain a safe speed.

**NORMAL BRAKING**

To reduce the speed of the vehicle, first apply engine and exhaust brakes. After the vehicle has slowed down, depress the service brake pedal. When shifting down, use care to prevent engine overrunning.

Depress the brake pedal about 1/2 of the way at a point 25 to 35 m (28 to 38 yd) ahead of the target stopping point.

At a point 5 to 6 m (5.5 to 6.5 yd) ahead of the target stopping point, slowly release the pedal (about 1/2 to 1/3 of the initial stroke). After the vehicle has further approached the target point, slightly depress the pedal to bring the vehicle to a stop. In this manner the vehicle can be gently stopped without shock.



Pay attention to the following points:

- Since the service brakes provide powerful braking, there is no need for depressing the brake pedal all the way except in an emergency.
- If the vehicle is stopped with the initial foot pressure on the brake pedal, shock will be produced when the vehicle stops. Slowly ease foot pressure to minimize the shock. If the brake pedal is fully released, however, all the air in the brake system will be discharged and the vehicle may not stop at the target point but may move further ahead.
- Do not pump the pedal frequently. Frequent pumping will result in temporary loss of the air and the vehicle will move on. In a congested traffic, there is the danger of bumping

into the rear end of another vehicle ahead. Try to stop the vehicle by depressing the pedal once.

- On air over hydraulic brake vehicles, if the buzzer sounds and "BRAKE" pilot lamp lights when the pedal is depressed, stop the vehicle immediately. It is the sign of fluid leaks or low brake performance due to excessive brake shoe clearance. Call the nearest service shop for inspection and repair.

The brake system is a completely dual system. Even if fluid leaks occur in one of the circuits, therefore, the vehicle can be stopped through use of the other circuit.

#### ABRUPT BRAKING

In the event of an emergency, depress the brake pedal all the way. The brakes are applied to all wheels and the vehicle stops abruptly. Be careful of strong shock produced when the vehicle stops.

#### WARNING:

Frequent use of abrupt braking will result in premature wear of the tires, brake drums, brake linings and other parts and will reduce the life of all parts. Avoid using abrupt braking except in an emergency. When the road surface is wet as in rainy weather or when there is ice on the road surface, abrupt braking can cause hazardous skidding.

#### TO COUPLE A TRAILER

After the trailer has been coupled, perform the following steps and check:

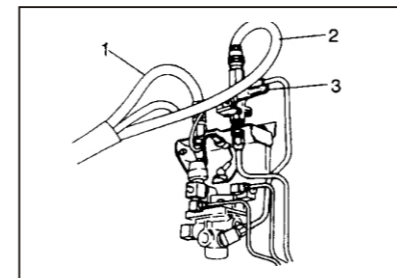

1. Couple the service 1 and emergency air hoses 2 and open air service valve 3.

#### NOTE:

Do not confuse the hoses when coupling them.

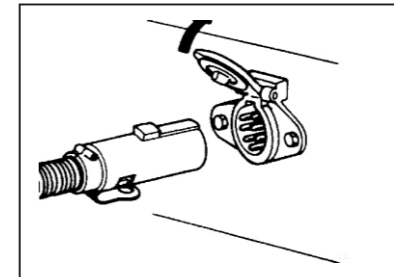

2. On a pintle hook equipped vehicle, pull out the cab control valve and shut off the supply of air to the trailer before connecting the service and emergency air hoses.

Connect the air hoses and open the air service valve. Then, push the cab control valve in and supply air to the trailer.

3. Connect the jumper cable.

Check to ensure that the stop lamps, tail lamps and turn signal lamps of the trailer light and flash by operating the respective switches.

4. Release the parking brakes of the trailer.
5. Pull the trailer brake lever toward you to check that the trailer brakes well.

If exhaust air sound is heard when the lever is returned, the brakes are performing well.

### BEFORE USING THE TRACTOR COUPLER

Before you use the tractor coupler, you should always:

- Apply grease to each nipple and operating part sufficiently.
- Whenever couple a trailer, apply grease to nipples of base upper part, rolling shaft and bracket sufficiently.
- After cleaning the used grease in containing to foreign matter, apply new grease sufficiently.

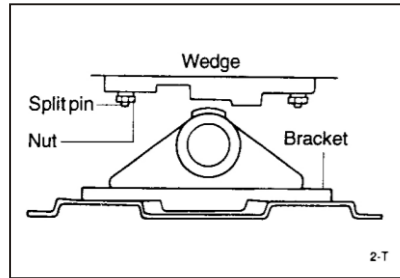

### HOW TO ADJUST ROLLING ANGLE

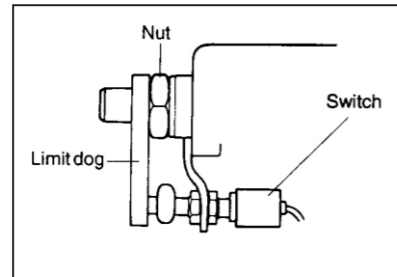

- Adjust the rotation angle according to the vehicle and driving conditions.
- Take down the split pin and clockwise rotate the nut 3-4 times for loosening.
- Install the traction disc in an ideal position.
- Screw down the nut and then insert the split pin and bend it.

### HOW TO ADJUST THE INTERNAL DIAMETER OF THE HOLDING PLATE

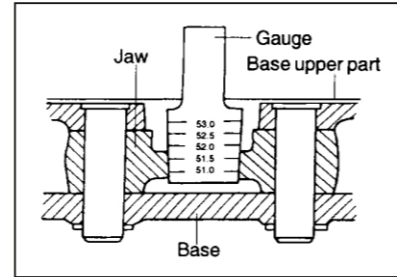

- If the inside diameter of jaw is worn, adjust it.
- Turn the limit dog with a tool clockwise.
- Loosen the nut slowly. This will diminish the inside diameter of jaw as moving yoke forward.
- If it's inside diameter is 51-51.2, use the Gauge to tighten the limit

dog to adhere the nut perfectly. At this time, check that the gauge could be rotated by hand.

- Before towing, make sure that there is no interference between coupler parts.
- Confirm the adherence state of limit dog and nut, operating state of secondary lock.
- Absolutely not tighten the nut clockwise harder than primary state.

### ADJUSTING BED

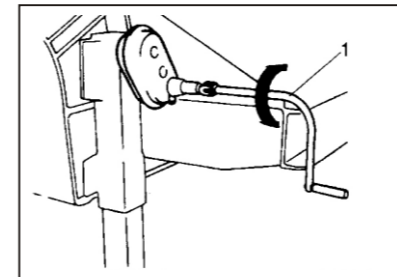

By rotating the lever 1, the height of the bed is controlled.

**CAUTION:**  
Be sure not to hurt yourself.

### AFTER ADJUSTING BED

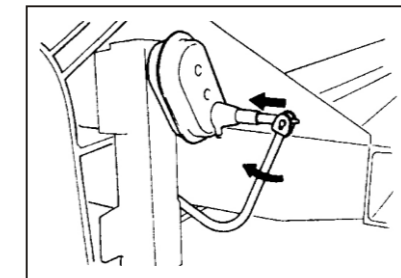

Do the adjusting as shown below before driving vehicle.

Trailer is braked and secured by chocks. Drawbar adjusted the coupling height.

**CAUTION:**  
Be sure no one is standing between tractor and trailer during the coupling operation.

### TRAILER LOCK SWITCH (OPTIONAL)

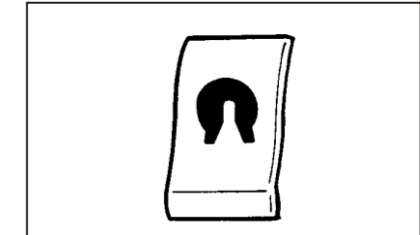

The trailer lock switch is located on the instrument panel. Use this switch to lock the turntable of the dolly when the vehicle is to reverse.

### TRAILER BRAKE LEVER

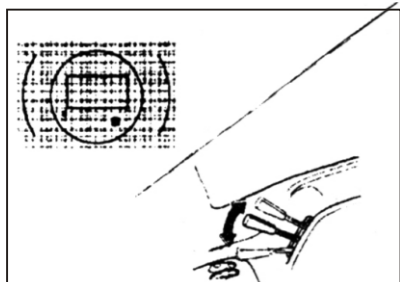

**CAUTION:**

Do not use the trailer brakes to slow down the vehicle. Avoid using the trailer brakes for lasting a long period.

When the lever is pulled toward you, trailer brakes will be applied. Use the brakes when going down a slope. The more the lever is pulled toward you, the stronger the braking power will be.

● Even when the trailer brakes are performing, the service brakes will normally apply.

### TILTING CAB

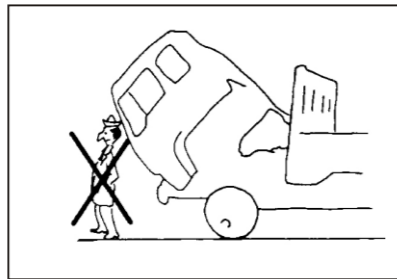

To tilt the cab, drive the vehicle to a flat surface and proceed as follows:

1. Apply the parking brake and shift the gearshift lever into neutral. Apply chocks to the wheels and shut off the engine.
2. If there are articles on the seat, they could break the windshield when the cab is tilted.
3. Make sure that the doors are securely closed.
4. Check to ensure that there is enough space around the cab. More than 1 m wide space is required before and above the cab.
5. Before the cab is brought down, check to ensure that there are no waste cloth and other combustible things left behind in the engine room.

### Manual tilting cab

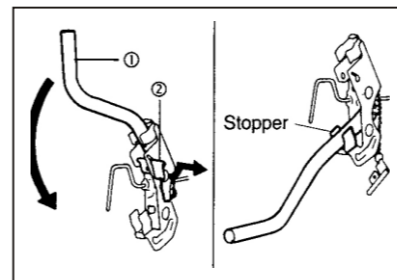

#### To raise the cab

1. Remove the hook lever key ② from the lever ①.
2. Pull the lever toward you.

**NOTE:**

Make sure that the lever is pulled all the way until it touches the stopper. If the lever is not pulled, the hook might not fit in place when the cab is returned.

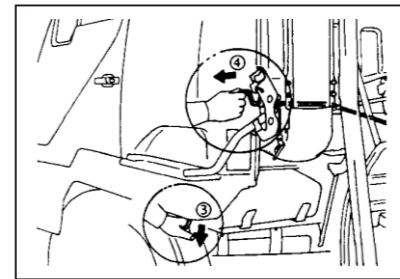

3. Hold the grip ③ of the cab. While pressing it down, pull the safety hook ④.
4. The cab will go up. While pressing it down to prevent abrupt motion, let it go up slowly.
5. Push the cab all the way up, and the cab will be automatically held in position by the cab stay. Insert the safety pin ⑤.

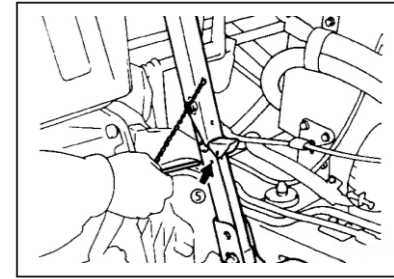

**CAUTION:**

For the sake of safety, make sure the safety pin is inserted.

#### PRECAUTIONS DURING OPERATION



We recommend the following points during operation.

- Check to ensure that the meters, pilot lamps and gauges are performing well.
- Release the parking brake lever all the way and confirm that the "PARKING BRAKE" pilot lamp has gone out.
- When making a start in loaded condition, shift into the first gear and

make slow start. Extended use of the clutch in half-engaged position will reduce the life of the clutch.

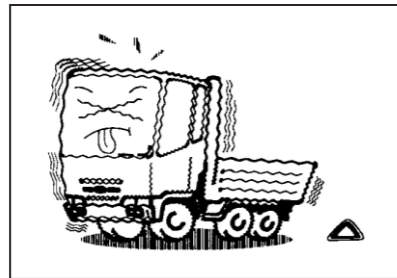

- If strange sound, vibration, unsmooth acceleration, odor or anything wrong is noted, stop the vehicle and check all conditions immediately.

If the causes cannot be found out or if the correction is impossible, have

the vehicle checked by the nearest service station.

- If hard steering or inadequate brake application occurs during operation, stop and check the vehicle immediately.

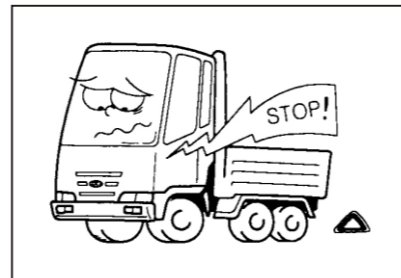

- If any pilot light or the sounds is abnormal, stop the vehicle immediately.

The red pilot lamps should be "OFF" during operation. If there is any red

#### OIL PRESSURE

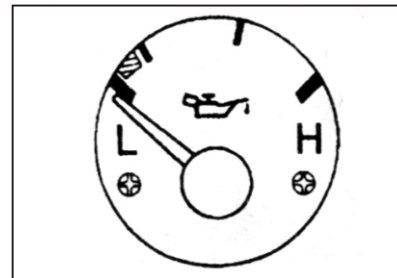

pilot lamp that is "ON", it shows that there is something wrong. Stop the vehicle and check the cause immediately.

- The orange and green pilot lamps will light when the respective switches are turned on. They do not indicate the trouble.

#### CAUTION:

Operation of the vehicle with a red pilot lamp "ON" can be dangerous. Be sure to stop the vehicle, find the cause and correct defective points promptly.

The buzzer will be silenced when the vehicle is stopped and the parking brake lever is pulled.

If the oil pressure falls below 100KPa while the engine is idling, the "OIL PRESSURE" pilot lamp will light and the buzzer will sound.

Stop the engine and check for oil leaks and level at once. If they are good, the oil system is defective. Have the oil system checked by an authorized service station.

The "OIL PRESSURE" pilot lamp also light when the oil filter is

clogged. Be sure to check the pressure gauge to confirm the oil pressure.

In severe cold weather the pilot lamp may continue to light for a while after starting because of increased oil viscosity. Do not operate the vehicle until the engine warms up fully.

#### ADDING COOLANT

- Use city water as coolant. Avoid the usage of hard water such as river water if possible.
- When the radiator cap is removed, place a cloth over the cap, raise the pressure release lever and slowly open the cap. If the cap is abruptly opened while the coolant is still hot, the hot water might gush out and

might cause scalding.

● If a large amount of cold water is abruptly poured in an overheated engine, cracks might develop in the crankcase, etc. Slowly add water, while keeping the engine running.

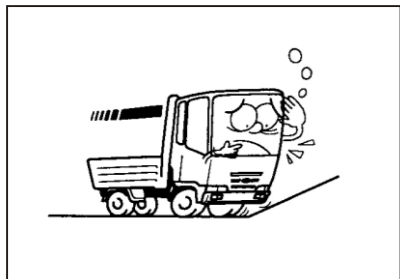

● Same ratio as the coolant in the radiator should be added.

#### PRIOR TO GOING DOWN A SLOPE

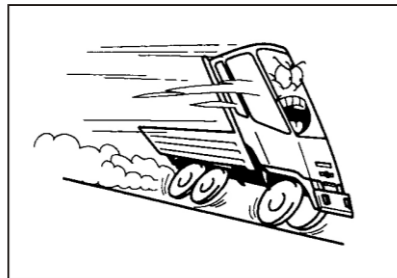

- Use engine brake and exhaust brake.
- Do not overuse the service brakes.
- Especially not increase the speed excessively.

Make sure that the engine is not overloaded.

● Make sure that the brakes can be applied properly.

#### ON TRACTOR

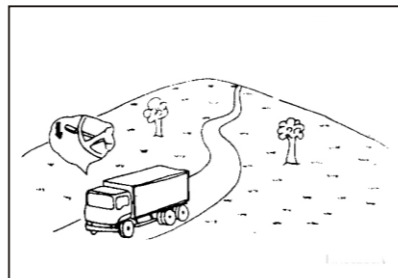

- Apply trailer brakes when going down a zigzag slope.
- Even when the trailer brakes are operative, the service brakes should be applied to both the tractor and trailer.

#### CAUTION:

Avoid extended use of the trailer brakes as far as possible.

#### INSTRUCTIONS FOR INTERAXLE DIFFERENTIAL (OPTIONAL)

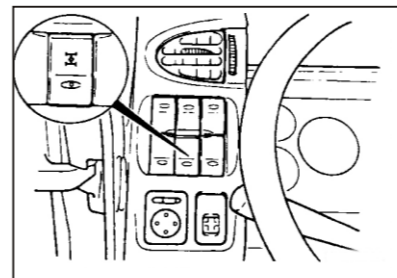

If there is a rough road ahead, temporarily stop the vehicle and lock the interaxle differential.

When the interaxle differential is locked, the "DIFFERENTIAL LOCK" pilot lamp will light.

If you went ahead without locking the interaxle differential and found it impossible to move ahead any

further, depress the brake pedal immediately. After the tires have stopped rotating, push the lock switch to lock the interaxle differential. After you have got out of the rough road, push the switch again to unlock the interaxle differential.

#### CAUTION:

Make sure that the tires are stationary when the interaxle differential lock switch is pushed.

#### EMERGENCY BRAKE (TRACTOR)

When the compressed air pressure abnormally drops down, the emergency brake will brake the rear wheels. Observe the following instructions.

#### How to operate

When the compressed air pressure falls below 2.7 kgf/cm<sup>2</sup> (265 kPa), the emergency brakes are automatically applied.

Manual emergency brake application can be accomplished by pulling the parking brake knob in. Use the knob in case of emergency.

How to release

When the compressed air pressure falls and the emergency brakes are manually applied, run the engine until the AIR pilot lamp goes out. Thereafter, push the parking brake knob to release the emergency brakes.

Since the pressure might fall temporarily after the release, check the pressure before starting the vehicle.

If Air pressure warning light is "ON" when the parking brake knob is pushed, it means the emergency brakes are not fully released, and will cause brake dragging. When the AIR pilot lamp is "ON", therefore, do not push the knob.

If the emergency brakes are automatically applied due to a defective brake line, the compressed air pressure can not rise so quickly.

Since the standby tank is used for emergency brake release, remember that the emergency brake release can be only twice.

When the air in the standby tank has been fully consumed, the pressure may not be enough. And special tools are required. Ask the help from your nearest service station.

## IN CASE OF EMERGENCY



#### IF THE ENGINE WILL NOT START

##### CAUTION:

If the engine will not start, do not push or pull the car to start it. This could result in a collision or cause other damages.

If engine doesn't turn over or turns over slowly :

1. Check the battery connections to be sure they are clean and tight.
2. Turn on the interior light. If the light dims or goes out when you operate the starter, the battery is discharged.
3. Do not push or pull the vehicle to start it. See instructions for "Jump Starting" on the following pages.

#### IF ENGINE TURNS OVER NORMALLY BUT DOES NOT START

1. Check fuel level.
2. Check injection pump nozzle.
3. If engine still refuses to start, call JAC service station or seek other qualified assistance.

#### JUMP STARTING

##### WARNING:

It should be very careful to operate the battery in case of injuries of people, battery explosion, electrolyte burning or damages to the electrical components by sparks.

To jump start a car with a discharged battery, follow this procedure exactly:

1. If the booster battery is installed in another vehicle, be sure the two vehicles are not touching.
2. Turn off all unnecessary lights and accessories in both vehicles.
3. Attach the clamps of the jumper cable in the order as described below. First, attach one clamp of the jumper cable to the positive (+) post or cable of the discharged battery. Then attach the other end of the same cable to the positive (+) post or cable of the booster battery. Next, using the other cable, attach one clamp to the negative (-) post or cable of the booster battery. Then attach the other end of that cable to a solid metal part of the engine away

from the battery. Do not connect the cable to any moving part.

4. Start the engine in the car with the booster battery and let it run for a few minutes. This will help to assure that the booster battery is fully charged. During the jumping operation, run the engine in this vehicle at about 1000 rpm.
5. Start your engine using the normal starting procedure. After the engine starts, leave the jumper cables connected and let the engine run at idle speed or about 1000 rpm for several minutes.
6. Following the exact reverse order of their being attached, carefully remove the jumper cables. Remove the negative cable first, then the positive cable.

#### IF THE ENGINE OVERHEATS



If your temperature gauge indicates overheating, or hear loud pinging or knocking, you experience a loss of power. The engine is probably too hot. If this happens, you should:

1. Pull off the road and stop soon as it is safe to do so.
2. Place the gear selector lever in neutral and set the parking brake. If the air conditioner is on, turn it off.

3. If coolant is running out or steam is coming out from the cap, stop the engine. Do not open the cap until the coolant has stopped running or the steaming has stopped. If there is no visible loss of coolant and no steam, leave the engine running and check to be sure the engine cooling fan is operating. If the fan is not running, turn the engine off.

4. Check whether the water pump drive belt is loosing or not. If it is not loosing, check that it is tight. If the drive belt seems to be satisfactory, check for coolant leaking from the radiator, hoses or under the vehicle. (If the air conditioner is running, it is normal for cold water to be draining from it when you stop).



**WARNING:**

While the engine is running, keep hands, long hair and clothing away from moving parts such as the fan and drive belts to prevent injury.

5. If the water pump drive belt is broken or the coolant is leaking out, stop the engine immediately and call the nearest JAC service station for assistance.

**WARNING:**

Do not remove the radiator cap when the engine is hot. This may allow coolant to blow out of the opening and cause serious burns.

6. If you cannot find the cause of the overheating, wait until the engine temperature has returned to normal. Then, if coolant has been lost, carefully remove the radiator cap and add water to bring the fluid level in the reservoir up to the halfway mark.

7. Keep an eye on further signs of overheating during driving. If overheating happens again, call a JAC service station for assistance.

**SPARE TIRE**

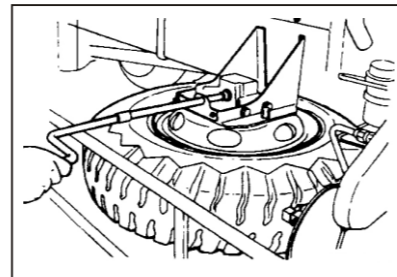

1. To install a tire, face the convex side of wheel upward, put the hanging plate in the disc wheel, and rotate the spare tire carrier handle clockwise to lift the tire.

**NOTE:**

While lifting the tire, check to ensure that the chain is not twisted and that the hanging plate is not displaced.

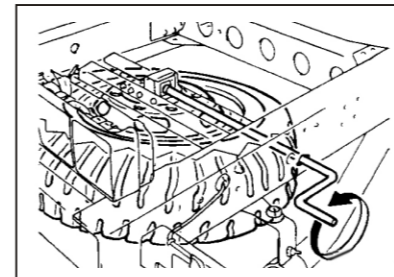

2. Check to ensure that the tire has been firmly secured.

**NOTE:**

The spare tire should also be inflated to specifications and should be checked for external damage and wear.

If the spare tire cannot be firmly secured, store the spare tire in the rear body or cab and have inspection at your nearest service station.

**CHANGING A FLAT TIRE**

If a tire goes flat while you are driving

- Take your foot off the accelerator pedal and let the car slow down while driving straight ahead. Do not apply the brakes immediately or attempt to pull off the road as this may cause a loss of control. Brake carefully and pull off the road, when the truck reaches a safe speed .

Drive off the road as far as possible and park on firm, level ground. If you are on a divided highway, do not park in the median area between the two traffic lanes.

- When the car is stopped, turn on your emergency hazard flashers, set the parking brake and engage the reverse gear.

● Change the tire following the instructions provided on the following pages.

When preparing to change a flat tire, check to be sure the gear selector lever is in reverse gear and that the parking brake is set, then:

1. Obtain spare tire and tool

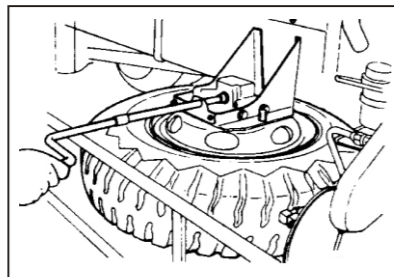
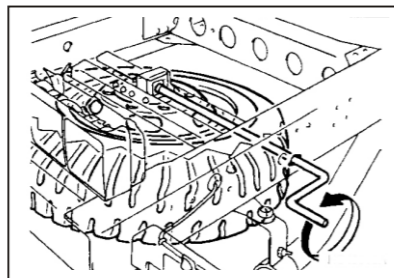

2. Block the wheel

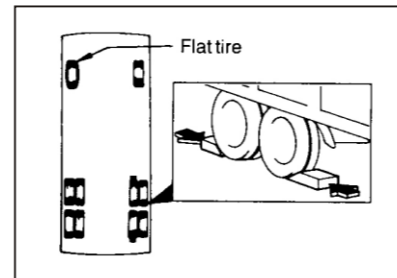

Block the wheels that is diagonally opposite from the flat to keep the vehicle from rolling when the truck is raised on the jack.

3. Loosen wheel nuts

The wheel nuts should be loosened slightly before raising the truck.

- 1) Tire
- 2) Wheel nut

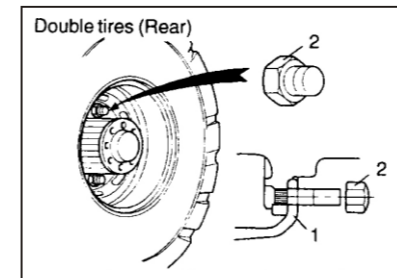

4. Changing wheels

Use the wrench to loosen the wheel nuts, then remove them with your fingers. Remove the wheel, slide the wheel off the studs and lay it down so it cannot roll way.

To re-installed the wheel, put the wheel on the hub and put the wheel nuts on the studs and tighten them with fingers.

CAUTION:

Make sure that the rear outer tires are raised on a jack when they have to be replaced. Do not attempt replacing the outer tire with the inner tire placed on a stone.

Be careful not to hurt yourself when changing a flat tire.

5. Lower vehicle and tighten nuts

To lower the car to the ground, turn the valve 1 counterclockwise by the jack handle.

Then position the wrench as shown in the drawing and tighten the wheel nuts.

WHEEL NUT TIGHTENING TORQUE

8 studs wheel: 485 to 545 Nm (49 to 56 kgm)

10 studs wheel: 603 to 749 Nm (61 to 76 kgm)

NOTE:

Maintain the wheel nuts interval.

● After driving your vehicle during first 1 · 000 km, retighten the wheel nuts with the specified torque.

● And then, wheel nuts should be checked or retightened for every 5 · 000 km or a month.

After replacing the tire, if you drive your vehicle for 50~100 km, then the wheel nut should be retightened.

#### TIRE INFLATION PRESSURES

Low tire inflation pressures could cause overheating and burst of the tire. High tire inflation pressures, on the other hand, will drastically reduce tire life.

When tires were replaced, be sure to adjust the tire inflation pressures to the standard values.

Precautions for adjustment of tire inflation pressures

1. Adjustment should be made while the tires are cold before operation.
2. In the case of double tires, make sure that there is no difference in inflation pressure between the tires. If there is a difference, the higher inflated tire will suffer premature wear and damage, and

the lower pressure one will also be adversely affected.

3. During operation or immediately after operation, the tire inflation pressures will increase because of the heat. Since the increase of tire inflation pressure during operation is normal, do not deflate the tires.

4. The tire inflation pressures will not increase during high speed operation.

When tires are replaced, pay attention to the following points:

1. New tires should be installed to the front wheels before they are moved to the rear wheels. During the initial period of use, adjust their inflation pressures.

The operation should be performed after running more than 200 km (124 miles) at 60 km/h (37 mph) or lower speed.

2. Use tires of the same brand, size and pattern. Avoid mixed use of different types of tires, as there is a danger of deterioration in handling and stability.

3. The difference in outside diameter between the inner and outer tires of the double tire should be limited to 12 mm (0.47 in.) or less.

#### The position of rear wheel

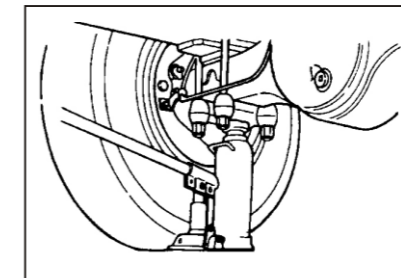

If there is a difference, install the small diameter tire inside.

4. Since snow tires are slightly different in size from general tires of the same size, avoid mixed use of a snow tire and general tire.

#### HOW TO USE THE JACK Put the jack in place

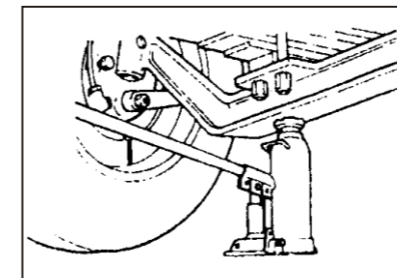

The base of the jack should be placed on firm, level ground. The jack should be positioned as shown in the drawing.

#### NOTE:

Do not place the jack under the rear wheel track.

#### HOW TO OPERATE THE JACK

To rise the jack

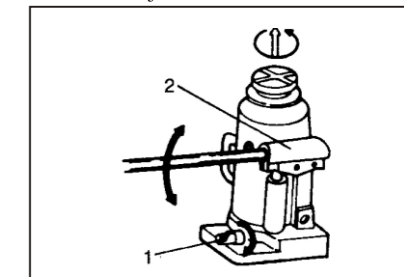

If the jack up-point is too low, extend the jack by turning the jack head counterclockwise. Close the valve 1 by turning it clockwise and then insert the wrench handle into the socket 2 and move it up and down.

To lower the jack

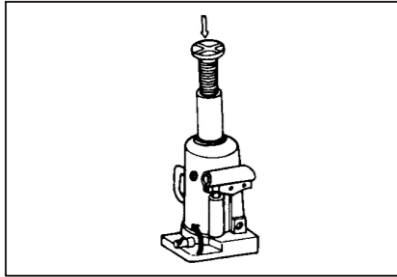

Turn the valve counterclockwise by the wrench handle.

**WARNING:**

- After using, push the jack all the way down and close the valve.
- Do not overload when raising the jack.
- Do not get under the truck when it is supported by the jack! The vehicle could fall and cause serious injury or even death. No one should stay in the truck while the jack is being used.

**TOWING**

When using the towing hook, observe the following:

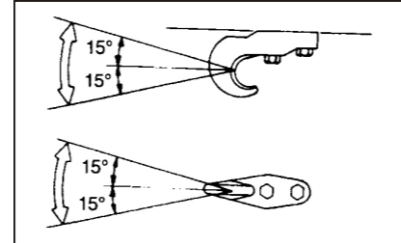

Make sure that the towing angle of hook does not exceed the limits shown in illustration. Make sure that no load is abruptly placed on the towing hook.

**NOTE:**

The angles specified in illustration should be kept strictly when your vehicle is towed by a vehicle of the same size.

When your vehicle is towed, pay attention to the following points:

- When your vehicle is towed, remove the rear axle shafts.
- When your engine or brakes are defective, make sure that your vehicle is towed by a towing vehicle designed for the purpose.
- The engine brake, exhaust brake and parking brakes (air over hydraulic brake vehicle) should not work when being towed.

**PRECAUTIONS BEFORE THE VEHICLE FAILS**

- If anything goes wrong during operation, calm yourself and gradually reduce the vehicle speed, while paying attention to the vehicles behind, stop the vehicle close to the shoulder of the road.
- Set the hazard warning switch to "ON" to make the hazard lamps flash. At the same time, place a red flag or a red lamp for indication of the trouble. If the indication of the trouble is not made, there is a danger of an approaching vehicle bumping into your vehicle.
- Be sure to apply chocks to the tires. If the propeller shaft or rear axle is defective, the parking brakes

might not be applied.

- Check the faulty point. If you can correct it yourself, proceed after making sure that neither your safety nor others' will be jeopardized.
- If you cannot correct the trouble yourself, contact the nearest service station.

## APPEARANCE CARE

### CORROSION PREVENTION & APPEARANCE CARE

By using the most advanced design and construction practices to combat corrosion, JAC produces trucks of the highest quality. However, this is only part of the job. To achieve the long-term corrosion resistance your JAC can achieve, the owners cooperation and assistance is also required.

#### COMMON CAUSES OF CORROSION

The most common causes of corrosion on your truck are:

- Road salt, dirt and moisture that is accumulated underneath the truck.
- Removal of paint or protective coatings by stones, gravel, abrasion or minor scrapes and dents which leave unprotected metal exposed to corrosion.

### HELP PREVENT CORROSION

You can help prevent corrosion from getting started by observing the following:

Keep your truck clean

The best way to prevent corrosion is to keep your truck clean and free of corrosive materials. Attention to the underside of the truck is particularly important.

● If you live in a high-corrosion area near the ocean, or with road salts, industrial pollution, acid rain, etc. You should take further care to prevent corrosion. In winter, clean the hose under your car at least once a month and be sure to clean the underside thoroughly when winter is over.

● When cleaning the truck underneath, pay attention to the fenders and other areas that are hidden.

● Do a thorough job; just dampening the accumulated mud rather than washing it away will accelerate corrosion rather than preventing it. High pressure water is particularly effective in removing accumulated mud and corrosive materials.

● When cleaning the cab instrumentation and frame, be sure that draft holes are kept open so that moisture can escape and not be trapped inside to accelerate corrosion.

## APPEARANCE CARE

In order to maintain the value of your vehicle, it is necessary to perform regular maintenance in the proper procedure. Make sure your vehicle can work in any normal environmental. Carefully select the materials used for washing. Make sure that they do not contain corrosives. If any question, contact an authorized JAC service station for assistance in the material selection.

### Washing

Chemicals contained in the dirt and dust picked up from the road surface can damage the paint coat and body of your vehicle if left in prolonged contact.

Frequent washing is the best way to

protect your vehicle from this damage. This will also be effective in protecting it from environmental elements such as rain, snow, salt and moisture air, etc. Do not wash the vehicle in the sunlight. Park the vehicle in the shade and spray it with water to remove dust. Next, use plenty of clean water and a vehicle washing brush or sponge, to wash the vehicle from top to bottom. Use a mild vehicle washing soap if necessary. Rinse thoroughly and wipe with a soft dry cloth. After washing the vehicle (including washing in an automatic vehicle wash), carefully clean the joints and flanges of the doors, etc. where dirt is likely to remain. Clean the engine room and the bottom of chassis with

steam cleaner. Be careful, not blow steam into electrical devices such as starter, generator, etc.



### Waxing

Waxing the vehicle will help prevent the adherence of dust and road chemicals to the paintwork. Apply a wax solution after washing the vehicle, and apply wax at least once every three months.

### Polishing

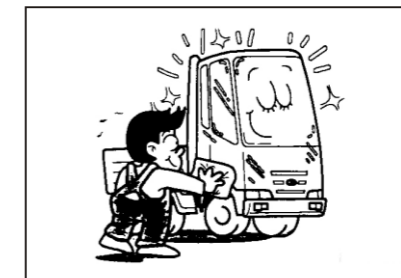

The vehicles should only be polished if the paintwork has become stained or lost its luster. Mat-finish parts and plastic bumpers must not be

### CAUTION:

When washing your vehicle, pay attention to the following points:

- Be sure to stop the engine beforehand.
- Cover the starter, generator and other electrical devices to prevent exposure to steam or water.
- Do not spray water against the air cleaner inlet and its vicinity.

polished. Polishing these parts will stain or damage them.

### Spot cleaning

Don't use gasoline, strong solvents or corrosive cleaning agents. These can damage the truck. To remove road tar, use turpentine on a clean, soft cloth. Remove dead insects or tree sap, with warm water or mild soap water. Soak the spot and rub gently. If the paint has lost its luster, use a commercial car-cleaning polish.



#### CLEANING THE INTERIOR

Clean the vinyl upholstery

To clean the vinyl upholstery, first remove loose dirt and dust with a vacuum cleaner. Then apply mild soap water or cleaning solution to a clean sponge or soft cloth. Cover the surface to loosen the dirt, then wipe them away. If dirt stains are not removed, repeat this procedure until it is clean. Do not use gasoline, solvent, paint thinner or other strong cleaners.

Cleaning the carpets

Use a foam-type carpet cleaner. Cleaners of this type are filled in aerosol cans in liquid or powder form. Read the instructions and follow them exactly. Using a vacuum cleaner with the appropriate

attachment, remove dirt from the carpets as much as possible. Apply the foam following the manufacturer's directions, then rub in overlapping circles. Do not add water. These cleaners work better when the carpet is drier.

Cleaning the safety belts

To clean the safety belts, use a cloth or sponge with mild soap water or cleaning solution with warm water. Do not use strong detergents, dye, bleach or abrasive materials on the safety belts as this may weaken the fabric.

While cleaning the belts, inspect them for fraying, cuts or other signs of damages and replace them if necessary.

Cleaning the windows

You may use any household window cleaner on the windows.

## VEHICLE MAINTENANCE REQUIREMENTS



#### ENGINE OIL AND FILTER

The engine oil and filter should be changed at specified intervals in the maintenance schedule. If the truck is being driven in severe conditions, more frequent oil and filter changes are required.

#### SCR SYSTEM

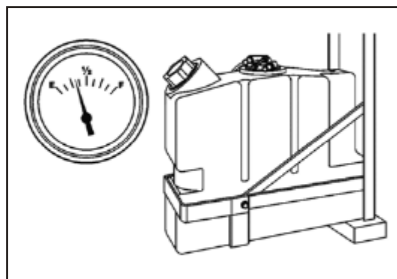

SCR means selective catalytic reduction, which takes 32.5% urea water solution (DEF) as the reducing agent and fills it into the tail gas flow.

In addition, DEF in the high temperature tail gas will be atomized into ammonia; under the effect of the catalytic reducing agent, ammonia will generate chemical reaction with nitric oxide (NOx) in the tail gas and produce innocent nitrogen and water.

Please check DEF level everyday; in case of insufficiency, please timely fill it.

#### CAUTION:

It is not allowed to fill following solution into DEF tank: Diesel, water and self-made urea water solution; or else, the metering pump will be seriously damaged and the engine power will be reduced.

#### VALVE CLEARANCES

An incorrect valve clearance will not only result in rough engine operation but will cause excessive noise and reduce engine output.

Inspect valve clearance and adjust as required while the engine is cold.

#### FUEL LINES AND CONNECTIONS

Check the fuel lines and connections for leakage and damages. Replace any damaged or leaking part immediately.

#### FUEL FILTER

A clogged filter can limit the speed at which the vehicle may be driven, damage the emission system and cause hard starting. If an excessive amount of foreign matter accumulates in the fuel tank, the

filter may require replacement more frequently.

After installing a new filter, run the engine for several minutes, and check for leaks at the connections.

#### VACUUM AND CRANKCASE VENTILATION HOSES

Inspect the surface of hoses for evidence of heat and/or physical damage. Hard and brittle rubber, cracking, tears, cuts, abrasions, and excessive swelling indicate deterioration. Particular attention should be paid to examining those hose surfaces nearest to high heat sources, such as the exhaust manifold.

Inspect the hose routing to assure that the hoses do not contact with

any heat source, sharp edges or moving component which might cause heat damage or mechanical wear. Inspect all hose connections, such as clamps and couplings, to make sure they are secure, and no leaks. Hoses should be replaced immediately if there is any evidence of deterioration or damages.

#### FUEL HOSE, VAPOR HOSE AND FUEL FILLER CAP

The fuel hose, vapor hose and fuel filler cap should be inspected regularly in the maintenance schedule. Make sure that a new fuel hose, vapor hose or fuel filler cap is correctly replaced. Consult your JAC dealer if you have any questions.

#### AIR CLEANER FILTER

The genuine JAC part is recommended for replacement of the air cleaner filter.

#### DRIVE BELTS

Inspect all drive belts (water pump and alternator) for evidence of cuts, cracks, excessive wear or oil stain, and replace if necessary. Drive belts should be checked periodically for proper tension and adjusted if necessary.

#### ENGINE COOLANT

The coolant should be changed at those intervals specified in the "Vehicle Maintenance Requirements" section.

#### BRAKE HOSES AND LINES

Visually check for proper installation, fraying, cracks, deterioration and any leakage. Replace any deteriorated or damaged parts immediately.

#### BRAKE FLUID

Check brake fluid level in the brake fluid reservoir. The level should be between "L" and "H" marks on the side of the reservoir. Use only hydraulic brake fluid conforming SAE J706

#### BRAKE DRUMS AND LININGS

Check for scoring, grinding line, leaking fluid, broken parts, and excessive wear.

#### BRAKE PADS, CALIPERS AND ROTORS

Check the pads and discs for excessive wear, and calipers for leaking fluid leakage.

#### PARKING BRAKE

Inspect the parking brake system such as parking brake lever, cables and so on.

#### EXHAUST PIPE CONNECTIONS, MUFFLER AND SUSPENSION BOLTS

Check the exhaust pipe, muffler, and suspension connections for looseness or damages.

#### STEERING GEAR BOX, LINKAGE AND BOOTS

With the truck stopped and engine off, check for excessive free-play of the steering wheel, check the linkage for bends or damages. Check the dust boots and ball joints for deterioration, cracks, or damages. Replace any damaged parts.

#### PAPER ELEMENT TYPE AIR CLEANER MAINTENANCE

The air cleaner element should be cleaned or replaced when the dust indicator light in the cluster comes on.

#### REMOVAL OF CONDENSATE FROM WATER SEPARATOR

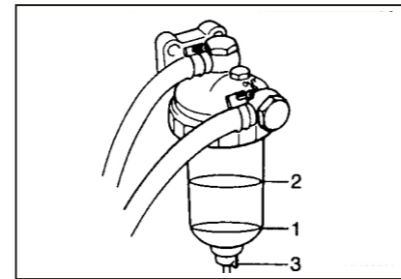

Check the water separator about once a week. Remove the condensate before the float 1 in the

water separator reaches the position of the red line<sup>2</sup>.

To remove the condensate, proceed as follows:

1. Loosen the plug 3 to discharge the condensate.
2. After the float has come down, tighten the plug.
3. Wipe the water separator and its neighborhood clean.
4. Check for fuel leaks.

#### EXHAUST OF FUEL FILTER

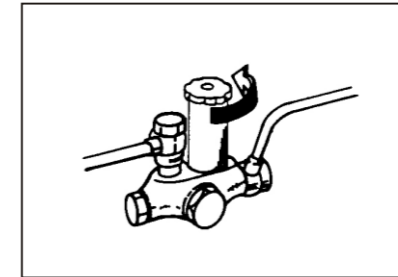

If the engine stops by fuel exhausted, cleaning the fuel system or changing the fuel filter. During fuel adding, air may come into the fuel system, which will cause the engine does not start.

Air should be removed from the fuel system to start your engine.

Relief air by the following procedure:

1. Loosen the air bent cock on the top of the fuel filter.

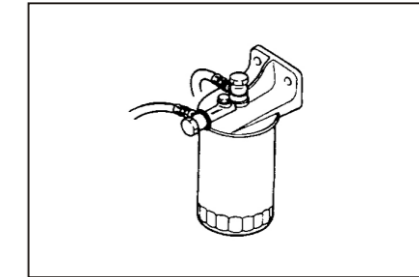

2. Turn the priming pump counterclockwise with pressing down and then the pump piston is pushed out by a spring.
3. Operate the priming pump until the fuel flow out without air bubble.
4. Tighten the air bent cock and fix the pump piston by pressing and turning clockwise.
5. Start the engine and check for fuel leaks.

#### CHECK RADIATOR AND RADIATOR HOSE

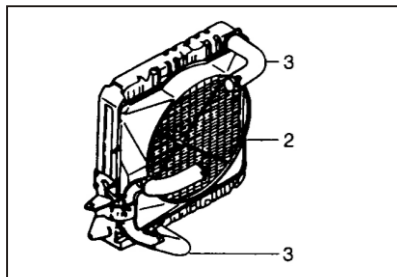

Check the radiator 2, radiator hose 3, etc. for water leaks.

Check for the traces of water leaks on the ground where the vehicle has been parked. If there are water leaks in the cooling system, take the vehicle to the nearest service station for service.

#### ADJUSTABLE GENERATOR FREE PLAY

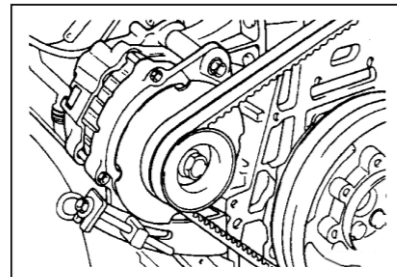

Slightly loosen the generator attaching bolts and adjust by moving the whole generator.

#### CAUTION:

- After adjustment, tighten the bolts and nuts firmly. Over-tension will cause damages to the V-belt and overloading.
- Make sure that the V-belt is not fouled with oil or grease. Oil or grease will cause the belt to slip and will shorten its life.
- When a V-belt is defective, make sure that the two V-belts are replaced as a set.

#### REMOVAL OF CONDENSATE WATER FROM AIR TANK

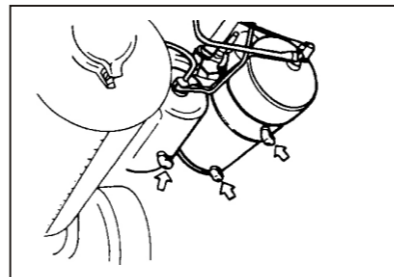

Open all drain cocks to remove the water collected in the air tank.

#### STEERING WHEEL FREE PLAY

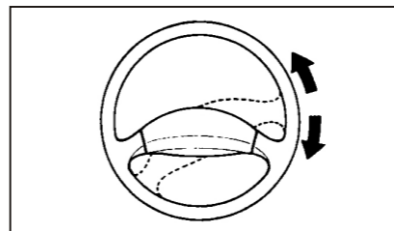

Lightly rock steering wheel at the center position to check for free play. If the free play exceeds 15 to 35 mm, have the steering wheel adjusted by your nearest service station.

#### CHECKING BRAKE PEDAL FREE PLAY

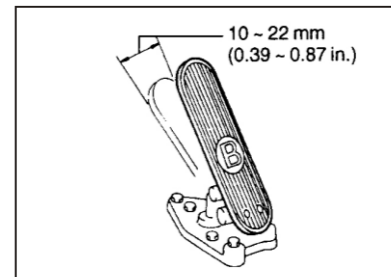

Check the pedal free play by depressing the pedal with finger. The pedal free play is the stroke made by the pedal moves until you feel a

change in resistance. This is the brake pedal free play. The free play should be within the limits specified in the illustration below. If it is not, have it inspected by JAC service station and adjusted or repaired if necessary.

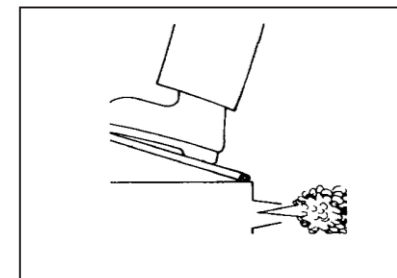

#### CLUTCH PEDAL PLAY

The clutch pedal play will decrease as the disc wears. If it is not adjusted, the clutch will slip, making it impossible to operate the vehicle.

When the clutch pedal play has decreased to less than 8.3 in. (210 mm), adjustment is required.

Check the pedal play by depressing the pedal with finger. Depressing the pedal will make you feel resistance in two stages. The pedal play is the stroke made by the pedal until it reaches the second stage and is 0.24 to 0.31 in. (6 to 8mm) standard. The play in the first stage is the master cylinder play. In the second stage, it is the clutch booster push rod play. The play is easier to check when the compressed air pressure is lower. If it is out of specification, have it inspected and adjusted or repaired if necessary.

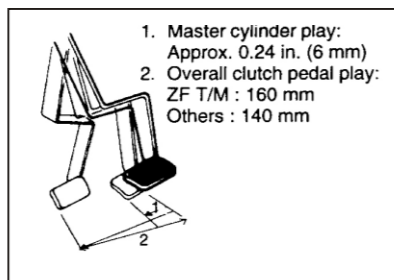

Adjust the clutch master cylinder play, which is the movement of the pedal up to the first resistance encountered when the pedal is depressed with your finger. Adjust this play to about 6 mm (0.24 in.) by turning the center bolt of the master cylinder push rod. After adjusting, firmly tighten the nut on the center bolt while holding the bolt in the proper position.

- 1) Master cylinder play:  
Approx. 0.24 in. (6 mm)
- 2) Master cylinder
- 3) Stroke adjusting nut

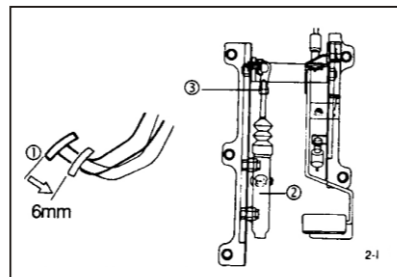

**NOTE:**

If the stroke adjustment cannot meet with the specification, the clutch disc is worn out to the service limit. Take the vehicle to your nearest service station for maintenance.

**EXHAUST OF CLUTCH PIPE**

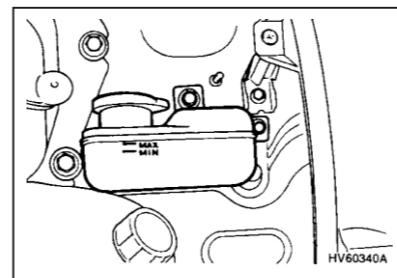

If there is air in the pipe, the clutch will be hard to disengage.

When the fluid reservoir tank has been emptied, be sure that the clutch pipe is exhausted. Have an assistant in exhausting the pipe and proceed as follows:

1. Fill the clutch fluid reservoir tank with brake fluid up to the "MAX" level. Since the level falls during the exhausting operation, add brake fluid

to prevent emptying the tank.

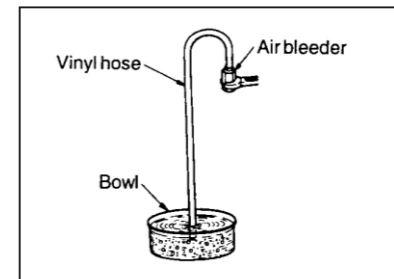

2. Remove the rubber cap from the air bleeder of the clutch booster, mount with one end of a transparent vinyl hose, and put the other end in a bowl containing brake fluid.

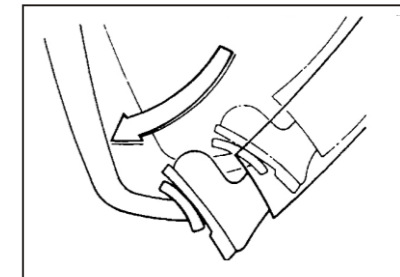

3. Depress the clutch pedal several times. After the stroke has settled, keep the pedal depressed. Let him tighten the air bleeder immediately after air has been discharged.

**NOTE:**

If the brake fluid is discharged from the air bleeder, the stroke of the pedal will change. Tighten the air bleeder immediately after the pedal has touched the stopper.

4. After the air bleeder has been tightened, release the pedal.
5. Repeat steps 3 and 4 until there are no more air bubbles in the brake fluid that run out from the air bleeder. The last step, tighten the air bleeder firmly and install the rubber cap.
6. Check the fluid level in the fluid reservoir tank and add brake fluid up to the "H" level. Depress the clutch pedal to check for fluid leaks.

#### CHECKING THE BRAKE FLUID LEVEL

##### WARNING:

Pay attention when handling brake fluid. It can damage your vision if it gets into your eyes. It will also damage your vehicle paint if spilled on it and not removed immediately.

#### TO CHECK THE FLUID LEVEL (OPTIONAL)

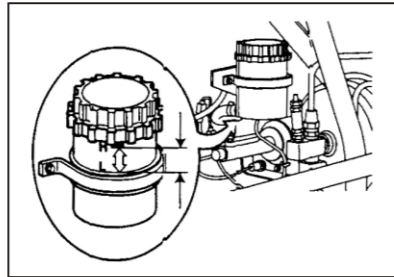

The fluid level in the brake fluid reservoir should be checked periodically. The level should be between the "L" and "H" marks on the side of the reservoir. If the level is at or below the "L" mark, carefully add fluid to bring it up to "H". Do not overfill.

#### COOLANT LEVEL AND LEAKS IN COOLING SYSTEM Checking and changing the engine coolant

##### WARNING:

Do not remove the surge tank cap when the engine is hot. When the engine is hot, the coolant is under pressure and may erupt through the opening if the cap is removed. You could be seriously burned if you do not observe this precaution. Do not remove the surge tank cap until the radiator is cool.

#### Handling of cooling system

Engine overheating is caused by the low coolant level or rust and scale accumulations in the cooling system.

If the radiator clogs very seriously or coolant is very dirty, perform cleaning and coolant replacement as described below. If the coolant level is low, add coolant as necessary.

#### Replace the coolant

If the radiator is seriously blocked or the coolant becomes dirty, it shall be timely replaced. Such replacement shall be done in accordance with procedures in the "Cleaning methods" and ensure that it can clean the cooling system.

#### Cleaning methods

Run the engine at idle speed to preheat the coolant to 90 °C or higher, and then perform following procedures.

1. Turn on the radiator and engine water faucet to drain out coolant.
2. After completely draining out the coolant, turn off all water faucets and fill the system with running water.
3. Turn off all water faucets and fill the system with running water. Run the engine for a while to drain out the system water. Repeat the operation till transparent water flows out from the water faucet.
4. Fill the radiator with running water to make it have real antirust agent "RADIPET 9" or anti-freezing agent. Run the engine till the coolant temperature is up to 90 °C ; in such case, the automatic thermosistor will be turned on and air will be exhausted from the cooling system.



5. Stop the engine to ensure that there is sufficient coolant. If the coolant level is low, fill some running water.

**WARNING:**

When the cooling system is cleaned, the coolant or cleaning solution is drained at high temperature. Therefore, be careful not to get scalded.

**Addition of coolant**

If the warning lamp lights when the starter switch is set to "ON", the coolant level is low. Note that the procedure for adding coolant varies according to the type of the engine cooling system on vehicle. Use city

water as coolant and add anti-rust or anti-freeze to have a specified concentration for prevention of engine or cooling system corrosion.

Do not use hard water from well, river etc.

**ANTI-FREEZE**

Select proper concentration between 30% and 53% by reference to the table shown below.

Atmosphere temperature (°C)	Antifreeze fluid (%)	Coolant (%)
-10	30	70
-15	36	64
-20	42	58
-25	45	55
-30	50	50
-35	53	47

**CAUTION:**

● Be sure to use anti-freeze at the concentration most appropriate for the atmospheric temperature within a range from 30% to 53%. If the concentration is below 30%, the anti-corrosion property will be adversely affected. If the concentration is above 53%, the anti-freeze property will decrease and engine overheating will also be caused. Use anti-freeze at the specified concentration.

● If winter is over, be sure to drain the coolant containing anti-freeze and put in anti-rust "RADIPET 9".

**ADJUSTMENT OF BRAKE SHOE CLEARANCE (AIR BRAKE VEHICLES)**

If the brake linings are worn and the clearance between the brake drum and linings (brake shoe clearance) increases, it can be dangerous because the brake performance deteriorates. Check and adjust the brake shoe clearance at regular intervals.

The brake shoe clearance should be determined on the basis of the stroke of the brake chamber push rod. If the push rod stroke exceeds 40 mm (1.57 in.) on the front wheels or 50 mm (1.97 in.) on the rear wheels when the brake pedal is depressed all the way, adjust the clearance.

1. Apply chocks to the tires before the wheel to be adjusted is jacked

up.

2. Strongly push the outer periphery of tire to check for wheel looseness. If the wheel is loose, it cannot be correctly adjusted. Take the vehicle to your nearest service shop for correction.

3. Start the engine to increase the compressed air pressure to more than 6.4 kgf /cm<sup>2</sup> (625KPa). Leave the engine running at idle.

4. Push the knob of the cab control valve to release the emergency brakes.

5. Remove the dust cap from the wheel brake inspection hole and check the lining thickness. If the lining is worn out to the notch shown in illustration, it is beyond the service

limit. Have your nearest service shop replace the linings. Make sure that the dust cap is reinstalled after inspection.

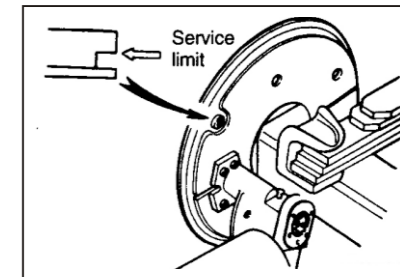

6. Turn the worm shaft of the slack adjuster in the direction that the push rod extends until the worm shaft touches the stopper.

7. Back off the worm shaft 3 or 4 notches on the front wheels or 4 or 5 notches on the rear wheels.

The notches can be exposed when rolling the worm shaft.

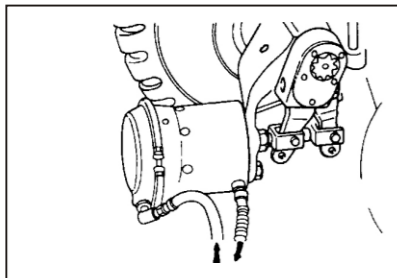

8. Measure the stroke made by the push rod of the brake chamber when the brake pedal is depressed all the way. Verify that the stroke is up to specifications given in the following table. If it is out of specification, adjust with the worm shaft.

Standard stroke of brake chamber push rod.

Front wheel	25 mm (0.98 in.)
Rear wheel	30 mm (1.18 in.)

9. Turn the wheel in the forward direction by hand and depress the brake pedal to stop rotation of the wheel. Turn the wheel to check for dragging. With slight pressure on the brake pedal, turn each wheel by hand to check that the front wheels are slightly lighter to turn than the rear wheels or there is not great difference and that right and left wheels are about equal.

10. As a final step, install the dust plug. Operate the vehicle at a slow speed and perform brake tests to check for brake performance, uneven braking and other troubles.

#### ENGINE OIL LEVEL

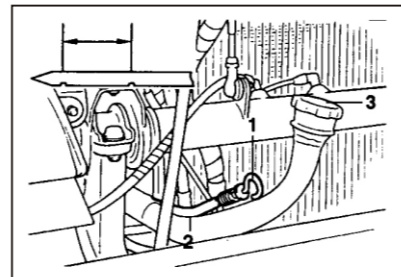

Position the vehicle on a level surface. The best time to check the oil level is before operating the engine or about 30 minutes after engine stop.

The checking procedure is as follows:

1. Wipe the level gauge 1 well with a cloth, insert it into the level gauge guide 2 and remove the

gauge to check the oil level. The oil level should be between "FULL" and "LOW" inscribed lines.

#### NOTE:

If the oil level is checked when the engine is stopped before sufficient rise of oil temperature, the detected level will be lower than the actual level, because some oil accumulation in the engine does not flow back into the oil pan.

2. If the level is low, add engine oil through the filler cap 3. After adding engine oil, allow more than six minutes and then recheck the oil

level.

3. If a badly contaminated engine oil is obvious when checking the oil level, replace the engine oil in spite of the service intervals.

#### OIL FILTER

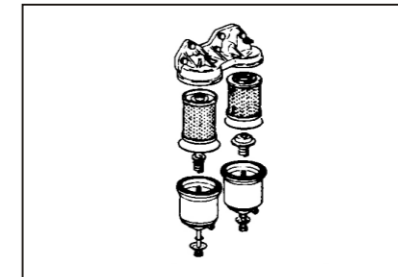

● The engine oil and filter should be changed at those intervals specified in the maintenance schedule. If the truck is being

driven in severe conditions, more frequent oil and filter changes are required.

● If the filter is blocked, the warning light will be on. If the oil pressure is low, the buzzer sounds at the same time. Replace it regardless of the mileage.

● An assembly element cannot be reused.



#### WINDSHIELD WASHER FLUID LEVEL

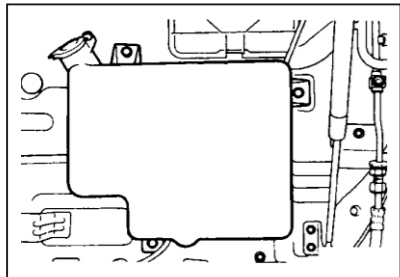

Check to ensure that windshield washer fluid is at a proper level.

#### OPERATION OF WIPERS

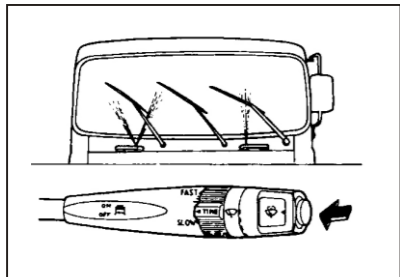

- Push the knob to check that the windshield washer fluid is sprayed at the correct position.
- Turn the lever and check the wipers for proper operation.

#### NOTE:

Be sure to operate the windshield washer before the wipers are operated.

Do not operate the wipers on dry glass. This can result in more rapid wear of the wiper blades and may scratch the glass.

#### TURBOCHARGER Principle of turbo charger operation

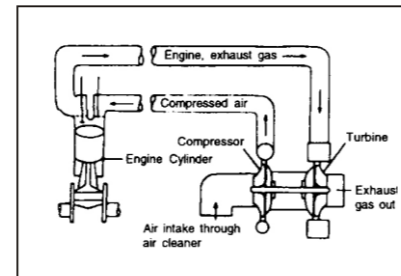

Turbo engine is a device that produces more power by supplying sufficient air into the combustion chamber with the energy of exhaust gas which is usually wasted in the general engine.

The exhaust gases are accelerated in the turbine housing and directed onto the turbine wheel to turn it.

This spins the compressor wheel, which results in the intake air being forced into the engine cylinders.

The intercooler installed improves the fuel economy and power of the engine, while reducing harmful exhaust gases to a minimum.

#### INTERCOOLER

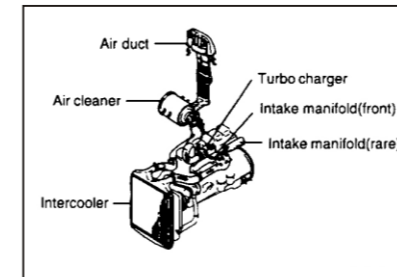

The intake air compressed by the turbocharger increases to 170°C And

as a result, power of the engine is limited by engine overheated. The intercooler cools the hot air. This improves the combustion efficiency and as a result, it increases the fuel economy and power of the engine, while reducing harmful exhaust.

#### PRECAUTIONS WHILE OPERATING

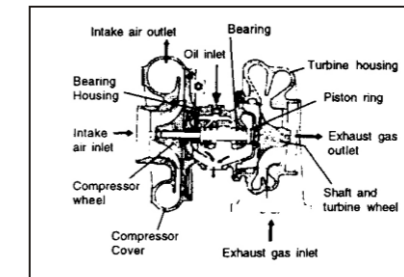

1. Check the oil level and oil pressure before starting the engine, measure the crankcase oil level. As

soon as the engine starts, check oil pressure indicator for normal rise.

2. Warm the engine up after the engine starts, avoid sudden acceleration or sudden start.

Enough RPM is needed before starting engine until the engine is warmed for 3 to 10 minutes.

3. No sudden acceleration or sudden start. If you accelerate, start or turn off the engine suddenly, it may damage the engine and turbocharger parts.

CAUTION:

- If running a vehicle without air cleaner filter, foreign material drawn can destroy engine and turbo charger.
- When you turn off an engine suddenly, it may damage bearing, hi-speed rotation parts of turbo charger inside. So, let the engine run at idle for sufficient time.

BATTERY INSTRUCTIONS



Check the electrolyte in the battery and the status light, make sure it remains green.

CLEANING OF BATTERY TERMINALS

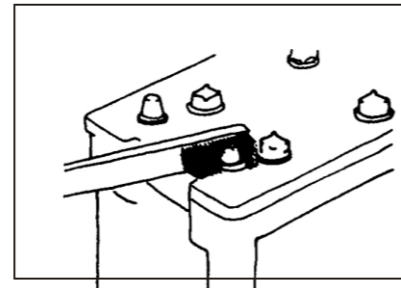

1. Clean the battery terminals if they are stained or corroded. If there is white powder on the terminals, wash with hot water.
2. Remove and polish the terminals with a wire brush or emery paper if they are markedly corroded.
3. Apply a thin coat of grease to the terminals after cleaning and tightening.

NOTE:

The terminals must be firmly tightened. Before cleaning the terminals, make sure the caps are installed securely to prevent foreign matter from entering the battery.

REPLACEMENT OF FUSE

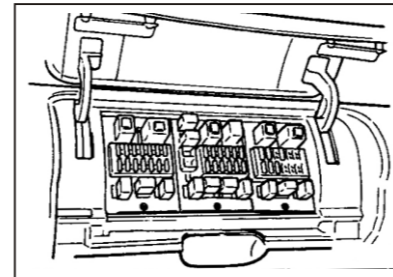

If the electrical system is out of order, open the cover and check for the fuse in the following sequence:

1. Open the cover.
2. Check the fuse; if damaged, timely replace it.
3. When checking the ceiling lamp circuit, turn the ceiling lamp switch to the position "ON".

CAUTION:

- Use of a fuse out of specification or wire could be dangerous. Be sure not to use a substitute fuse. Make sure that a blown fuse is replaced with a genuine fuse.

If a defective point cannot be located, have inspection made at your nearest service station.

- Do not pour water over the relay and fuse box. Do not put your foot on the box or kick it. When the inside of the cab was cleaned with water, remove the water completely through the drain hole in the floor and then tilt the cab.

#### REPLACING LIGHT BULBS

Before attempting to replace a light bulb, be sure the switch is turned to the "OFF" position and place the ignition switch in the "LOCK" position. Be sure to replace the burned-out bulb with one of the same number and power.

## CONSUMER INFORMATION

### VIN CODE AND NAMEPLATE

Please take note of the VIN code, which will be needed when you maintain and repair the vehicles.

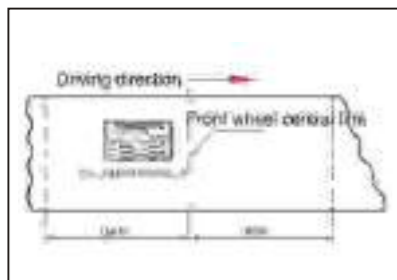

The nameplate and VIN code are located on the right longeron of the frame, about 400mm behind the first axle (the first front axle, if there are two front axles).

The model, chassis number, engine number and VIN code are stamped on the nameplate.

### TIRE ROTATION

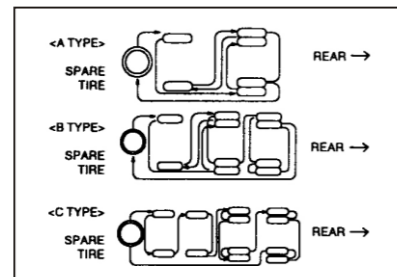

Tires should be rotated every 8,000 km (5,000 miles). If you notice that tires are wearing unevenly, have the truck checked by a JAC service station.

After rotating, adjust the tire pressure and be sure to tight the wheel nut.

### NOTE:

- Do not mix bias-ply tire and radial-ply tire under any circumstances.
- In the situation of double rear wheel, the difference of outer diameter between outer wheel and inner wheel is less than 12mm.

### PRECAUTIONS BEFORE HIGH SPEED OPERATION

The higher the vehicle speed, the more heat the tires generate, and eventually there is a danger or a burst.

The heat generated by the tires varies greatly with the tire pattern, tire inflation pressure, load and

speed. Pay attention to the following points.

- Keep the tires inflated at normal pressure. Avoid overloading.

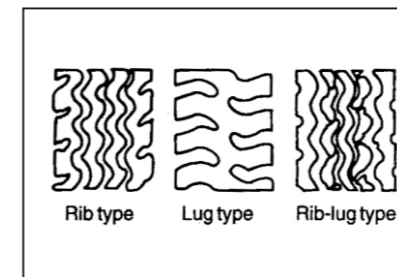

- The lug type tires are not suited for high speed operation, as they tend to skid. If your vehicle is equipped with the lug type tires, not operate it at a very high speed. Exercise controlling the steering wheel and applying brakes on a wet road surface.

### BE SURE TO CHECK THE FOLLOWINGS WHEN LOADING

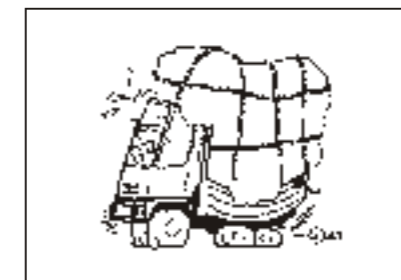

Do not load cargo on one side only. Make sure that the cargo is evenly distributed.

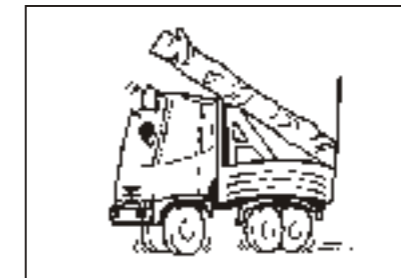

When long cargoes are to be loaded, use rigid frames to minimize their protrusion from the end of the body.

### NOTE:

Be careful about the height of loading.

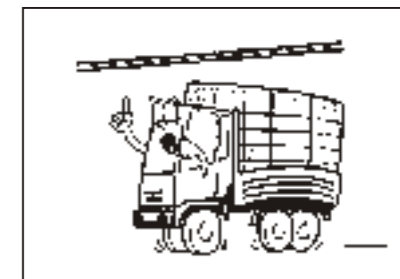

- When the rigid frames are under the cargo, pay attention to the

positions of the frames.

- Place a sheet over the cargo and positively fasten the ropes to prevent the cargo from getting out of position. Make sure that the sheet is securely fastened and does not flap with the wind.

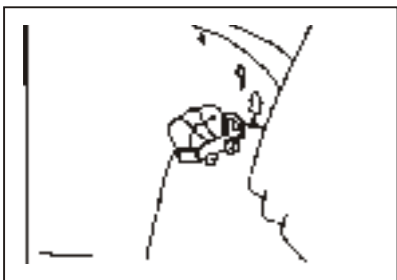

- If the cargo is loaded to an excessive height, the vehicle might overturn on turns.
- If the engine shuts down

because of lack of fuel during operation, the air will enter the fuel system and the engine won't start even after the fuel tank is refilled.