

FOREWORD

This manual covers the service procedures of the TOYOTA FORKLIFT 5FGC/5FDC18-30 Series. Please use this manual for providing quick, correct servicing of the corresponding forklift models.

This manual deals with the above models as of August 1986. Please understand that disagreement can take place between the descriptions in the manual and actual vehicles due to change in design and specifications. Any change or modifications thereafter will be informed by Toyota Industrial Vehicles' Parts & Service News.

For the service procedures of the mounted engine, read the repair manuals listed below as reference together with this manual.

(Reference)

Repair manuals related to this manual are as follows:

*TOYOTA INDUSTRIAL VEHICLE 4Y ENGINE
REPAIR MANUAL (No. CE602)*

*TOYOTA INDUSTRIAL VEHICLE 2J ENGINE
REPAIR MANUAL (No. CE603)*

TOYOTA MOTOR CORPORATION

SECTION INDEX

	SECTION
GENERAL	0
ENGINE	1
TORQUE CONVERTER	2
PROPELLER SHAFT	3
DIFFERENTIAL	4
FRONT AXLE	5
REAR AXLE	6
STEERING	7
BRAKE	8
BODY	9
MATERIAL HANDLING SYSTEM	10
MAST	11
CYLINDER	12
OIL PUMP	13
OIL CONTROL VALVE	14
APPENDIX	15

GENERAL

	Page
VEHICLE EXTERIOR VIEWS	0-2
VEHICLE MODELS	0-3
ABBREVIATIONS & TIPS ON OPERATION	0-4
STANDARD BOLT & NUT TIGHTENING TORQUE ...	0-5
PRECOAT BOLTS	0-7
HIGH PRESSURE HOSE FITTING TIGHTENING TORQUE	0-7
FRAME NUMBER	0-8
SAFE LOAD BY WIRE ROPE SUSPENSION ANGLE	0-8
WIRE ROPE SUSPENSION ANGLE LIST	0-9
CAPACITY AND TYPES OF SPECIFIED LUBRICANTS	0-10
LUBRICATION	0-11
PERIODIC MAINTENANCE TABLE	0-12
PERIODIC REPLACEMENT PARTS & LUBRICANTS	0-19

VEHICLE EXTERIOR VIEWS



Vehicle Front View

LAP18-8

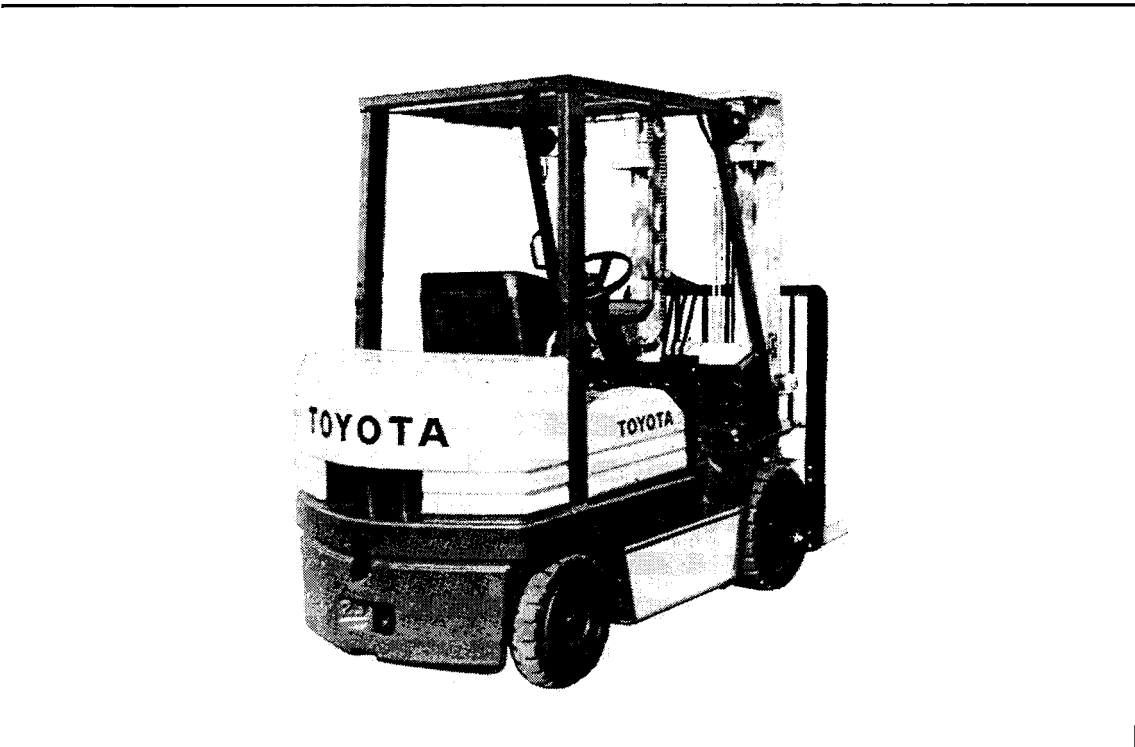

Vehicle Rear View

LAP18-4

VEHICLE MODELS

Series	Payload	Model	Mounted engine	Engine type	Power transmission	Remarks
2 ton series	1.75 ton	5FGC18	4Y	Gasoline	Torque converter	PS equipped as standard
	2.0 ton		4Y 2J	Gasoline Diesel	Torque converter	†
	2.25 ton	5FGC23	4Y	Gasoline	Torque converter	†
	2.5 ton	5FGC25 5FDC25	4Y 2J	Gasoline Diesel	Torque converter	†
3 ton series	2.75 ton	5FGC28	4Y	Gasoline	Torque converter	†
	3.0 ton	5FGC30 5FDC30	4Y 2J	Gasoline Diesel	Torque converter	

ABBREVIATIONS

The abbreviations used in this manual are as follows:

Abbreviation	Meaning	Abbreviation	Meaning
ABDC	After bottom dead center	P/S	Power steering
ASSY	Assembly	RH	Righthand
ATDC	After drop dead center	SAE	Society of Automotive Engineers
BBDC	Before bottom dead center	SST	Special service tool
LH	Lefthand	STD	Standard
LLC	Long life coolant	SUB-ASSY	Subassembly
OHV	Overhead valve	T=	Tightening torque
OPT	Option	OOT	Number of teeth (OO)
O/S	Oversize	U/S	Undersire
PS	Horsepower		

TIPS ON OPERATION

1. Safe operation
 - (1) Make sure that correct size wire rope is used when lifting a heavy material.
 - (2) After jacking up, always support with a rigid rack or stand.
2. Preparation of SSTs and measuring Instruments
 - (1) Prepare necessary SSTs and measuring instruments before starting repair operation.
3. Neatness and underlines
 - (1) Keep the working place neat and orderly to make operation easier.
 - (2) Hydraulic equipment should be disassembled with clean tools in clean places.
4. Genuine Toyota parts

Always use genuine Toyota parts even for packings, gaskets and o-rings which are replaced after each disassembly work.
5. Repairs on electrical system

Before doing any repair on the electrical system, disconnect the cables from battery terminals.
Always disconnect the negative (—) terminal first.
6. Tightening torque at the time of installation

Be sure to observe the tightening torque given in this manual. If not specified, tighten to the torque listed in "Standard Bolt & Nut tightening Torques."
7. Grasping the defect status

When a defect is found, do not immediately start disassembly and replacement. First check if the defect needs disassembly and replacement for repair. For example, do not disassemble the torque converter for a defect of vehicle starting failure but check such factors as the oil status, hydraulic pressure and rotation which directly cause the defect.

STANDARD BOLT & NUT TIGHTENING TORQUE







Standard bolt and nut tightening torques are not indicated
Therefore, judge the tightening torque as described below

- 1 Find out the type of bolt from the list below Then, judge the bolt tightening torque from the tightening torque table
- 2 The nut tightening torque can be judged in the same way according to the type of the mating bolt

DISCRIMINATION OF BOLT STRENGTH

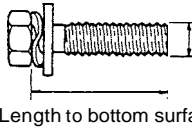
1 Discrimination by actual bolt

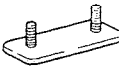
2 Discrimination by part number

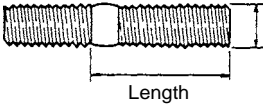
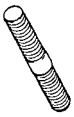
	Shape and description	Strength code	Hexagon bolt
Hexagon bolt Standard head	 Number in relief or hallmark on head	4=4T 5=5T 6=6T 7=7T	Part number example 9 1 1 1 1 - 4 06 10 ↳ Length under head (mm) ↳ Nominal size (mm) ↳ Strength code
	 No mark	4T	
Hexagon bolt Collar head	 No mark	4T	
Hexagon bolt Standard bolt	 Bolt with two relief lines on head	5T	
Hexagon bolt Collar head	Bolt with two relief lines on head	6T	
Hexagon bolt	Bolt with three relief lines on head	7T	Stud bolt Part number example 9 2 1 3 2 - 4 06 14 ↳ Length under head (mm) ↳ Nominal size (mm) ↳ Strength code
Weld bolt	 4T	4T	
Stud bolt	 No mark	6T	
	 Approx. 2mm hollow on either or both ends		

TIGHTENING TORQUE TABLE

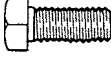
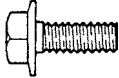
Strength code	Nominal size mm	Pitch mm	Standard tightening torque kg-cm (ft-lb)	
			Standard head 	Collar head 
4T	6	1.0	55 (4.0)	60 (4.3)
	8	1.25	130 (9.4)	145 (10.5)
	10	1.25	260 (18.8)	290 (29.9)
	12	1.25	480 (34.7)	540 (39.0)
	14	1.5	760 (54.9)	850 (61.4)
	16	1.5	1150 (83.0)	—
5T	6	1.0	65 (4.7)	—
	8	1.25	160 (11.1)	—
	10	1.25	330 (23.8)	—
	12	1.25	600 (43.3)	—
	14	1.5	930 (67.1)	—
	16	1.5	1400 (101.1)	—
6T	6	1.0	80 (5.8)	90 (6.5)
	8	1.25	195 (14.1)	210 (15.2)
	10	1.25	400 (28.9)	440 (31.8)
	12	1.25	730 (52.7)	810 (58.5)
	14	1.5	1100 (79.4)	1250 (90.3)
7T	6	1.0	110 (7.9)	120 (8.7)
	8	1.25	260 (18.8)	290 (20.9)
	10	1.25	530 (38.3)	590 (42.6)
	12	1.25	970 (70.0)	1050 (75.8)
	14	1.5	1500 (108.3)	1700 (122.7)
	16	1.5	2300 (166.1)	—

PRECOAT BOLTS

(Bolts coated with seal lock agent on threads)

- 1 Do not use the precoat bolt as it is in any of the following cases
 - (1) When the precoat bolt is removed
 - (2) When the precoat bolt is moved (loosened or tightened) in tightening check etc

Reference :

The tightening torque must be checked with the lower limit of the allowable tightening torque range. If the bolt moves, retighten it according to the following procedure:

2. Reusing the precoat bolt
 - (1) Clean the bolt and threaded hole. (Clean the threaded hole even when the precoat bolt is to be replaced.)
 - (2) Dry the precoat bolt sufficiently by air blowing, etc
 - (3) Coat the specified seal lock agent on the threaded hole for the bolt.

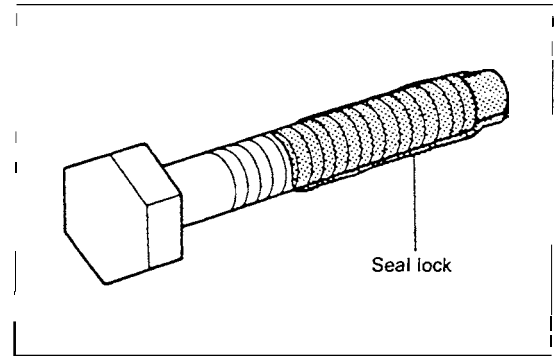

Precoat Bolts

84460

HIGH PRESSURE HOSE FITTING TIGHTENING TORQUE

1. Before connecting a high pressure hose, wipe the high pressure hose fitting and mating nipple contact surfaces with clean cloth to remove foreign matters and dirt. Check that there is no dent or other surface defect on the contact surface.
2. Align the high pressure hose fitting and nipple and hold the hose in that the state during tightening.
3. The maximum tightening torque must not exceed twice the standard tightening torque.

Nominal diameter of screw	Standard tightening torque kg-cm (ft-lb)		Hose inside diameter mm
	Standard	Tightening range	
7/16 —20UNF	2.5 (181)	24 — 2.6 (17.3 ~ 188)	6
9/16 —18UNF	5.0 (362)	48 — 53 (347 — 383)	9
3/4 —16UNF	6.0 (433)	57 — 6.3 (412 — 455)	12
7/8 —14UNF	6.0 (433)	57 — 6.3 (412 ~ 45.5)	12
1 1/16—12UNF	12.0 (866)	114 ~ 12.6 (82.3 ~ 91 0)	19
1 5/16—12UNF	15.0 (101 1)	13.3 ~ 14.7 (96.0 ~ 106.1)	25
PF1/4	5.0 (362)	48 — 5.3 (34.7 ~ 383)	9
PF3/8	5.0 (362)	48 — 5.3 (34.7 ~ 383)	9
PF1/2	6.0 (43.3)	57 — 6.3 (41 2 — 455)	12
PF3/4	12.0 (86.6)	114 ~ 12.6 (82.3 ~ 91 0)	19
PF1	14.0 (101 1)	133 — 147 (1960 — 1061)	25

FRAME NUMBER

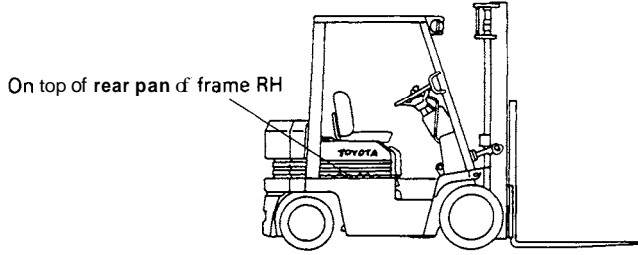
Frame serial number location	 <p>On top of rear pan of frame RH</p> <p style="text-align: right;">LAPS1</p>			
Model series	2.0 ton series		3.0 ton series	
Engine type	4Y	2J	4Y	2J
Model	5FGC18 5FGC20 5FGC23 5FGC25	5FDC20 5FDC25 — —	5FGC28 5FGC30 — —	5FDC30 — — —
Frame serial number format	5FGC25—10001 *5FGC25E10001	5FDC25—10001 *5FDC25E10001	5FGC30—10001 *5FGC30E10001	5FDC30—10001 *5FDC30E10001

*. EEC spec. (1992. 11—)

SAFE LOAD BY WIRE ROPE SUSPENSION ANGLE

Unit: ton (lb)

Rope diameter	Breakdown load	Unifilar suspension	Bifilar suspension					Cross slinging			
			0°	0"	30"	60"	90"	0°	30"	60°	90"
6 mm (0.24 in)	2.18 (4807)	0.31 (683.6)	0.62 (1367)	0.6 (1323)	0.53 (1169)	0.44 (970)	1.24 (2734)	1.2 (2646)	1.06 (2337)	0.88 (1940)	
8 mm (0.32 in)	3.21 (7078)	0.45 (992.3)	0.9 (1985)	0.87 (1918)	0.78 (1720)	0.64 (1411)	1.8 (3969)	1.74 (3837)	1.56 (3440)	1.28 (2822)	
10 mm (0.4 in)	5.02 (11069)	0.71 (1565.6)	1.4 (3153)	1.3 (3021)	1.2 (2646)	0.9 (2205)	2.8 (6174)	2.7 (5954)	2.4 (5292)	2.0 (4410)	
12.5 mm (0.5 in)	7.84 (17287)	1.12 (2469.5)	2.2 (4851)	2.1 (4631)	1.9 (4190)	1.5 (3308)	4.4 (9702)	4.2 (9261)	3.8 (8379)	3.0 (6615)	
14 mm (0.56 in)	9.83 (21675)	1.4 (3087.0)	2.8 (6174)	2.7 (5954)	2.4 (5292)	1.9 (4190)	5.6 (12348)	5.4 (11907)	4.8 (10584)	3.8 (8379)	

WIRE ROPE SUSPENSION ANGLE LIST

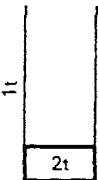
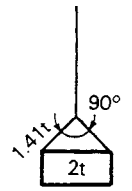
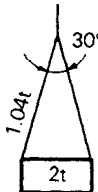
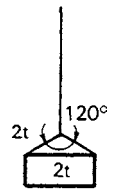
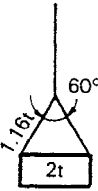
Suspension angle	Tension	Compression strength	Suspension method	Suspension angle	Tension	Compression strength	Suspension method
0°	1.00 times	0 times		90°	1.41 times	1.00 times	
30°	1.04 times	0.27 times		120°	1.73 times	1.73 times	
60°	1.16 times	0.58 times					

LAPS2

CAPACITY AND TYPES OF SPECIFIED LUBRICANTS

Description		Classification	Type	Application	Quantity
Engine	Gasoline	API SD, SE, SF	Motor oil SAE30 (SAE20 in cold area) SAE20W-40 (SAE10W-30 in cold area)	4Y	4.01 (1.06 US gal)
	Deisel	API CC, CD	Diesel engine oil SAE30 (SAE20 in cold area) SAE10W-30	2J	6.91 (1.82 US gal)
Torque converter		ATF	GM Dexron® II	All models	14.0ℓ (3.70 US gal)
Differential		API GL-4 GL-5	Hypoid gear oil SAE85W-90	All models	6.81 (1.80 US gal)
Hydraulic oil		ISO VG32	Hydraulic oil #90	2 ton series 3 ton series	27P (7.1 US gal) 281 (7.4 US gal)
Fuel tank				All models	45P (12 US gal)
Chassis parts			MP grease No.2	All models	Proper quantity
Coolant		LLC	<ul style="list-style-type: none"> • LLC 30-50% mixture (for winter or all-season) • Coolant with rustinhibitor (for spring, summer and autumn) 	4Y 2J	9.0ℓ (2.38 US gal) 9.51 (2.51 US gal)

LUBRICATION

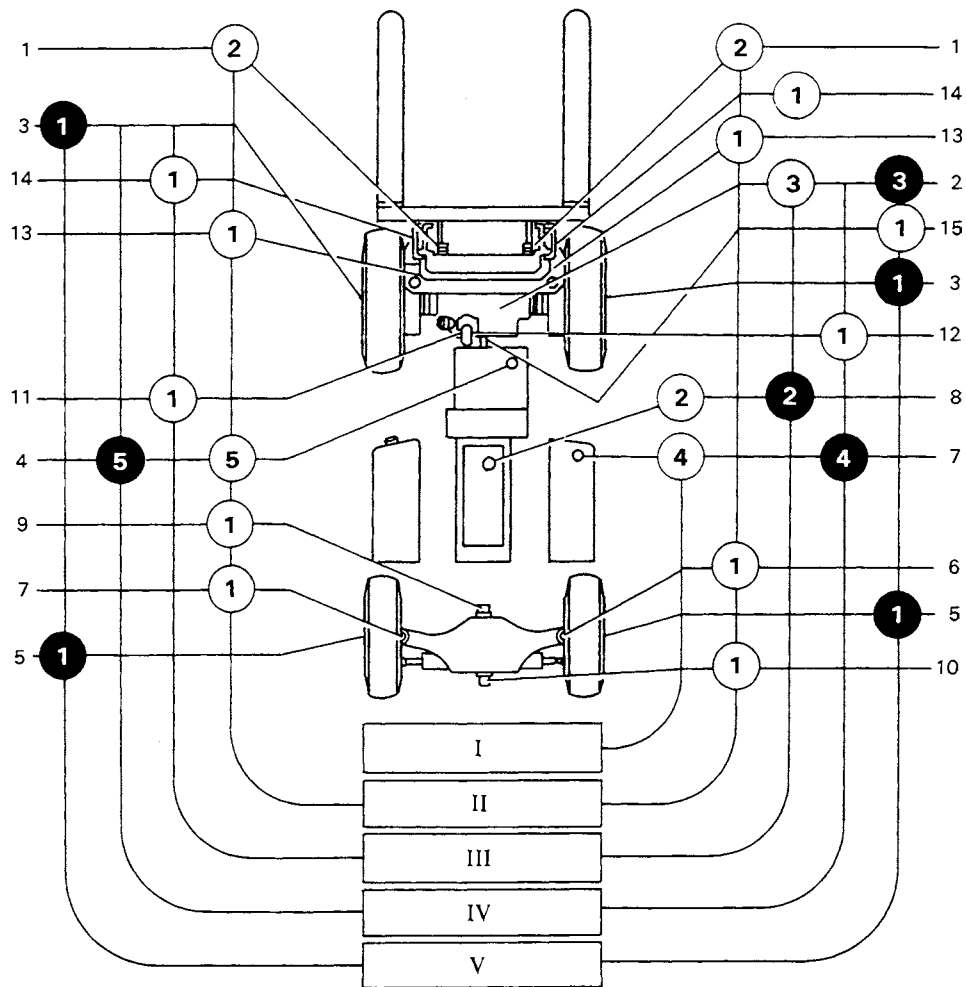

- | | |
|------------------------------------|---|
| 1 Chain | I Inspect every 8 hours (daily) |
| 2 Differential | II Inspect every 40 hours (weekly) |
| 3 Front wheel bearing | III inspect every 170 hours (monthly) |
| 4 Torque converter case | IV Inspect every 1000 hours (6 monthly) |
| 5 Rear wheel bearing | V Inspect every 2000 hours (annually) |
| 6 Steering knuckle king pin | ○ Inspect and service |
| 7 Oil tank | ● Replace |
| 8 Engine crank case | 1 MP grease |
| 9 Rear axle beam front | 2 Engine oil |
| 10 Rear axle beam rear | 3 Hypoid gear oil |
| 11 Tilt steering universal joint | 4 Hydraulic oil |
| 12 Tilt steering locking mechanism | 5 Automatic transmission fluid |
| 13 Mast support bushing | |
| 14 Tilt cylinder front pin | |
| 15 Propeller shaft | |

Lubrication Chart

PERIODIC MAINTENANCE TABLE

INSPECTION METHOD

I : Inspect and Correct or replace as required. M : Measure and correct or adjust as required

T : Tighten C : Clean L : Lubricate

* : For new vehicle *1 : Soapy water *2 : Detector *3 : Flaw detector

Place	Inspection item	Inspection period				Months	
		Every	1	3	6	12	
		Every	170	500	1000	2000	Hours
ENGINE							
Engine proper	Starting status and abnormal noise	I	←	←	←		
	Revolution in idling state	M	←	←	←		
	Revolution during acceleration	M	←	←	←		
	Exhaust gas	I	←	←	←		
	Air cleaner element	C	←	←	←		
	Valve clearance	M*				M	
	Compression					M	
	Cylinder head bolt loosening	T*				T	
Positive crankcase ventilation (PCV)	Clogging and damage of PCV valve and piping	I	←	←	←		
Governor	No-load maximum engine speed	M	←	←	←		
Lubrication system	Oil leakage	I	←	←	←		
	Oil level	I	←	←	←		
	Clogging and fouling of oil filter	I	←	←	←		
Fuel system	Fuel leakage	I	←	←	←		
	Carburetor link mechanism operation	I	←	←	←		
	Fouling and damage of oil filter element	I	←	←	←		
	Injection timing				M	←	
	Injection nozzle injection pressure and spray status					M	
Cooling system	Radiator cooling water level and leakage	I	←	←	←		
	Rubber hose deterioration	I	←	←	←		
	Radiator cap status	I	←	←	←		
	Fan belt tension, looseness and damage	I	←	←	←		
	Damage and hardening of radiator rubber mount					I	

Place	Inspection item	Inspection period				Months	
		Every	1	3	6		12
		Every	170	500	1000	2000	Hours
LPG fuel system	Gas leakage from piping and joints	*1	←	←	←		
	Damage of piping and joints	*2	→	←	←		
	Vaporizer tar discharge	C	←	←	←		
	Looseness and damage of gas cylinder mounting	I	←	←	←		
POWER TRANSMISSION SYSTEM							
Differential	Oil leakage	I	←	←	←		
	Oil level	I	←	←	←		
	Loose bolts					T	
Torque converter and transmission	Oil leakage	I	←	←	←		
	Oil level	I	←	←	←		
	Operating mechanism function and looseness	I	←	←	←		
	Control valve and clutch functions	I	←	←	←		
	Inching valve function	I	←	←	←		
	Stall test and oil pressure measurement				M	←	
Propeller shaft and axle shaft	Loose joint		I	←	←		
	Looseness at spline connection					I	
	Looseness at flexible joint					I	
	Axle shaft torsion and crack					I	

Place	Inspection item	Inspection period	1	3	6	12	Months
		Every	170	500	1000	2000	Hours
TRAVELING EQUIPMENT							
Wheels	Tire cuts, damage and uneven wear	I	←	←	←		
	Loose rim and hub nuts	T	←	←	←		
	Tread depth	M	←	←	←		
	Metal fragments, stones or other foreign matters on tires	I	←	←	←		
	Rim, side bearing and disc wheel damage	I	←	←	←		
	Front wheel bearing abnormal sound and looseness	I	←	←	←		
	Rear wheel bearing abnormal sound and looseness	I	←	←	←		
Front axle	Housing crack, damage and deformation					I	
Rear axle	Beam crack, damage and deformation					I	
	Looseness of axle beam in vehicle longitudinal direction	M*				M	
STEERING SYSTEM							
Steering wheel	Play and looseness	I	←	←	←		
	Operating status	I	←	←	←		
Gear box	Oil leakage	I	←	←	←		
	Looseness of installation	T	←	←	←		
Power steering	Oil leakage	I	←	←	←		
	Looseness of mounting and linkage	I	←	←	←		
	Power steering hose damage					I	

Place	Inspection item	Inspection period	1	3	6	12	Months
		Every	170	500	1000	2000	Hours
Knuckle	King pin looseness Crack and deformation		I	←	←	←	I
Steering axle	Wheel alignment Left and right turning angles					M M	
BRAKING SYSTEM							
Brake pedal	Play and reserve Braking effect		M I	← ←	← ←	← ←	
Parking brake	Pull margin Braking effect Looseness and damage of rod and cable Looseness and damage of level link		I I I	← ← ←	← ← ←	← ← ←	I
Brake piping	Leakage, damage and installation status		I	←	←	←	
Master cylinder or brake valve and wheel cylinder	Function, wear, damage, oil leakage and loosening of installation					I	
Brake drum and brake shoe	Clearance between drum and lining Wear at shoe sliding contact portion and lining Drum wear and damage Shoe operating state Anchor pin rusting Fatigue of return spring Automatic adjusting mechanism function		M	←	←	←	I I I I M I
Backing plate	Deformation, crack and damage Looseness of mounting					I T	

Place	Inspection period Inspection item	Every	1	3	6	12	Months
		Every	170	500	1000	2000	Hours
MATERIAL HANDLING SYSTEM							
Fork	Abnormality of fork and stopper pin		←	←	←		
	Left and right fork blade misalignment		←	←	←		
	Crack at fork base and welded portion					*3	
Mast and fork bracket	Deformation and damage of each part, crack at welded portion		←	←	←		
	Looseness of mast and lift bracket		←	←	←		
	Mast support bush wear and damage						
	Roller wear, damage and rotation status	←	←	←			
	Roller pin wear and damage						
	Mast strip wear and damage		←	←	←		
Chain and chain wheel	Chain tension, deformation and damage		←	←	←		
	Chain lubrication		←	←	←		
	Abnormality of chain anchor bolt		←	←	←		
	Chain wheel wear, damage and rotation status		←	←	←		
Attachments	Abnormality and installation status of each attachment		←	←	←		
HYDRAULIC SYSTEM							
Cylinder	Looseness and damage of cylinder mounting	T	←	←	←		
	Deformation and damage of rod, rod screw and rod end		←	←	←		
	Cylinder operation		←	←	←		
	Natural drop and natural forward tilt	M	←	←	←		
	Oil leakage and damage		←	←	←		
	Wear and damage of pin and cylinder bearing		←	←	←		
	Lifting speed	M	←	←	←		
	Uneven movement		←	←	←		
Oil pump	Oil leakage and abnormal sound		←	←	←		

Place	Inspection item	Inspection period					Months
		Every	1	3	6	12	Hours
		Every	170	500	1000	2000	
Hydraulic oil tank	Oil level and contamination		I	←	←	←	
	Tank and oil strainer				C	←	
	Oil leakage		I	←	←	←	
Control lever	Looseness of linkage		I	←	←	←	
	Function		I	←	←	←	
Oil control valve	Oil leakage		I	←	←	←	
	Relief pressure measurement					M	
	Relief valve and tilt lock valve functions		I	←	←	←	
Hydraulic piping	Oil leakage		I	←	←	←	
	Deformation and damage		I	←	←	←	
	Looseness of joints		T	←	←	←	
	Hose tension and torsion		I	←	←	←	
ELECTRICAL SYSTEM							
Ignition system	Crack of distributor cap		I	←	←	←	
	Spark plug burning and gap		I	←	←	←	
	Distributor side terminal burning		I	←	←	←	
	Wear and damage of distributor cap center terminal		I	←	←	←	
	Open-circuit in plug cord						I
	Ignition timing				M	←	
Starting motor	Pinion gear meshing		I	←	←	←	
Charger	Charging performance		I	←	←	←	
Battery	Battery fluid level		I	←	←	←	
	Specific gravity				M	←	
Electrical wiring	Wire harness damage		I	←	←	←	
	Fuses		I	←	←	←	

Place	Inspection period Inspection item	Every	1	3	6	12	Months
		Every	170	500	1000	2000	Hours
Preheater	Open circuit in glow plug				I	←	
	Open circuit in intake heater				I	←	
Engine stop device	Diesel engine key stop device function		I	←	←	←	
SAFETY DEVICES, ETC.							
Head guard	Crack at welded portion		I	←	←	←	
	Deformation and damage		I	←	←	←	
Back rest	Looseness of installation		T	←	←	←	
	Deformation, crack and damage		I	←	←	←	
Lighting system	Function and installation status		I	←	←	←	
Horn	Function and installation status		I	←	←	←	
Turn signal indicator	Function and installation status		I	←	←	←	
Instruments	Function		I	←	←	←	
Back-up buzzer	Function and installation status		I	←	←	←	
Muffler	Damage and hardening of muffler rubber mount					I	
Rear view mirror	Dirt and damage		I	←	←	←	
	Rear view reflection status		I	←	←	←	
Seat	Looseness of installation and damage		I	←	←	←	
Body	Damage and crack of frame cross member, etc.					I	
	Bolt looseness					T	
Others	Lubrication		L	←	←	←	

PERIODIC REPLACEMENT PARTS & LUBRICANTS

● Replacement

Item	Replacement intervals	Every month	Every three months	Every six months	Every 12 months
		Every 170 hours	Every 500 hours	Every 1,000 hours	Every 2,000 hours
Engine oil		● a	←	←	←
Engine oil filters		(Vew vehicle)	●	←	←
Cooling water (except for LLC, every two years for LLC)			●	←	←
Fuei filter				●	←
Torque converter oil				●	←
Torque converter oil filter					●
Differential oil				●	←
Hydraulic oil				●	←
Hydraulic oil filter		● (Vew vehicle)		●	←
Wheel bearing grease					●
Spark plug				●	←
Cyclone air cleaner element					●
Brake valve rubber parts					●
Master and wheel cylinder cups and seals					●
Power steering hose					● (Every two years)
Power steering rubber parts					a (Every two years)
Hydraulic hose					● (Every two years)
Reservoir tank tube					● (Every two years)
Fuel hose					● (Every two years)
Torque converter rubber hose					● (Every two years)
Chain					● (Every three years)

Carry out according to operating hours or months, whichever comes earlier

ENGINE

	Page
GENERAL	1-2
ENGINE PERFORMANCE	1-4
ENGINE PERFORMANCE CURVES	1-5
ENGINE ASSY W/TORQUE CONVERTER TRANSMISSION	1-7
ENGINE ASSY	1-17
ENGINE SPEED ADJUSTMENT	1-25
AIR CLEANER	1-28
RADIATOR	1-32
MUFFLER & EXHAUST PIPE	1-37
BATTERY	1-41
STARTING MOTOR	1-43
ALTERNATOR	1-44
ACCELERATOR PEDAL	1-46

GENERAL

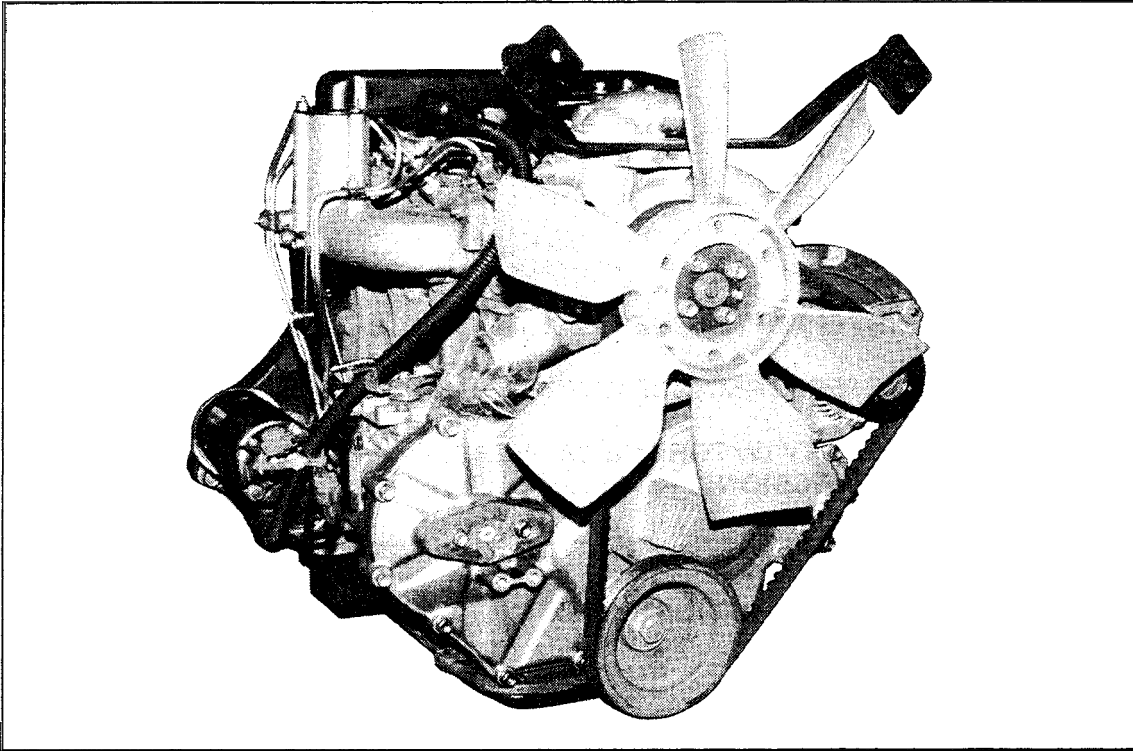

2J Engine Front View

LAP4-7

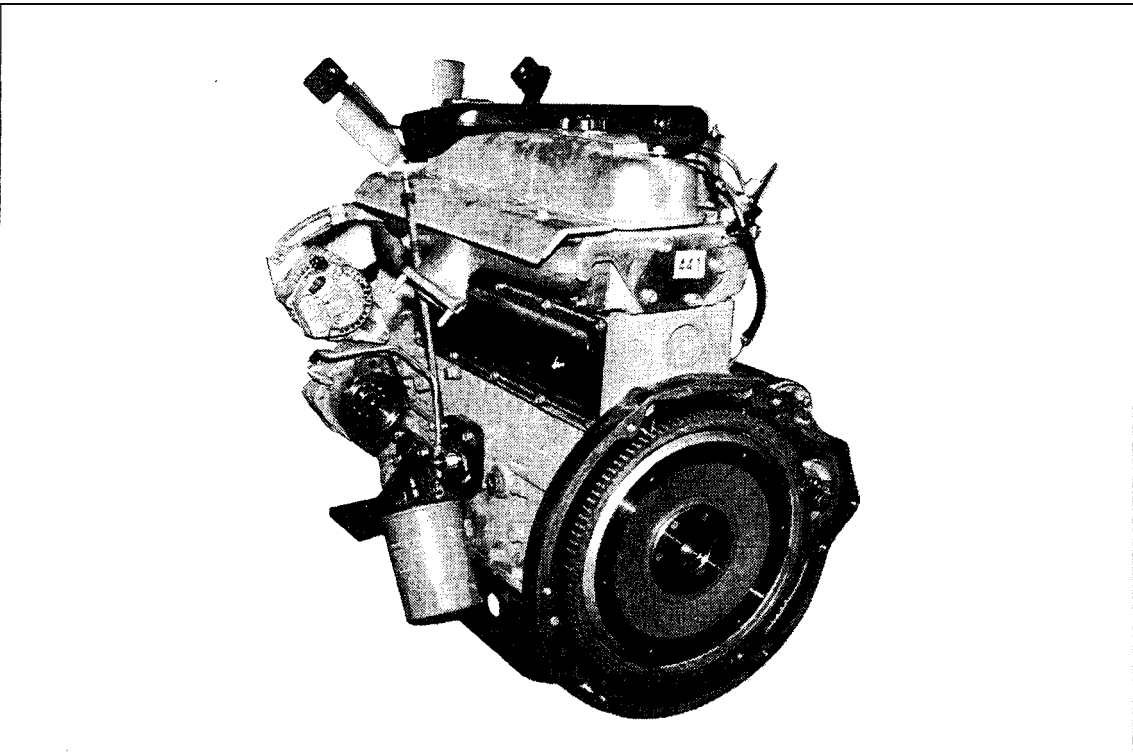

2J Engine Rear View

LAP4-5

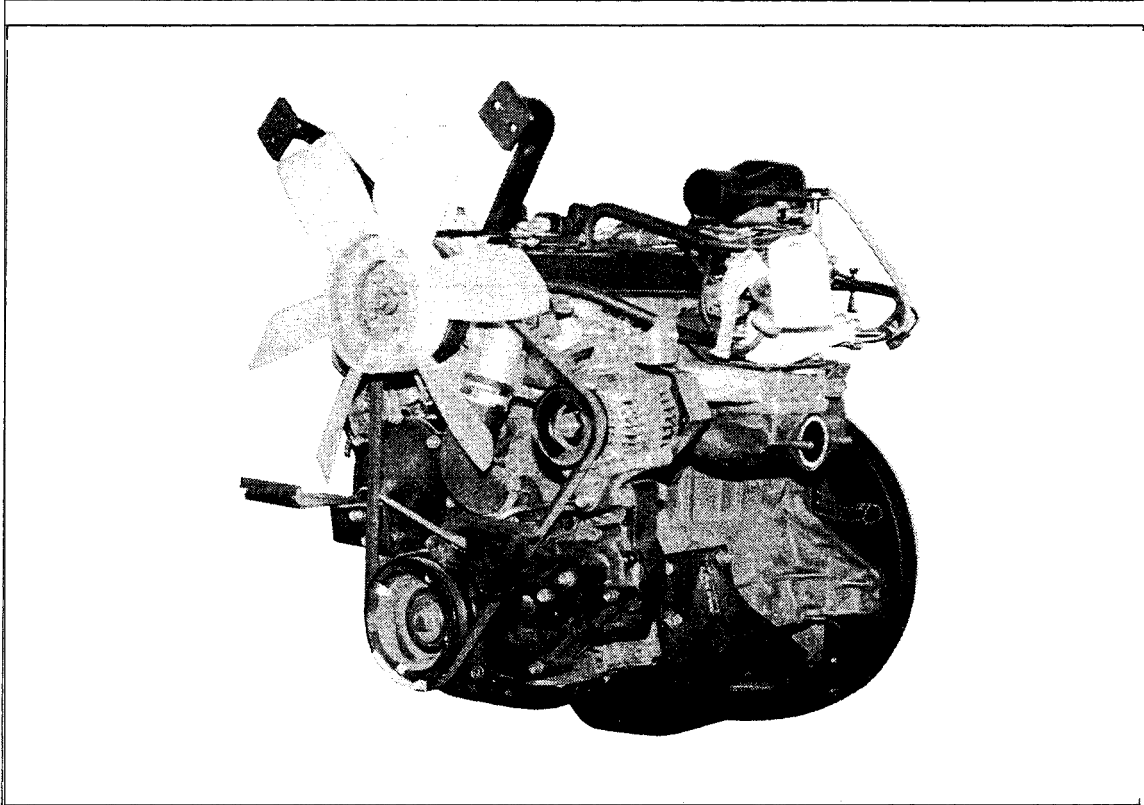

4Y Engine Front Righthand View

LAP14-16

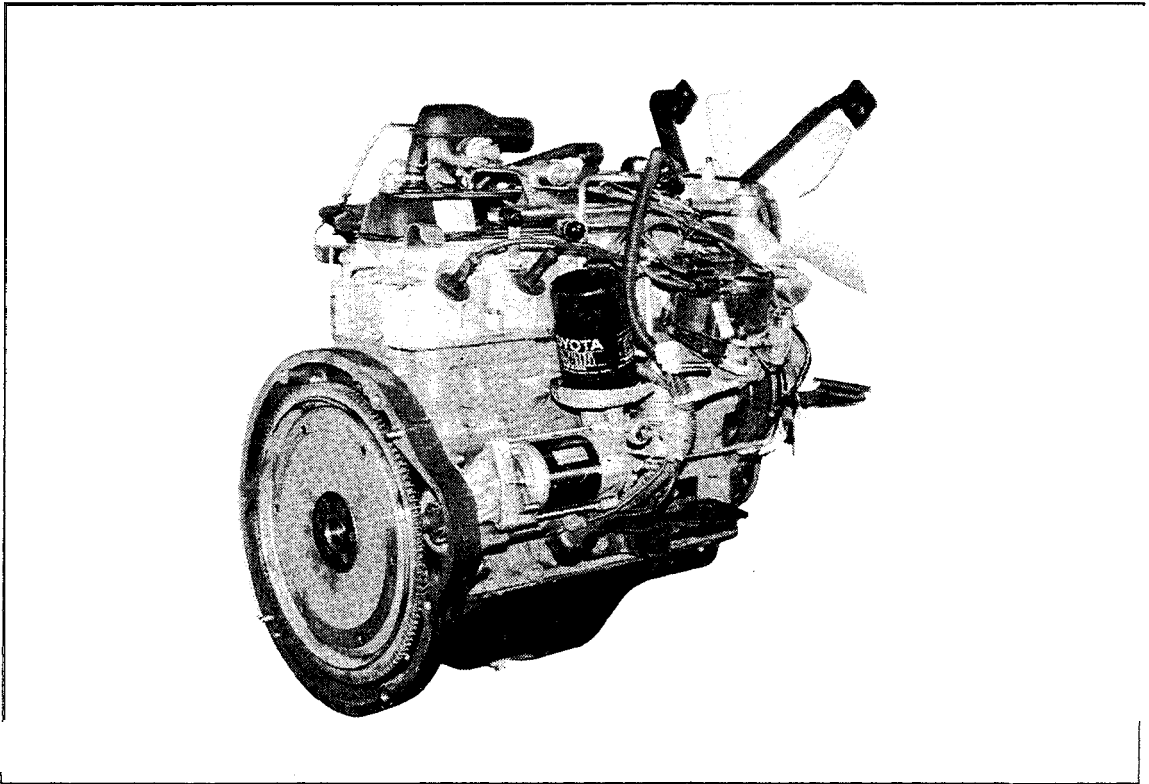

4Y Engine Rear Lefthand View

LAP14-15

ENGINE PERFORMANCE

	Engine type	Displacement (cc)	No-load static maximum speed (rpm)	Rated output PS/rpm	Maximum torque kg-m/rpm
2-ton series	4Y	2237	2700	54/2400	16.5/1800
	2J	2481	2600	50/2500	14.5/2200
3-ton series	4Y	2237	2700	54/2400	16.5/1800
	2J	2481	2600	50/2500	14.5/2200

ENGINE PERFORMANCE CURVES

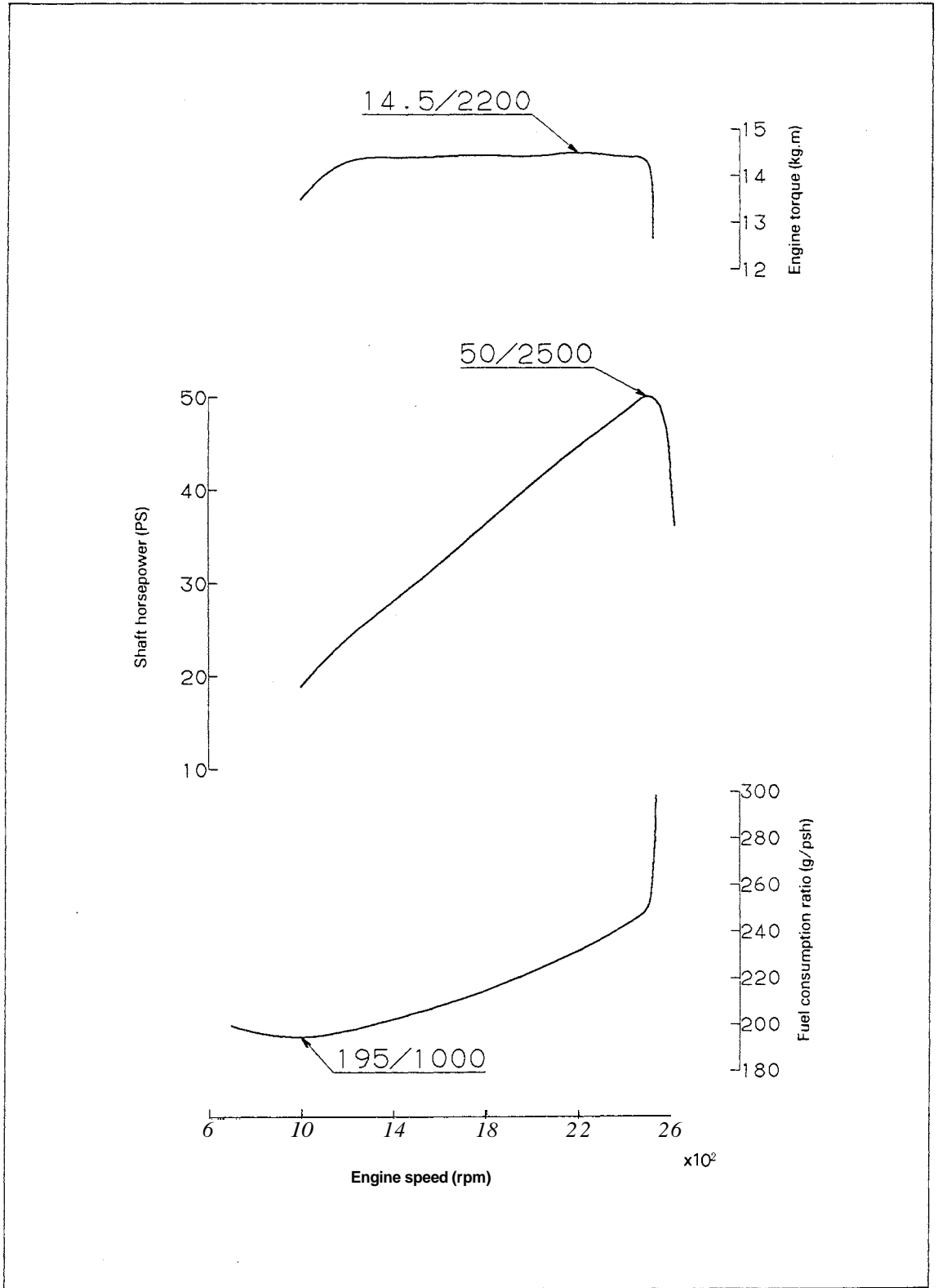

2J Engine Performance Curves

KAHM 19

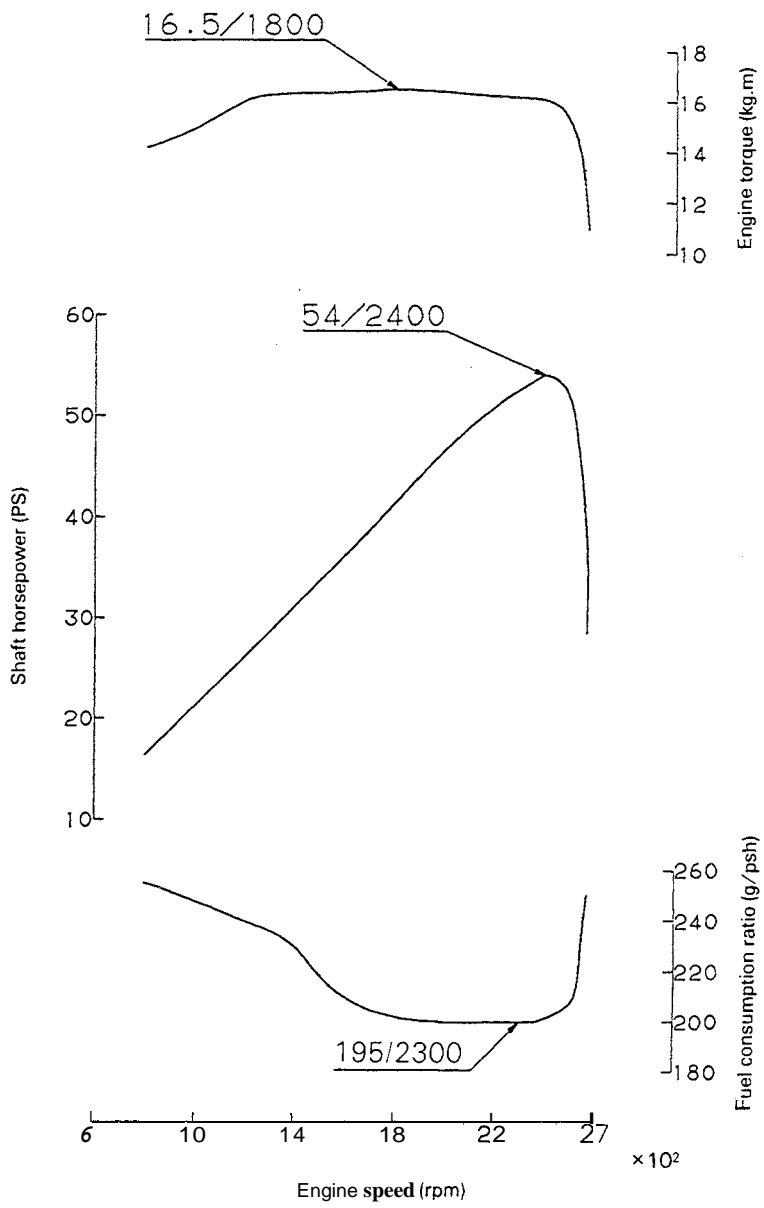

4Y Engine Performance Curves

LAOM 11

ENGINE ASSY W/TORQUE CONVERTER TRANSMISSION

REMOVAL

[2J ENGINE MODELS]

1. Engine hood removal
 - (1) Disconnect the engine hood damper from the frame bracket.
 - (2) Disconnect the engine hood stay from the frame bracket.
 - (3) Remove the engine hood hinge set screws (two on each side), and remove the engine hood.

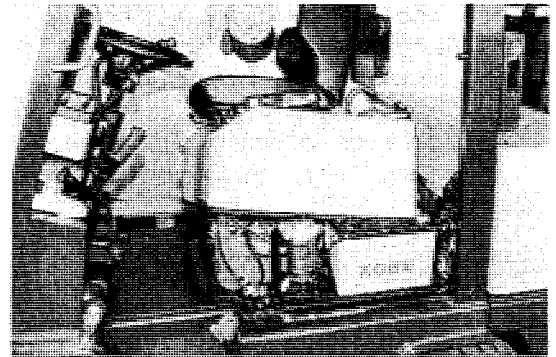

Removing the Engine Hood

LAP2-1

2. Toe board removal
3. Battery ASSY removal
 - (1) Disconnect the battery terminals

Caution:
Always disconnect the battery negative (-) terminal first.

- (2) Remove the battery stopper
- (3) Remove the battery ASSY.



Removing the Battery

LAP2-11

4. Battery case removal
 - (1) Remove the set bolts (2 pcs). and remove the battery.
5. Electrical wiring and fuel hose disconnection
 - (1) Disconnect the starting motor bond strap
 - (2) Disconnect electrical wirings such as the injection pump solenoid cut wiring
 - (3) Disconnect the fuel hose

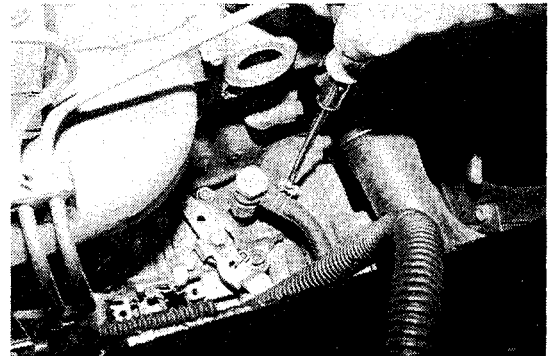

Disconnecting the Solenoid Cut Wiring

LAP2-13

6. Fuel filter ASSY removal
 - (1) Disconnect the fuel piping.
 - (2) Remove the set bolts (2 pcs.), and remove the fuel filter ASSY.

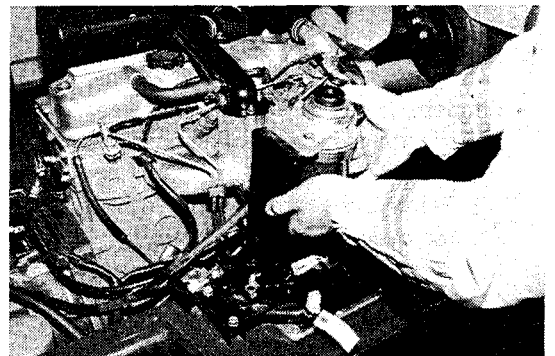

Removing the Fuel Filter

LSP2-16

7 Air cleaner ASSY removal

- (1) Remove the hydraulic tank breather
- (2) Loosen the hose clamp for the air cleaner hose
- (3) Remove the set bolts (4 pcs) of the air cleaner case, and remove the air cleaner ASSY

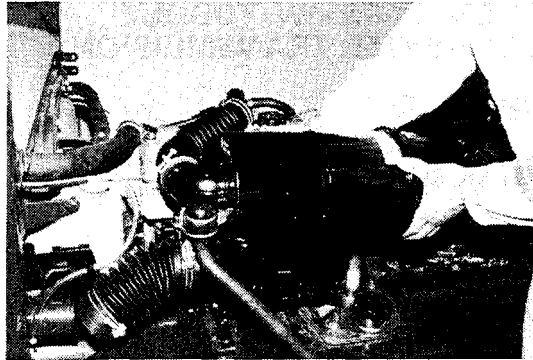

Removing the Air Cleaner

LAP2-26

8. Radiator cover removal

- (1) Remove the set knob, and remove the radiator cover.

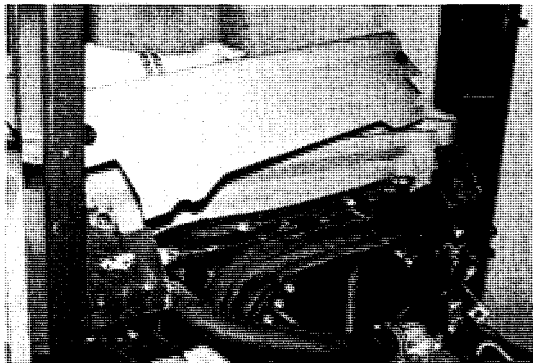

Removing the Radiator Cover

LAP2-28

9. Radiator reservoir tank removal

- (1) Disconnect the reservoir tank hose from the radiator.
- (2) Remove the reservoir tank.

10. Radiator ASSY removal

- (1) Loosen the radiator drain plug to drain the cooling water.
- (2) Loosen the engine drain plug to drain the cooling water.

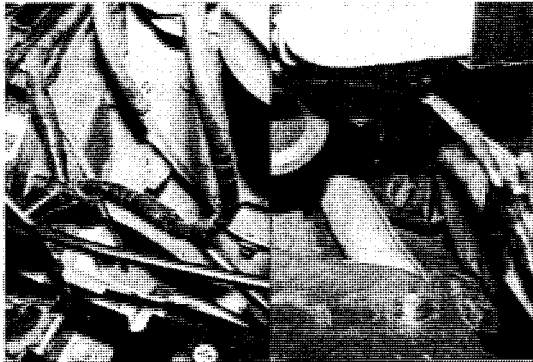

Cooling Water Drain Plugs

LAP2-33.31

- (3) Disconnect the torque converter cooler hose.

Caution:

Identify the hose connecting positions.

- (4) Remove the fan shroud set bolts. and remove the fan shroud ASSY.

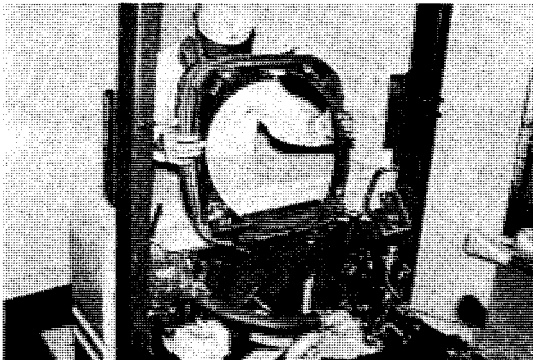

Removing the Fan Shroud

LAP3-7

-
- (5) Remove the radiator set bolts, and remove the radiator ASSY.

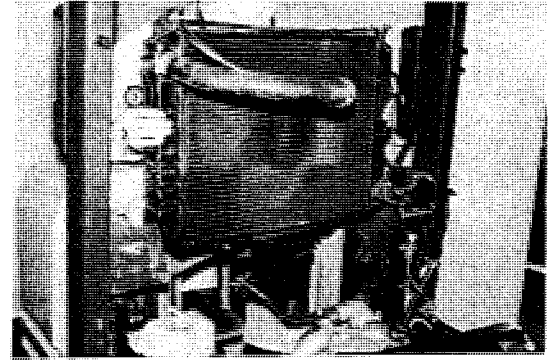

Removing the Radiator

LAP3-10

11. Exhaust pipe disconnection

- (1) Remove the flange set nuts (3 pcs.) and disconnect the exhaust pipe.

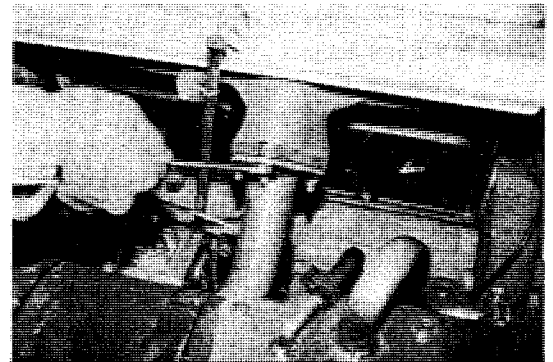

Disconnecting the Exhaust Pipe

LAP3-11

12. Accelerator flexible wire disconnection

- (1) Disconnect the wire clevis from the injection pump.
(2) Disconnect, the accelerator cable bracket from the manifold.

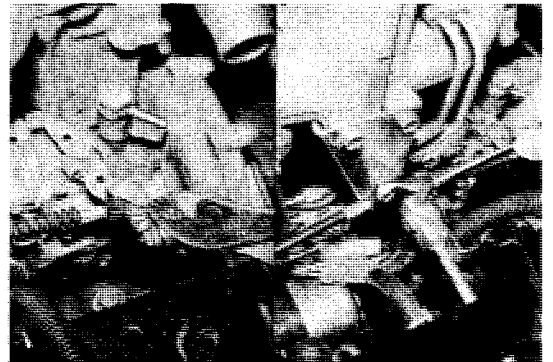

Disconnecting the Accelerator Wire

LAP3-13.14

13. Oil pump ASSY removal

- (1) Remove the oil pump set bolts (2 pcs.).
(2) Disconnect the oil pump ASSY from the engine.

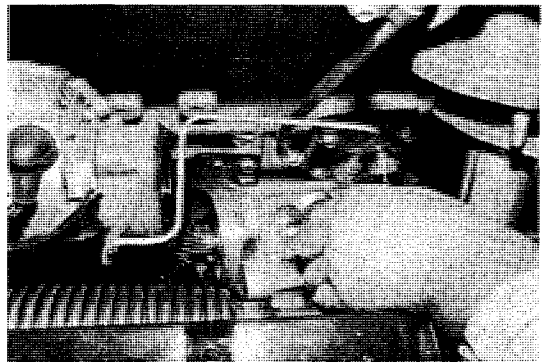

Removing the Oil Pump

LAP3-15

14. Accelerator pedal W/accelerator bracket removal

- (1) Remove the toe board set bolts, and remove the accelerator pedal W/accelerator bracket.

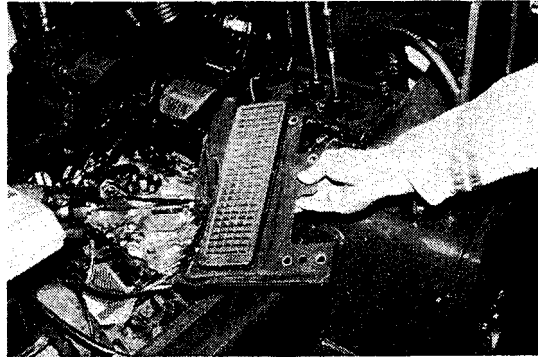

Removing the Accelerator Bracket

LAP3-17

15. Torque converter shift rod and inching wire disconnection.

- (1) Remove the set nut, and disconnect the shift rod.
- (2) Disconnect the clevis, loosen the wire set nut, and disconnect the inching wire.

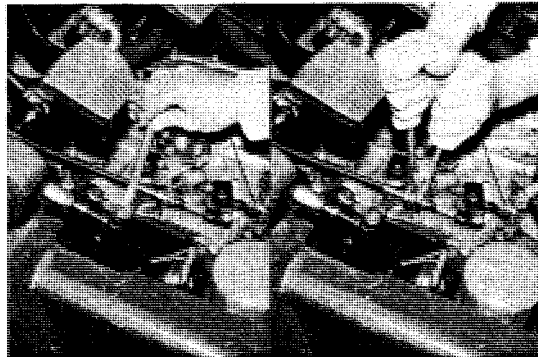

Disconnecting the Torque Converter Link Portion

LAP3-19.20

16. Propeller shaft ASSY disconnection

- (1) Remove the set bolts (2 pcs.), and remove the propeller shaft cover.
- (2) Remove the propeller shaft set bolts (4 pcs. on each side), and disconnect the propeller shaft.

Note:

The propeller shaft may be disconnected on either the differential side or the transmission side.



Disconnecting the Propeller Shaft

LAP1-4.8

17. Parking brake cable clamp removal

- (1) Remove the parking brake cable clamp set bolt, and disconnect the cable from the transmission case.

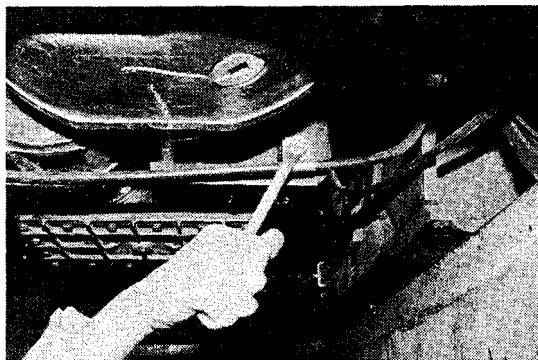

Disconnecting the Parking Brake Cable

LAP3-21

18. Mounting set bolt removal

- (1) Remove the engine mounting set bolts from the left and right sides.

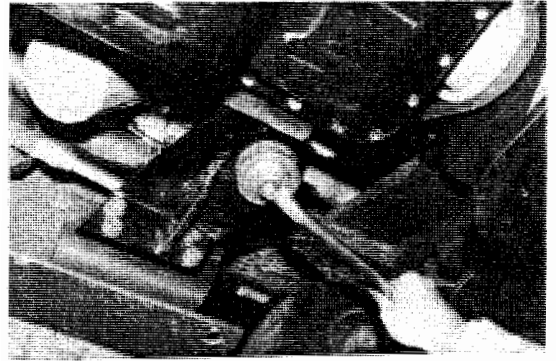

Removing the Set Bolts

LAP3-23

- (2) Remove the torque converter transmission mounting set bolts.

19. Check if any electrical wiring, cable or link is left connected.



Removing the Set Bolts

LAP3-22

20. Engine ASSY W/torque converter transmission removal

- (1) Use the SST and remove the engine ASSY W/transmission.
SST 09010-20111-71

Caution:

Carry out slinging in due consideration of the center-of-gravity position for safe operation.

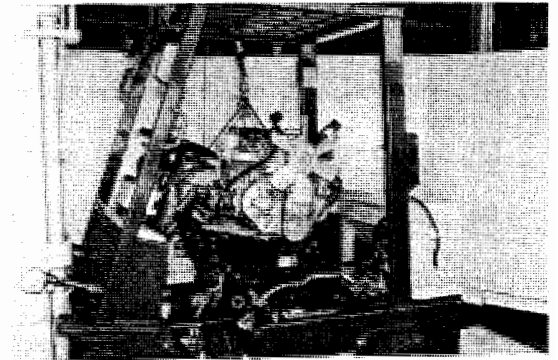

Removing the Engine

LAP3-24

[4Y ENGINE MODEL]

- 1 Engine hood removal
 - (1) Disconnect the engine hood damper from the frame bracket
 - (2) Disconnect the engine hood stay from the frame bracket
 - (3) Remove the engine hood hinge set bolts (2 pcs. on each side), and remove the engine hood

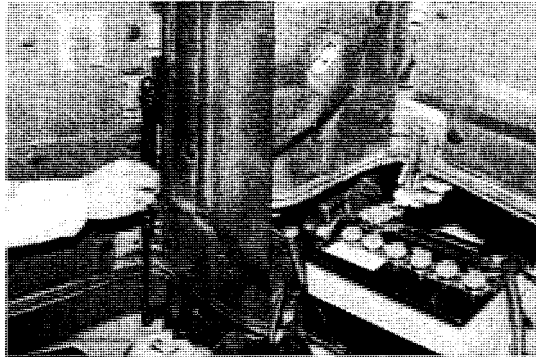

Removing the Engine Hood

LAP12-9.10

- 2 Radiator cover and toe board removal
3. Battery ASSY removal
 - (1) Disconnect the battery terminals.

Caution:

Always disconnect the battery negative (-) terminal first.

- (2) Remove the battery stopper
- (3) Remove the battery ASSY.

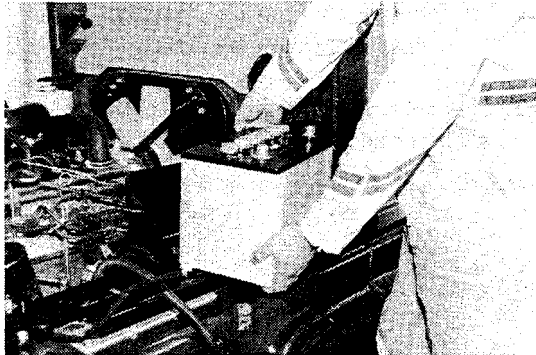

Removing the Battery

LAP12-17

4. Battery case removal
 - (1) Remove the set bolts (3 pcs.), and remove the battery case.
- 5 Electrical wiring and fuel hose disconnection
 - (1) Disconnect the starting motor bond strap
 - (2) Disconnect the connector of each electrical wiring
 - (3) Disconnect the fuel hose

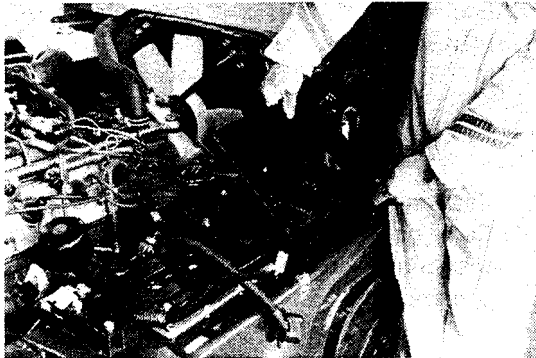

Removing the Battery Case

LAP12-19

6. Horn ASSY removal
 - (1) Disconnect the wiring at the connector.
 - (2) Remove the set bolts (2 pcs.) and remove the horn ASSY.

7. Air cleaner ASSY removal
 - (1) Remove the hydraulic tank breather.
 - (2) Loosen the hose clamp for the air cleaner hose.
 - (3) Remove the air cleaner case set bolts (4 pcs.), and remove the air cleaner ASSY.

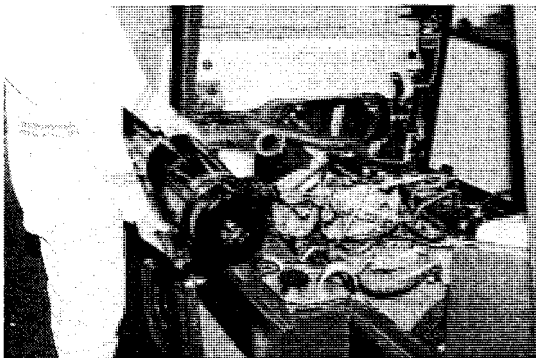

Removing the Air Cleaner

LAP12-27

**Thank you very much
for your reading.**

Please Click Here

**Then Get More
Information.**